



Parker Living®  
HORIZON

# MCHA#834

MODEL : SOFA DUAL REC MANUAL WITH  
DROP DOWN CONSOLE

## ASSEMBLY INSTRUCTIONS

## NOTICE DE MONTAGE

\* Please keep these instructions and have the product model # and part # available when requesting a service.

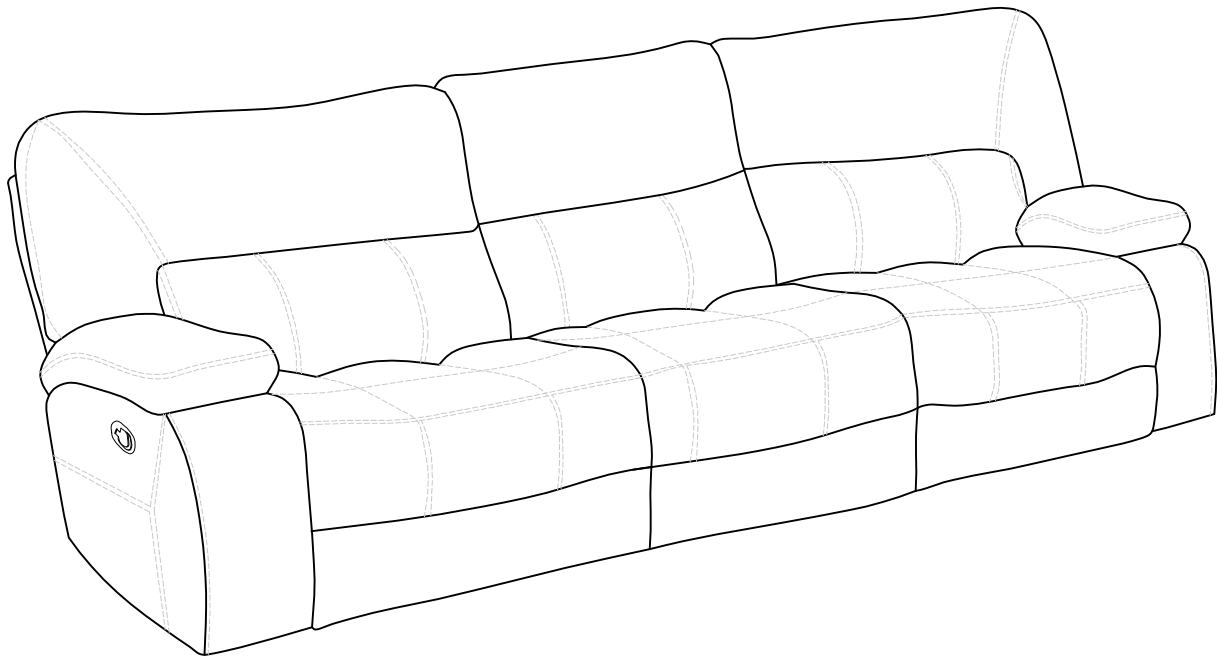

### IMPORTANT NOTE

Do not use a power tool to assemble this product as it could damage the thread of the hardware and affect the solidity/durability of the product.

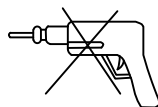

**A x 1**

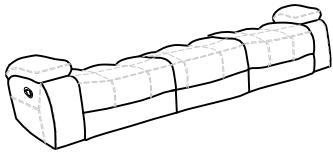

**B x 1**

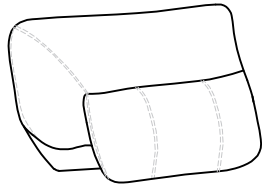

**C x 1**

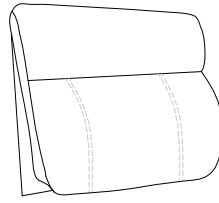

**D x 1**

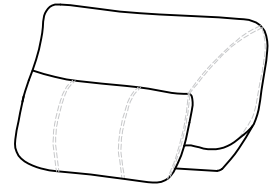

**STEP 1**

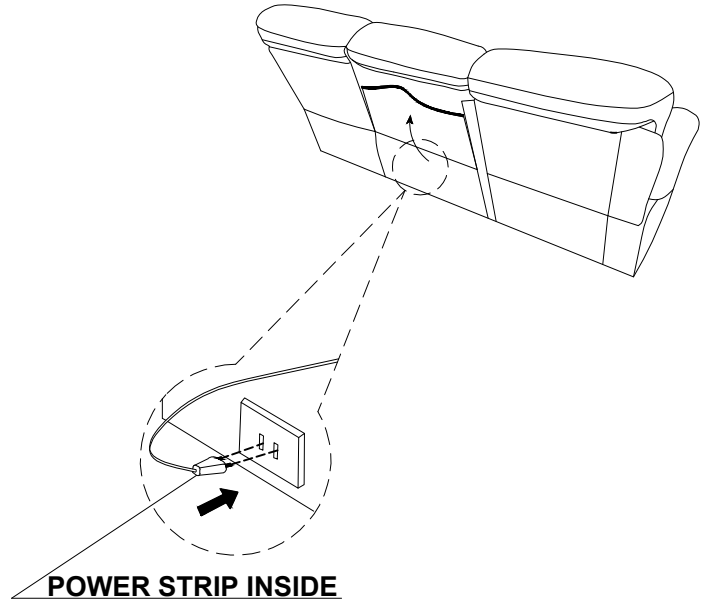
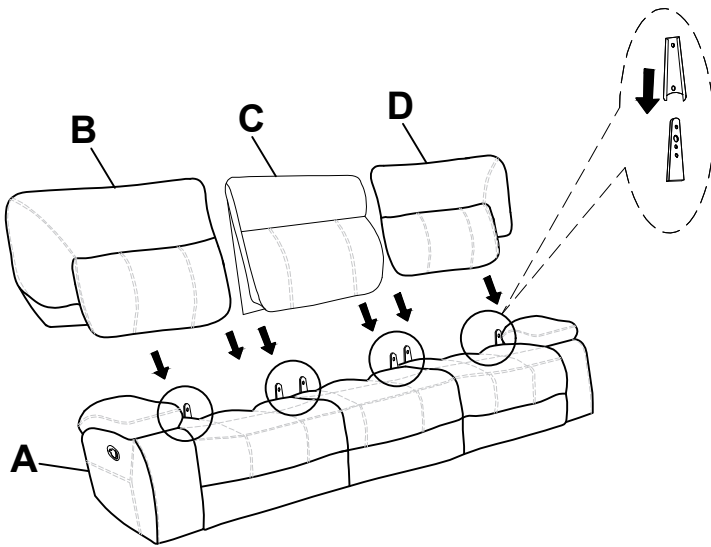

**STEP 2**

