



Parker Living®
HORIZON

MODEL : CANTERBURY MCAN#812PHZ

ASSEMBLY INSTRUCTIONS NOTICE DE MONTAGE

* Please keep these instructions and have the product model # and part # available when requesting a service.

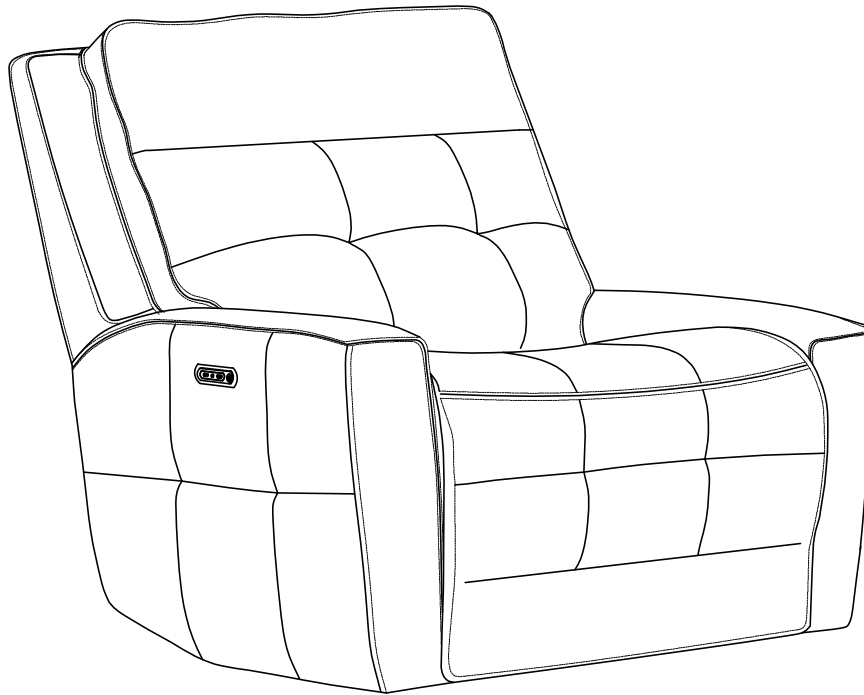

IMPORTANT NOTE

Do not use a power tool to assemble this product as it could damage the thread of the hardware and affect the solidity/durability of the product.

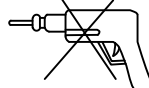

MADE IN VIET NAM

Page 1 of 2

A x 1

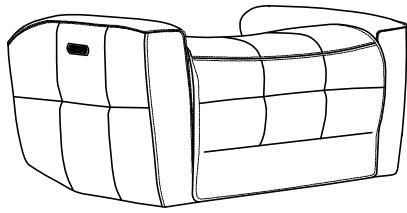

B x 1

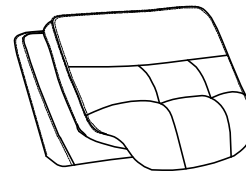

STEP 1

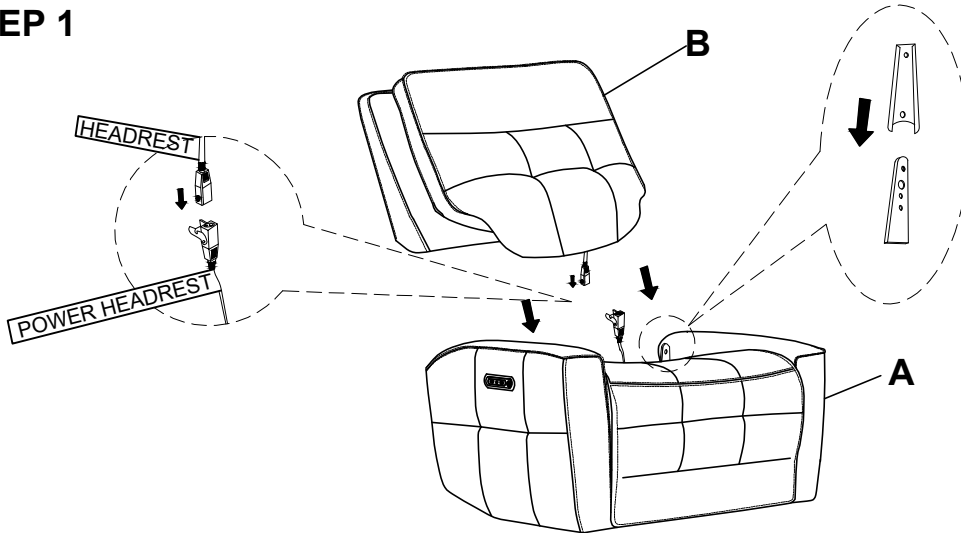

STEP 2

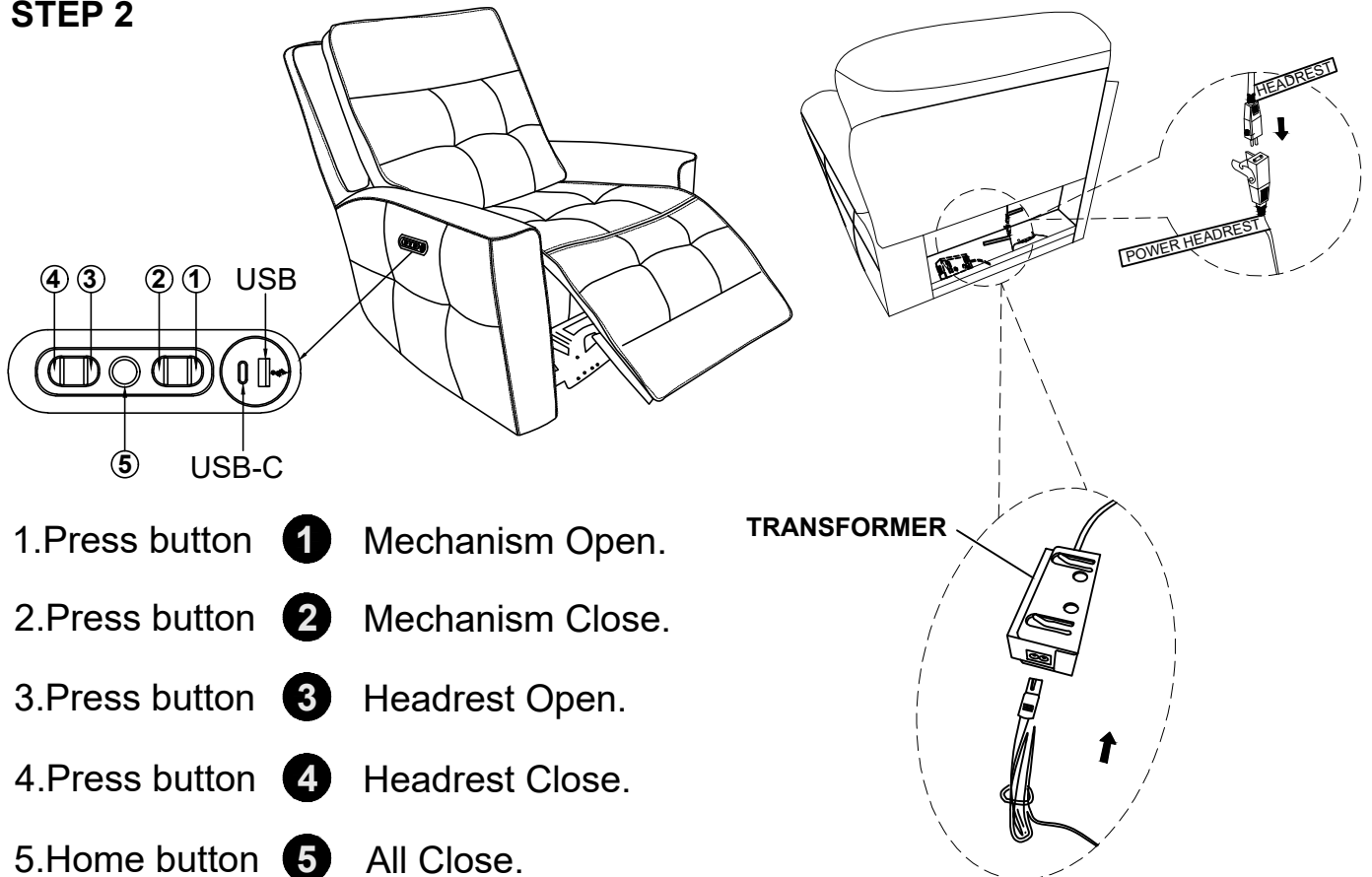

- 1. Press button **1** Mechanism Open.
- 2. Press button **2** Mechanism Close.
- 3. Press button **3** Headrest Open.
- 4. Press button **4** Headrest Close.
- 5. Home button **5** All Close.



Parker Living®
HORIZON

MODEL : CANTERBURY MCAN#822PHZ

ASSEMBLY INSTRUCTIONS NOTICE DE MONTAGE

* Please keep these instructions and have the product model # and part # available when requesting a service.

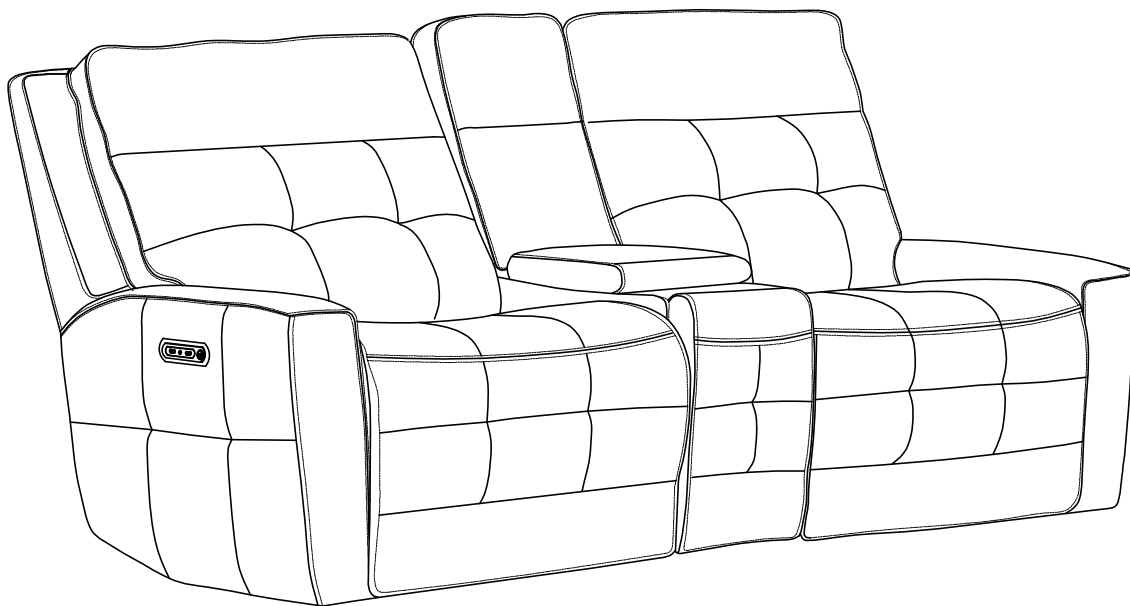

IMPORTANT NOTE

Do not use a power tool to assemble this product as it could damage the thread of the hardware and affect the solidity/durability of the product.

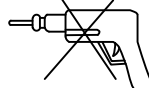

MADE IN VIET NAM

Page 1 of 3

A x 1

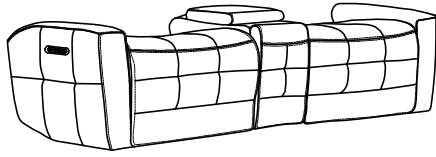

B x 1

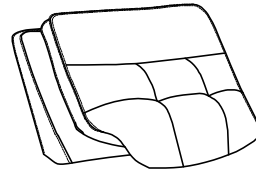

C x 1

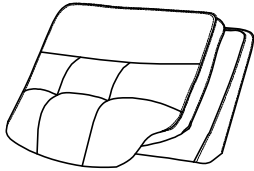

D x 1

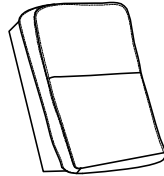

E x 2

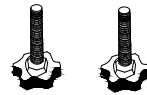

STEP 1

TRANSFORMER

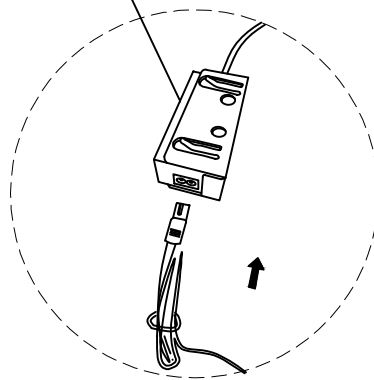

The location of the console backrest

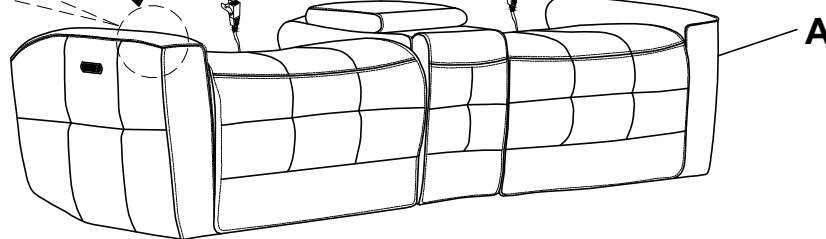
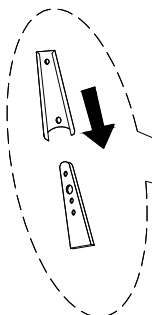
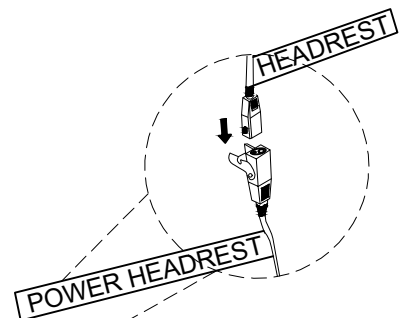
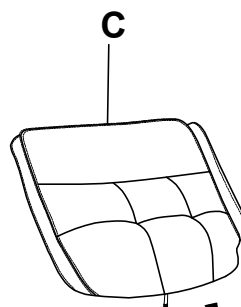
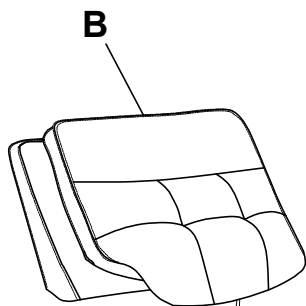
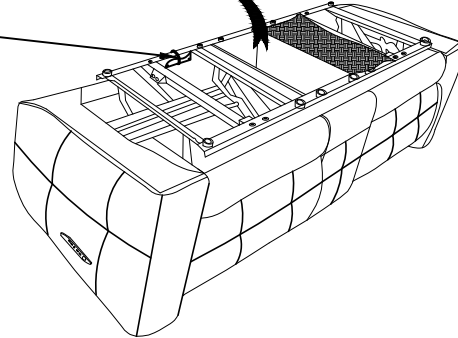
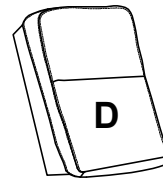

STEP 2

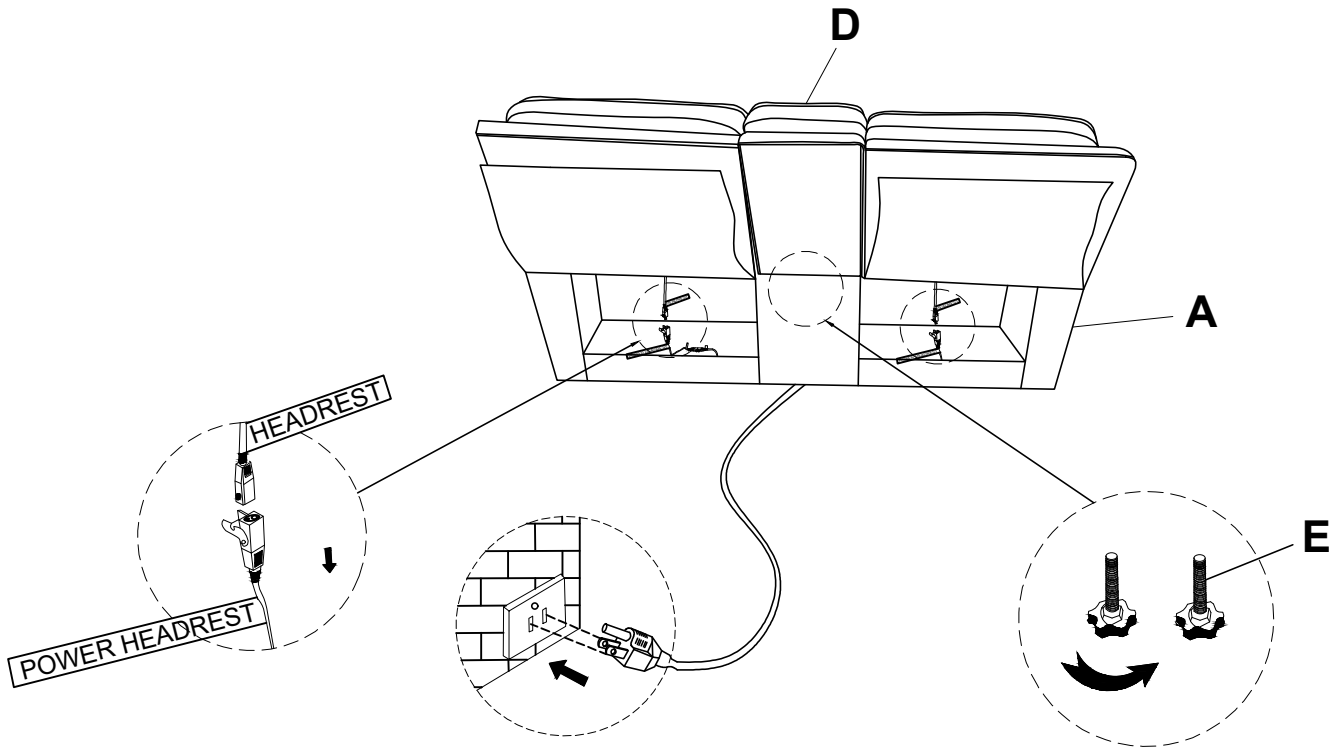

STEP 3

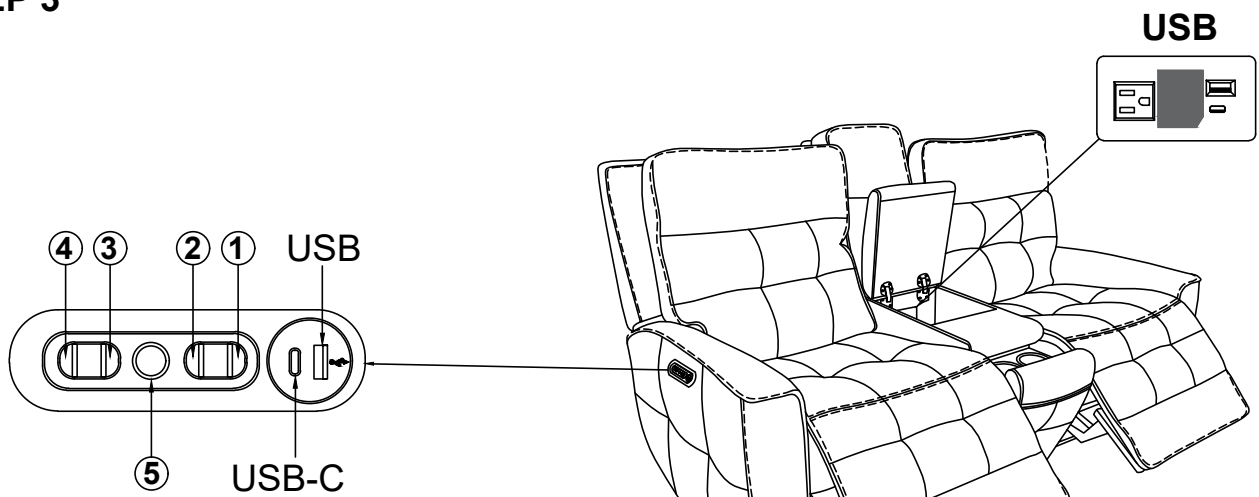

1. Press button **1** Mechanism Open.
2. Press button **2** Mechanism Close.
3. Press button **3** Headrest Open.
4. Press button **4** Headrest Close.
5. Home button **5** All Close.



Parker Living®
HORIZON

MODEL : CANTERBURY MCAN#822PHZ

ASSEMBLY INSTRUCTIONS NOTICE DE MONTAGE

* Please keep these instructions and have the product model # and part # available when requesting a service.

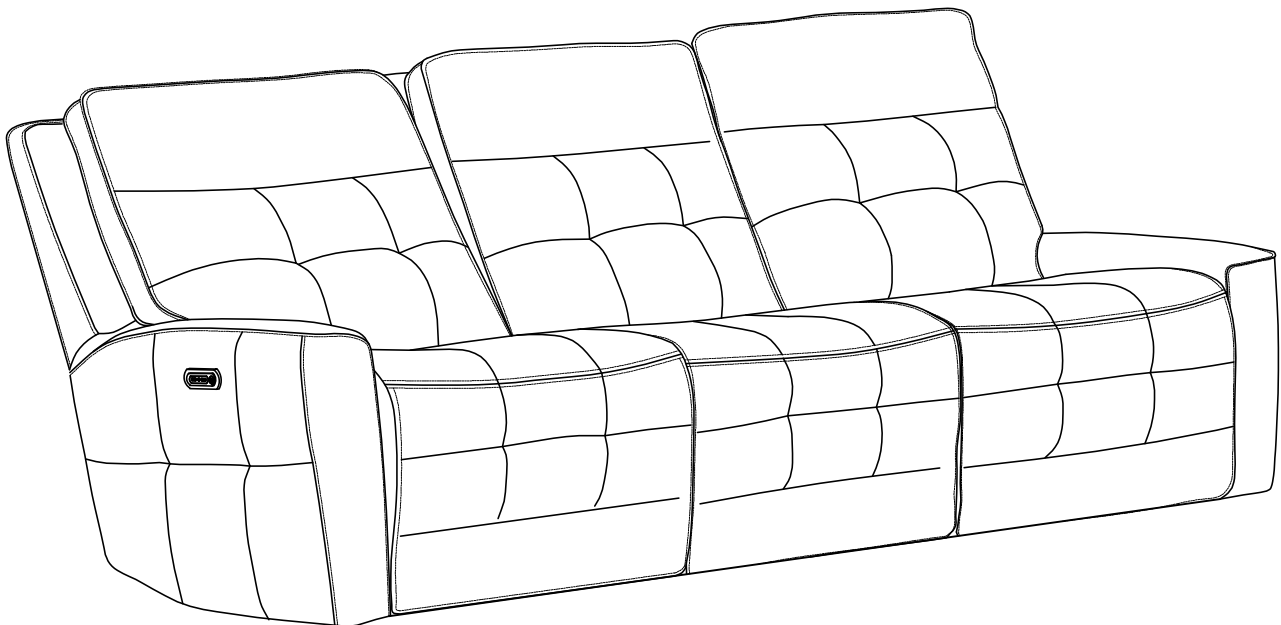

IMPORTANT NOTE

Do not use a power tool to assemble this product as it could damage the thread of the hardware and affect the solidity/durability of the product.

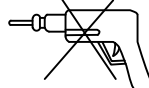

MADE IN VIET NAM

Page 1 of 2

