

# Assembly Instruction

Item NO:BOCA

1/8

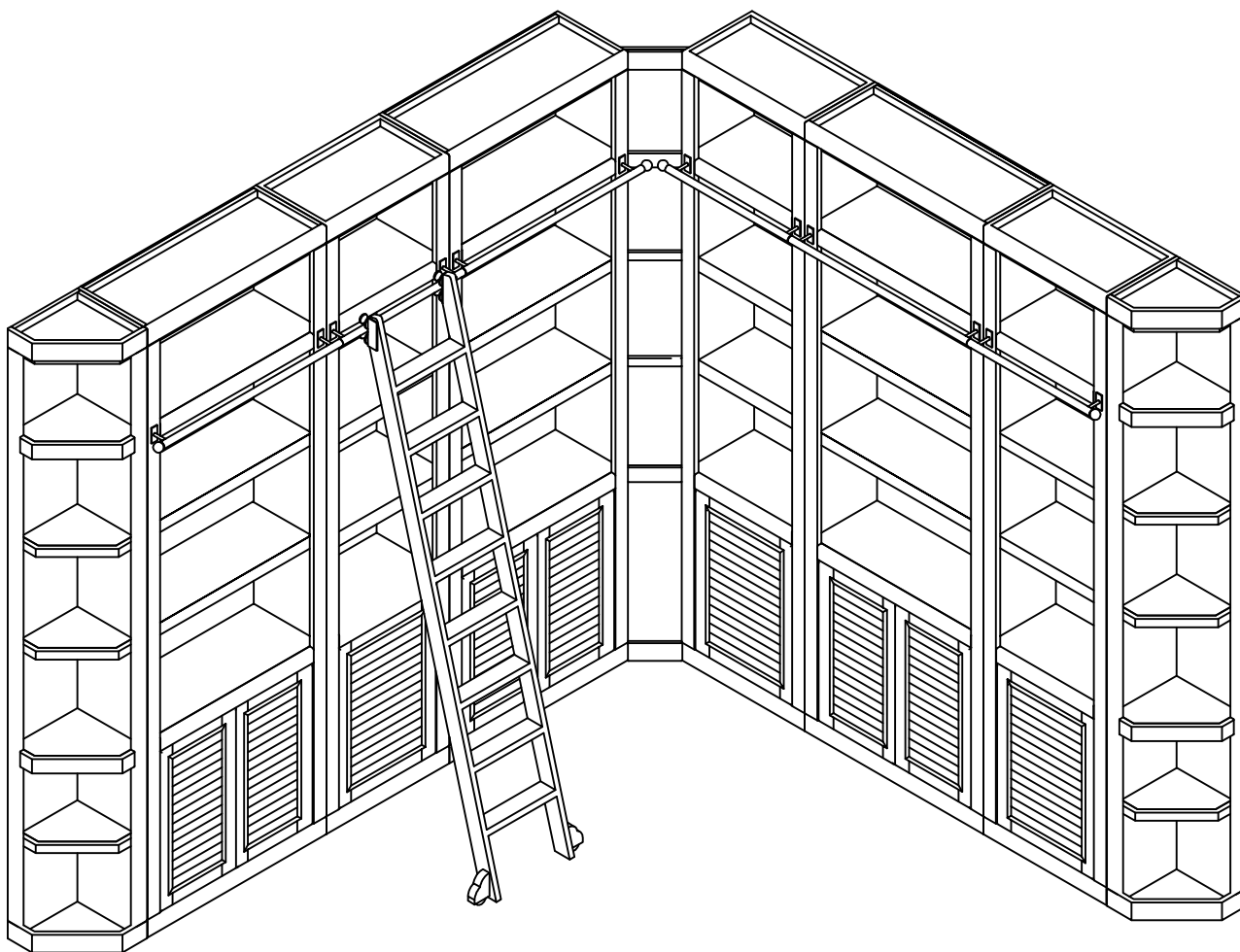















# Assembly Instruction

Item NO:BOC-430

2/8

## Hardwares

NO	Description	Sketch	Q'TY
A	Allen key		1pc
B	Allen key		1pc
C	28mm Bolt		6pcs
D	Screw Cap		6pcs
E	Matal ball		1pc
F	Sleeve		1pc
G	Screw		2pcs

NO	Description	Sketch	Q'TY
H	wood plug		4pcs
I	3/4" Bolt		4pcs
J	Ladder rail		1pc
K	3/4" Bolt		4pcs
L	Decorative bolt head		4pcs
M	Plastic cap		4pcs
	Touch up Pen		1pc

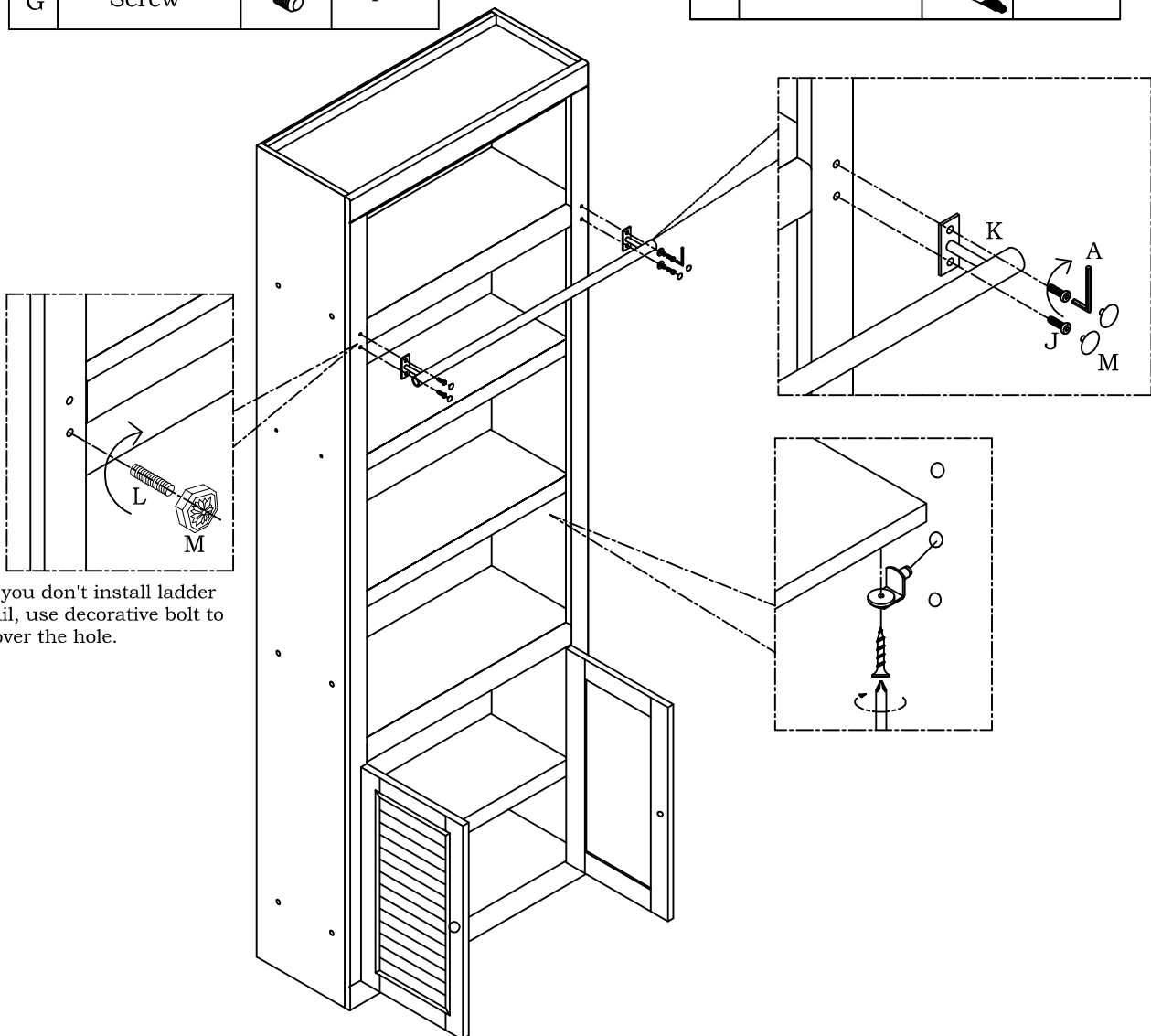









If you don't install ladder rail, use decorative bolt to cover the hole.

# Assembly Instruction

Item NO:BOC-430

3/8

NO	Description	Sketch	Q'TY
A	Allen key		1pc
B	Allen key		1pc
C	28mm Bolt		6pcs
D	Screw Cap		6pcs
E	Matal ball		1pc

NO	Description	Sketch	Q'TY
F	Sleeve		1pc
G	Screw		2pcs
H	wood plug		4pcs

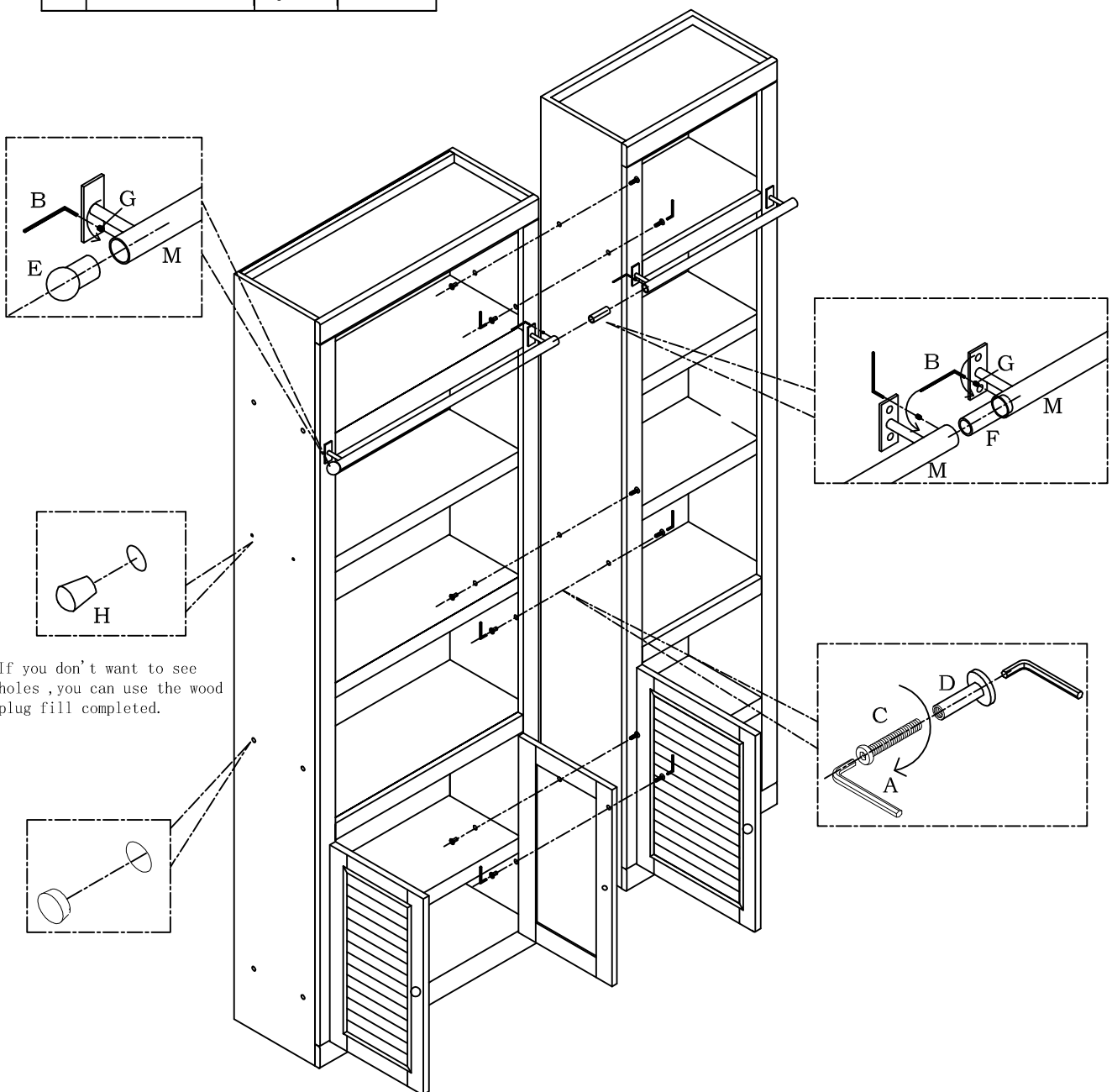







If you don't want to see holes, you can use the wood plug fill completed.







# Assembly Instruction

Item NO:BOC-420

4/8

## Hardwares

NO	Description	Sketch	Q'TY
A	Allen key		1pc
B	Allen key		1pc
C	28mm Bolt		6pcs
D	Screw Cap		6pcs
E	Matal ball		1pc
F	Sleeve		1pc
G	Screw		2pcs

NO	Description	Sketch	Q'TY
H	wood plug		4pcs
I	3/4" Bolt		4pcs
J	Ladder rail		1pc
K	3/4" Bolt		4pcs
L	Decorative bolt head		4pcs
M	Plastic cap		4pcs
	Touch up Pen		1pc

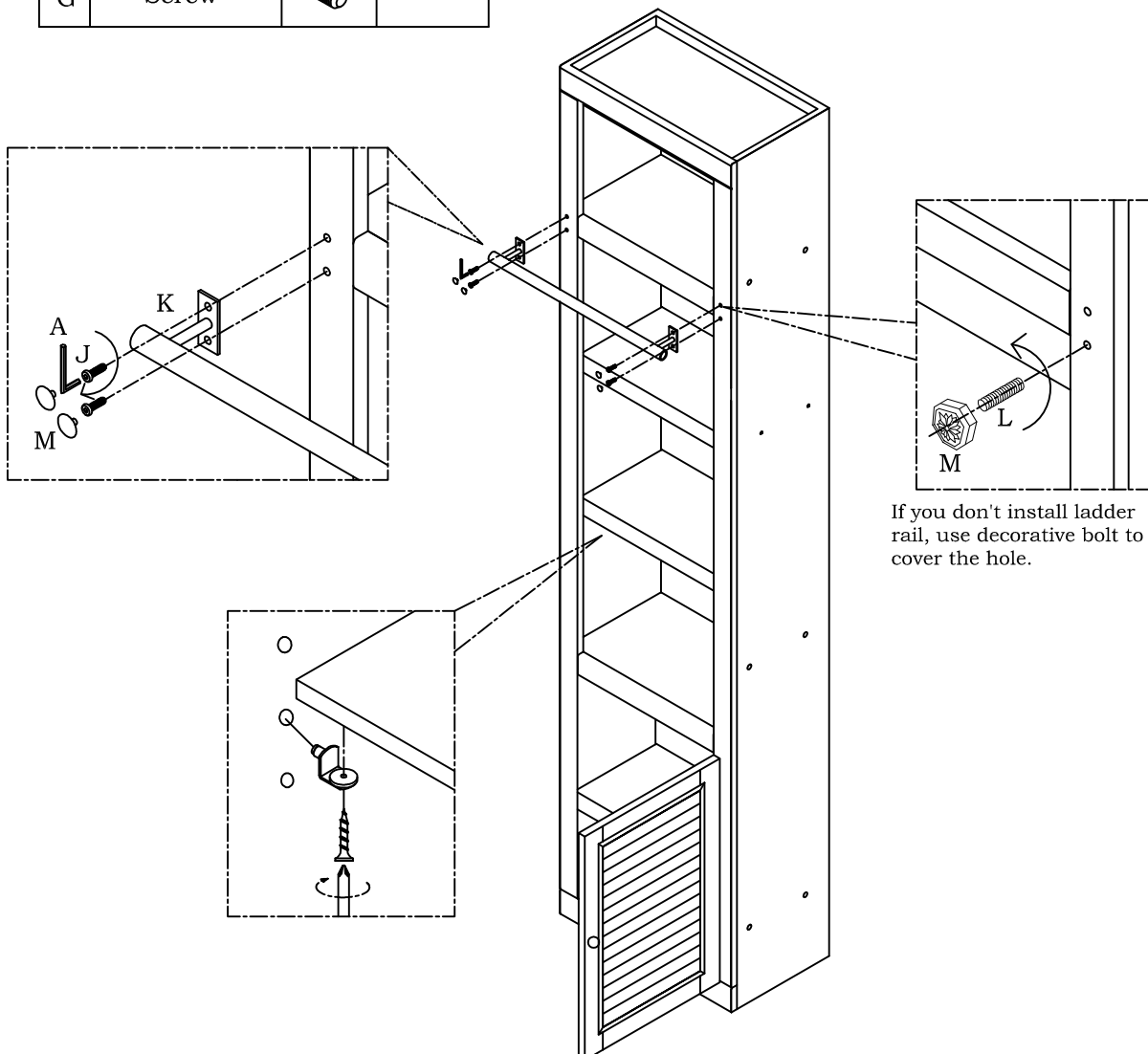









If you don't install ladder rail, use decorative bolt to cover the hole.

# Assembly Instruction

Item NO:BOC-420

5/8

NO	Description	Sketch	Q'TY
A	Allen key		1pc
B	Allen key		1pc
C	28mm Bolt		6pcs
D	Screw Cap		6pcs
E	Matal ball		1pc

NO	Description	Sketch	Q'TY
F	Sleeve		1pc
G	Screw		2pcs
H	wood plug		4pcs

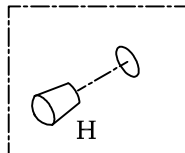
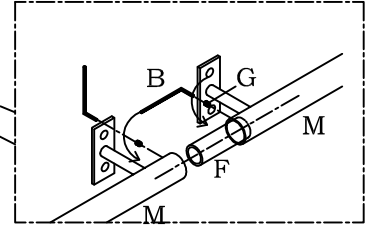
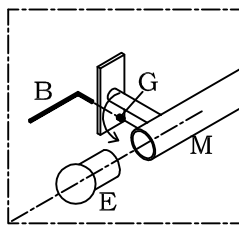

If you don't want to see holes, you can use the wood plug fill completed.

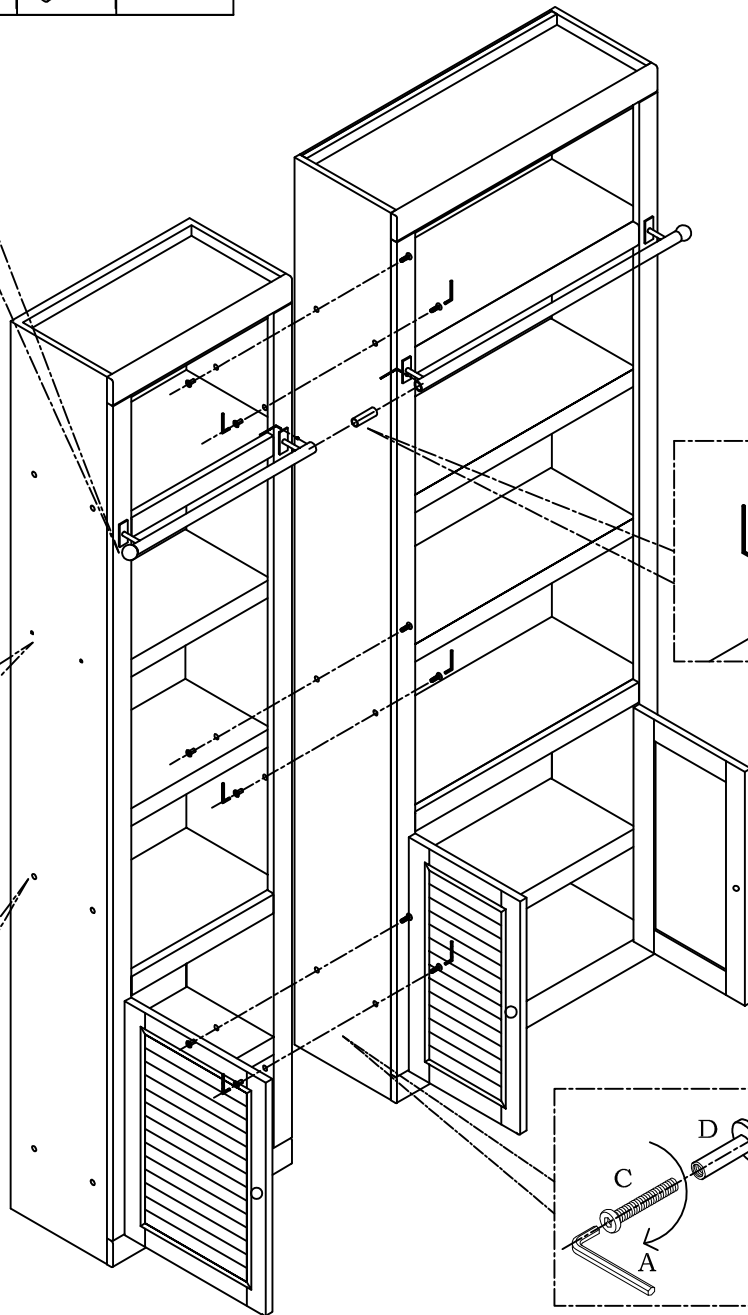
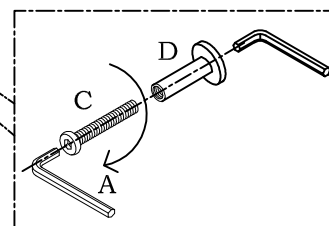
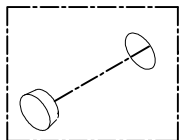





# Assembly Instruction

Item NO:BOC-456/430/420

6/8

## Hardwares

NO	Description	Sketch	Q'TY
A	Allen key	 4MM	1pc
B	Allen key	 2.5MM	1pc
C	28mm Bolt		6pcs
E	Matal ball		1pc
G	Screw		2pcs

Corner Filler must be fully attached to one Bookcase and placed in its final position before being secured to a second Bookcase.

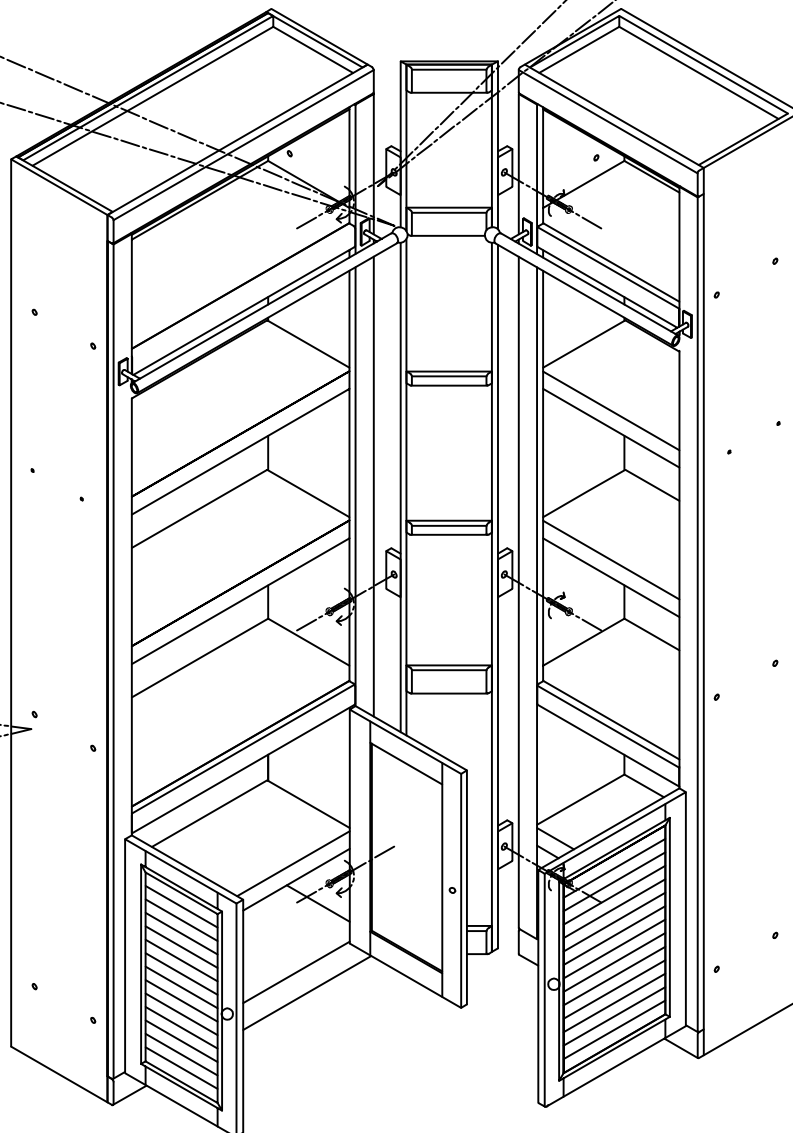
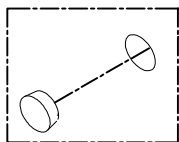
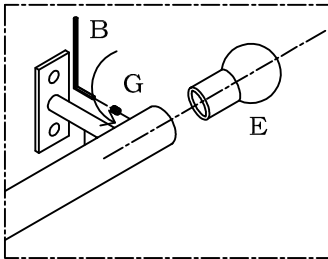
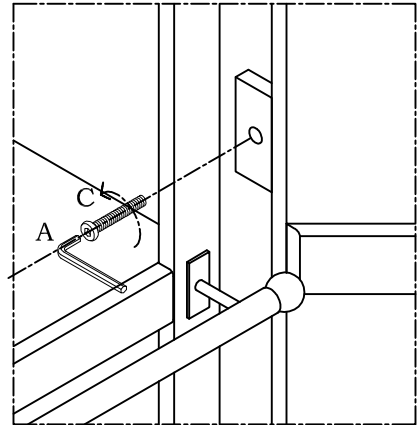





# Assembly Instruction

Item NO:BOC-450

7/8

## Hardwares

NO	Description	Sketch	Q'TY
A	Allen key	 4MM	1pc
B	28mm Bolt		6pcs
C	Screw Cap		6pcs
	Touch up Pen		1pc

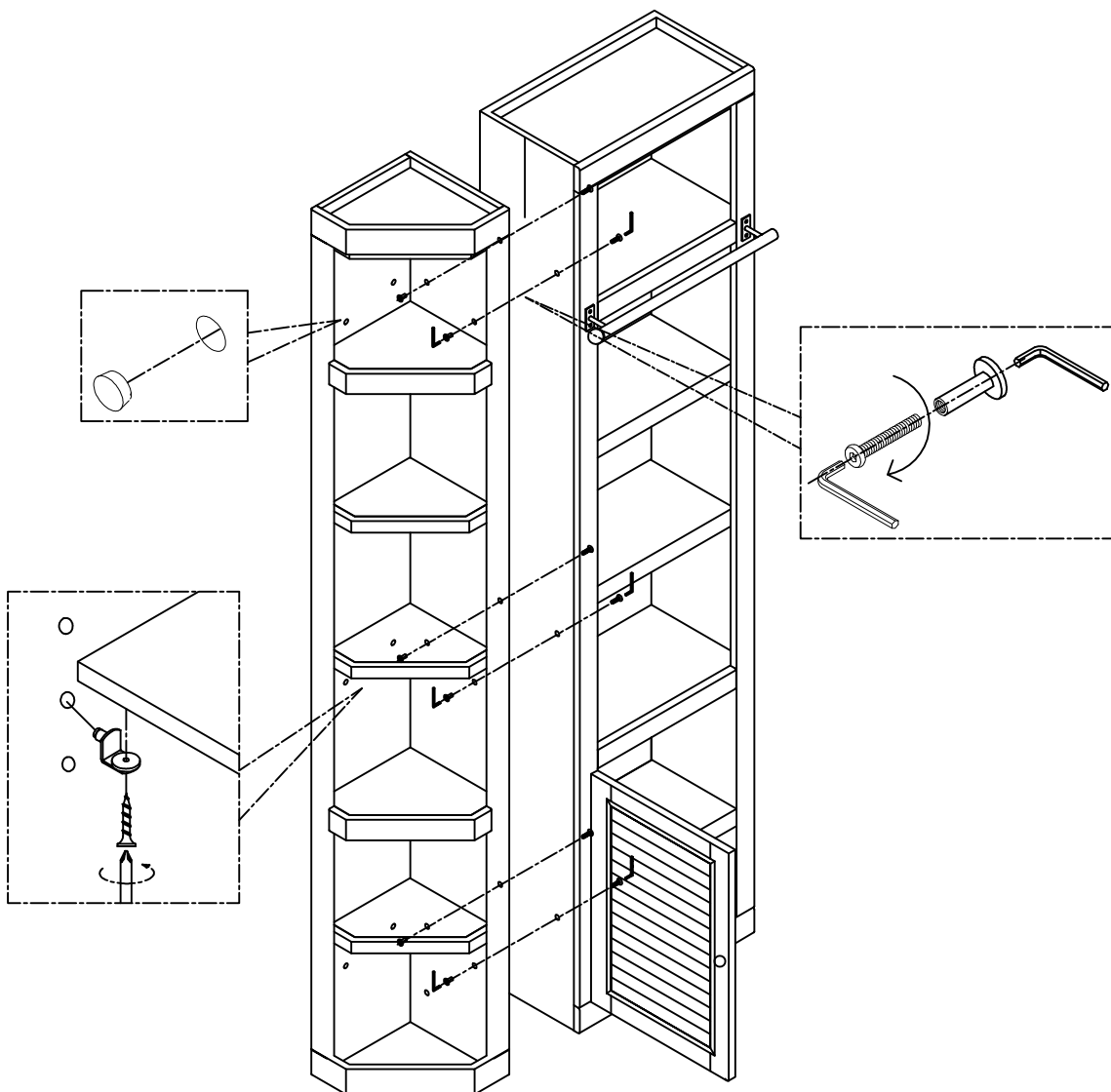

# Assembly Instruction

Item NO:BOC-495

8/8

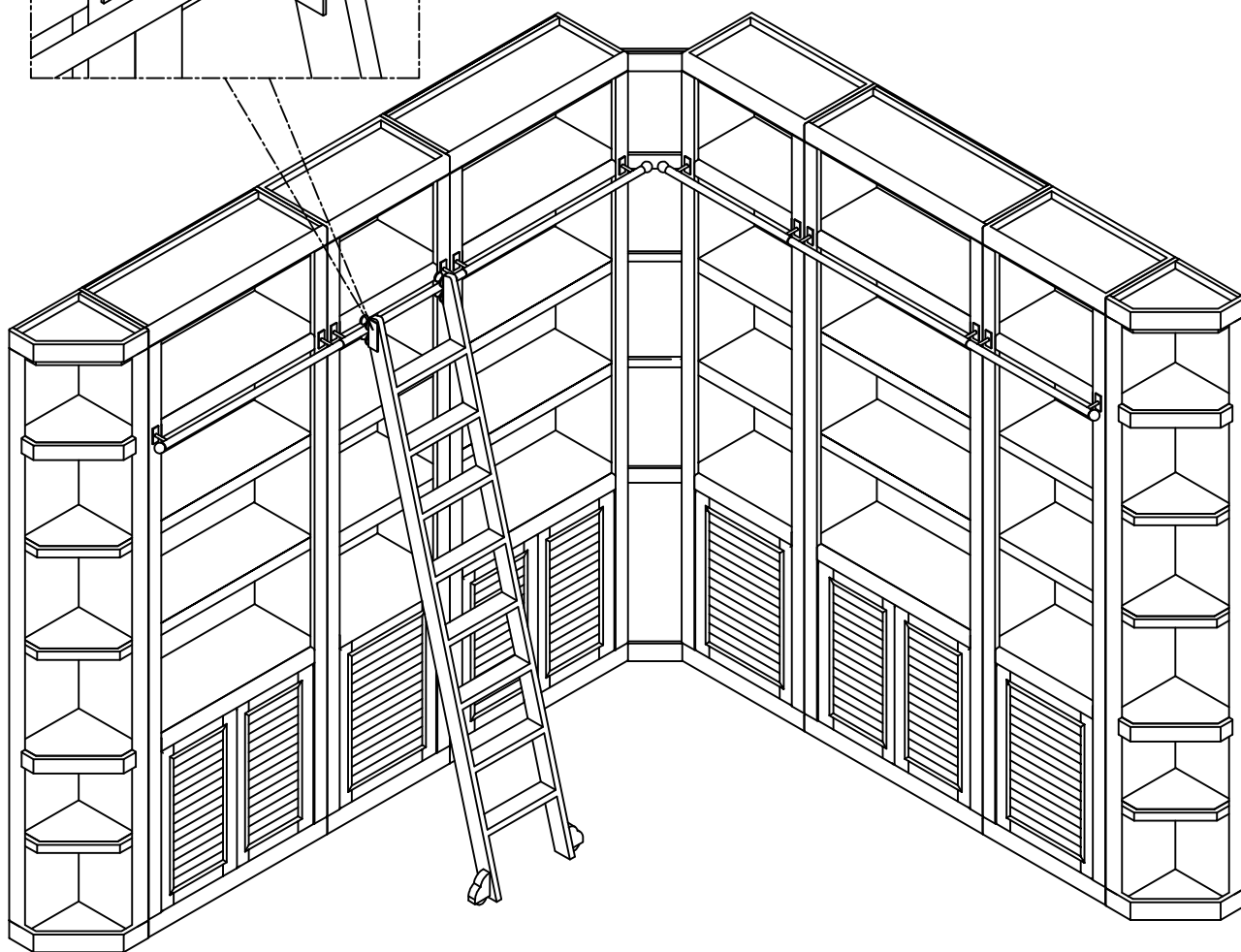
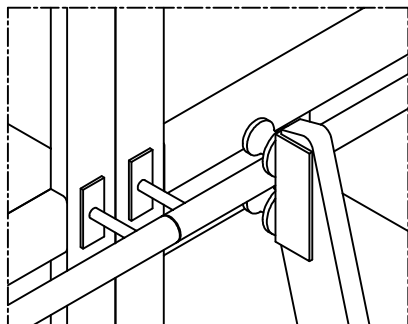









# Assembly Instruction

Item NO:BOC-485

1/2

## Hardwares

NO	Description	Sketch	Q'TY
A	Allen key	 5MM	1pc
B	2" Bolt		8pcs
C	Flat washer		8pcs
D	Spring washer		8pcs
E	Wire lid		1pc
	Touch up Pen		1pc

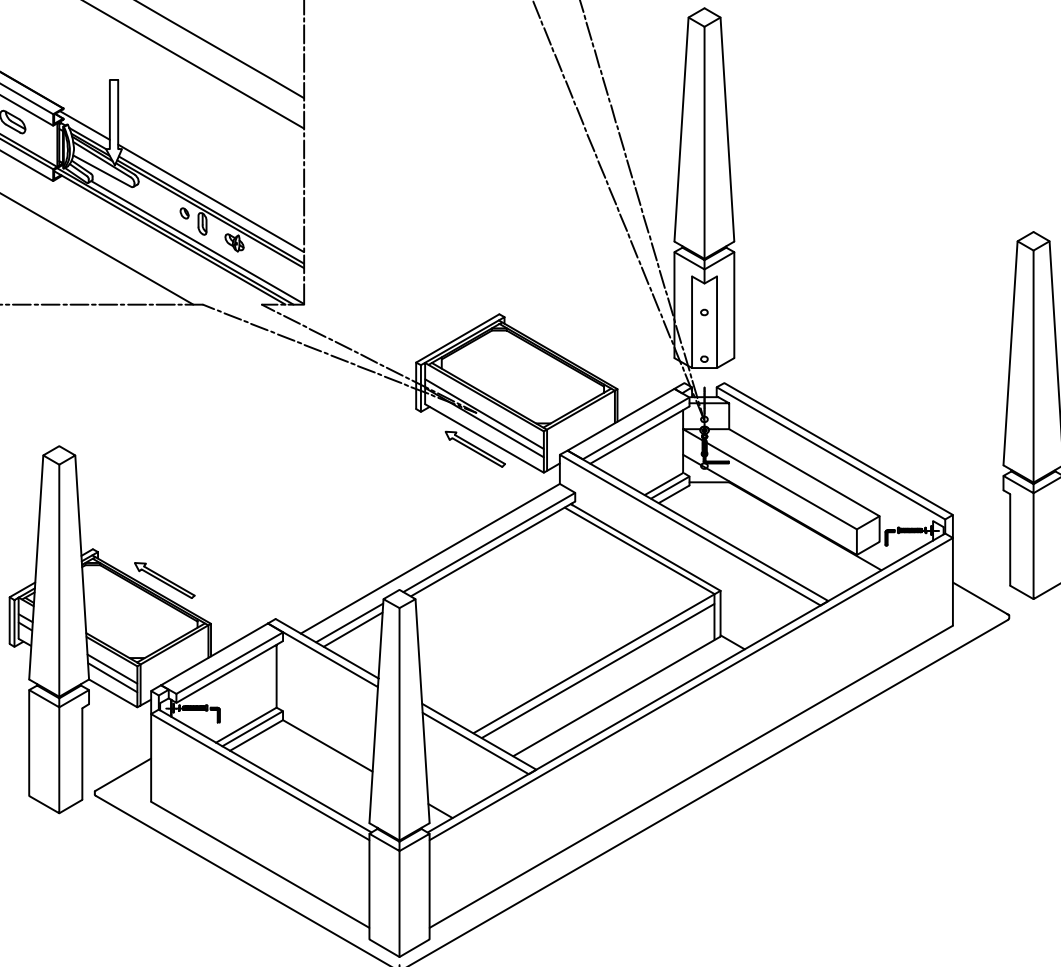
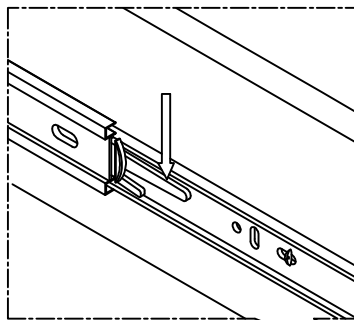
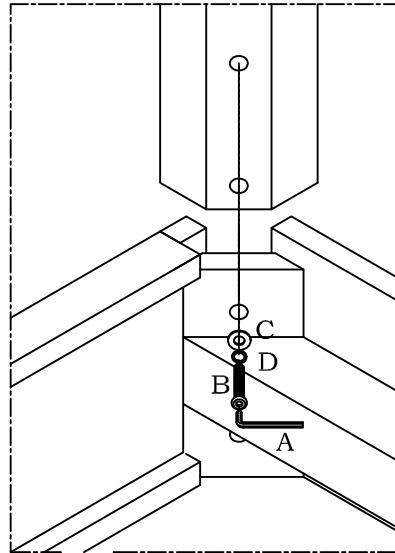







# Assembly Instruction

Item NO:BOC-485

2/2

## Hardwares

NO	Description	Sketch	Q'TY
A	Allen key	 5MM	1pc
B	2" Bolt		8pcs
C	Flat washer		8pcs
D	Spring washer		8pcs
E	Wire lid		1pc
	Touch up Pen		1pc

