

# Assembly Instruction

Item NO:BOCA

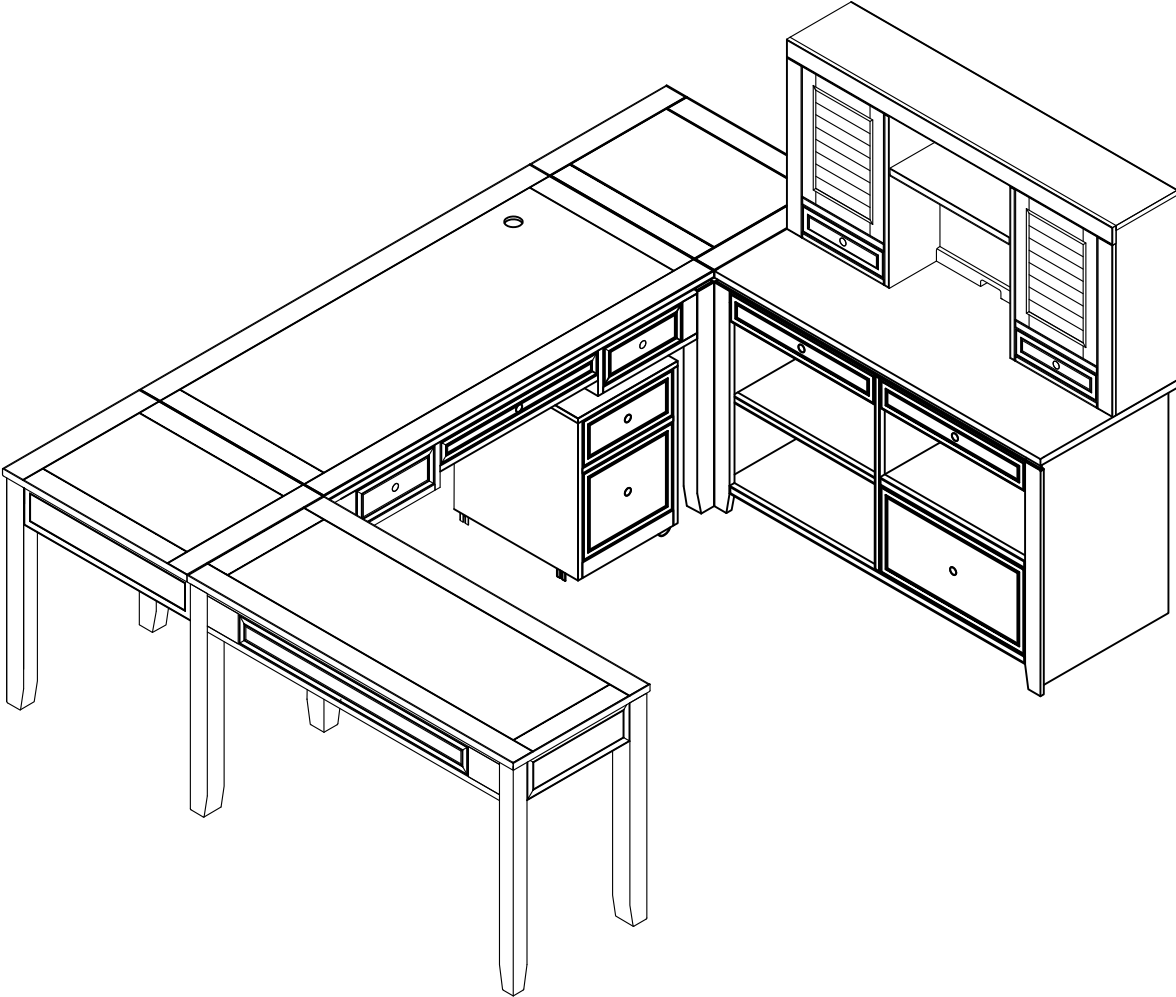







# Assembly Instruction

Item NO:BOC-357D

2/10

## Hardwares

NO	Description	Sketch	Q'TY
A	Allen key		1pc
B	2" Bolt		8pcs
C	Flat washer		8pcs
D	Spring washer		8pcs
E	Wire lid		1pc
	Touch up Pen		1pc

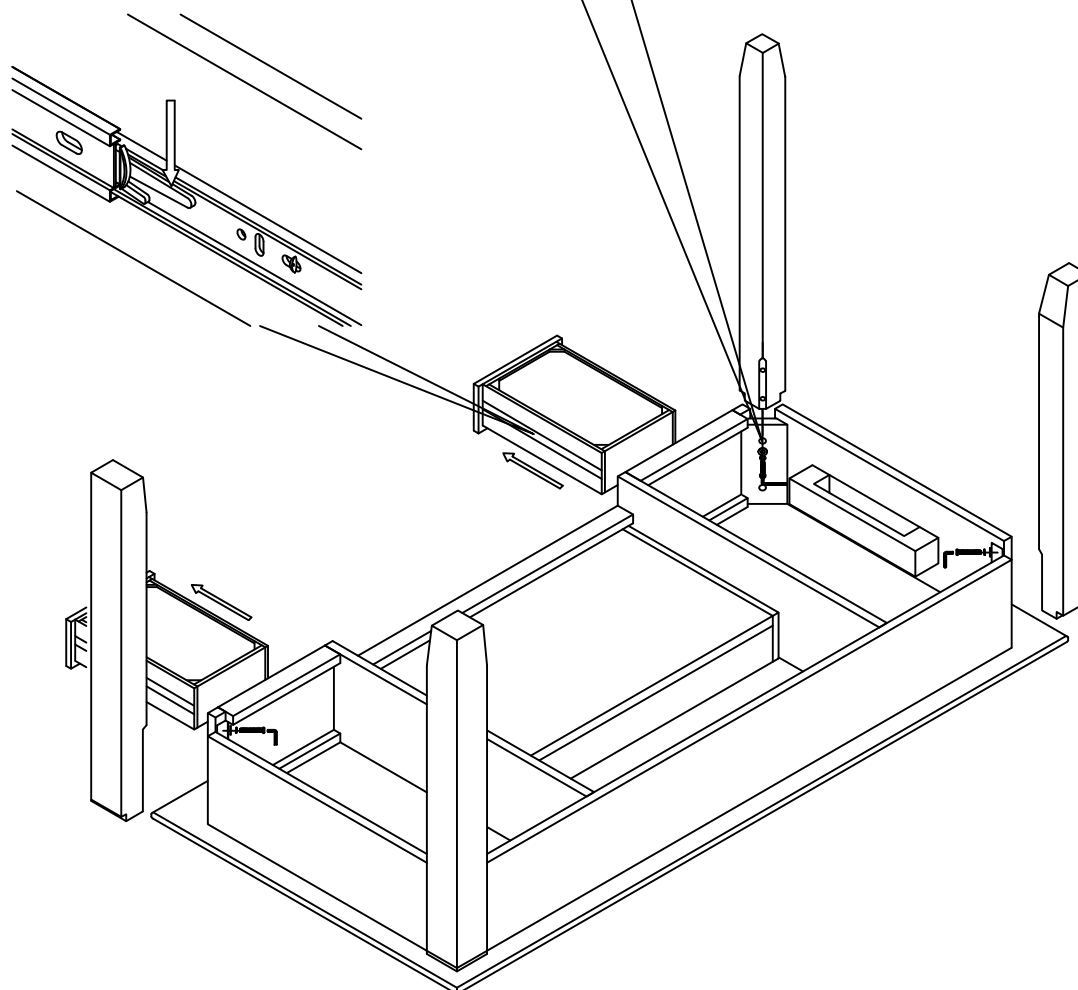
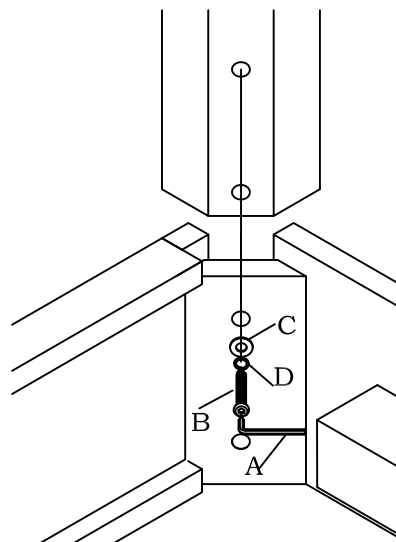







# Assembly Instruction

Item NO:BOC-357D

3/10

## Hardwares

NO	Description	Sketch	Q'TY
A	Allen key	 5MM	1pc
B	2" Bolt		8pcs
C	Flat washer		8pcs
D	Spring washer		8pcs
E	Wire lid		1pc
	Touch up Pen		1pc

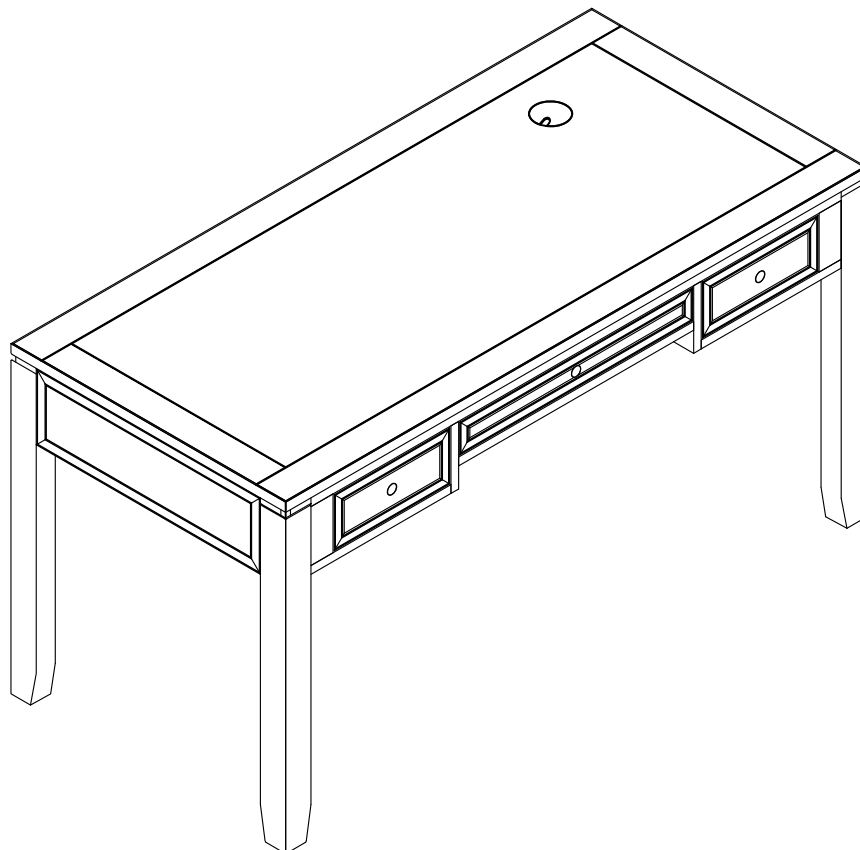
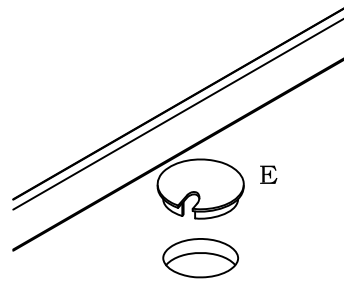





# Assembly Instruction

Item NO:BOC-347D

4/10

## Hardwares

NO	Description	Sketch	Q'TY
A	Allen key	 5MM 7	1pc
B	2" Bolt		8pcs
C	Flat washer		8pcs
D	Spring washer		8pcs
	Touch up Pen		1pc

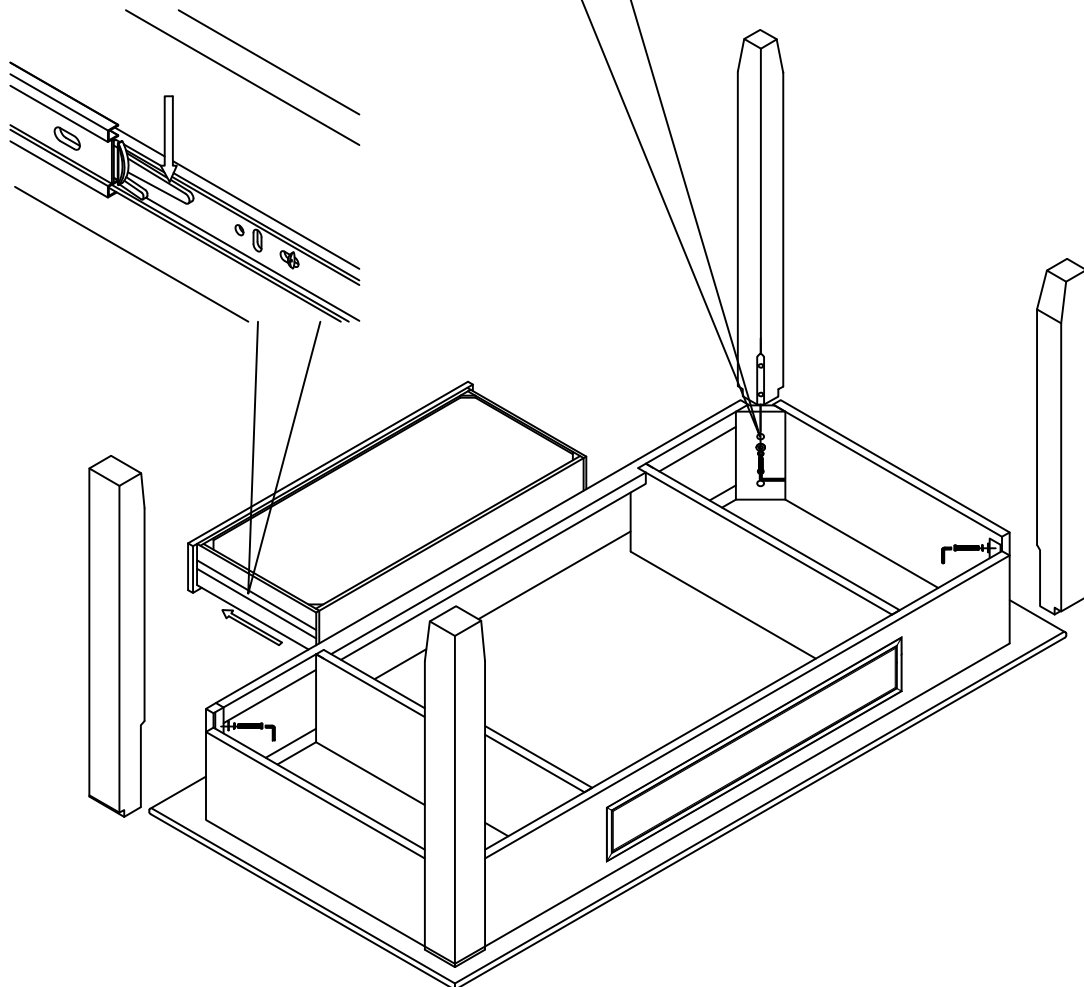
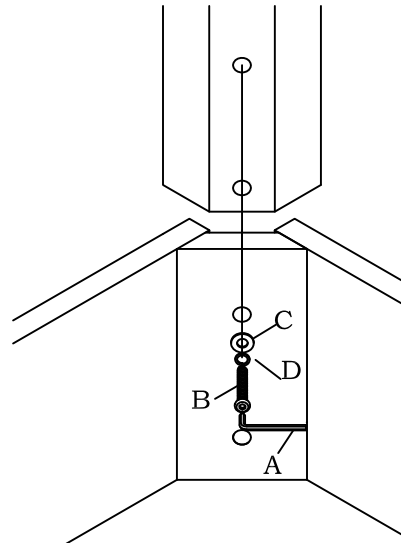

# Assembly Instruction

Item NO:BOC-347C

5/10

## Hardwares

NO	Description	Sketch	Q'TY
A	Touch up Pen		1pc

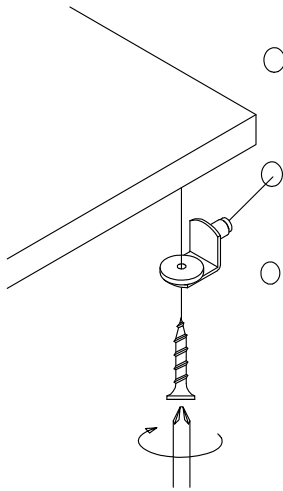

If you want to adjust the shelf, please loosen the screw.

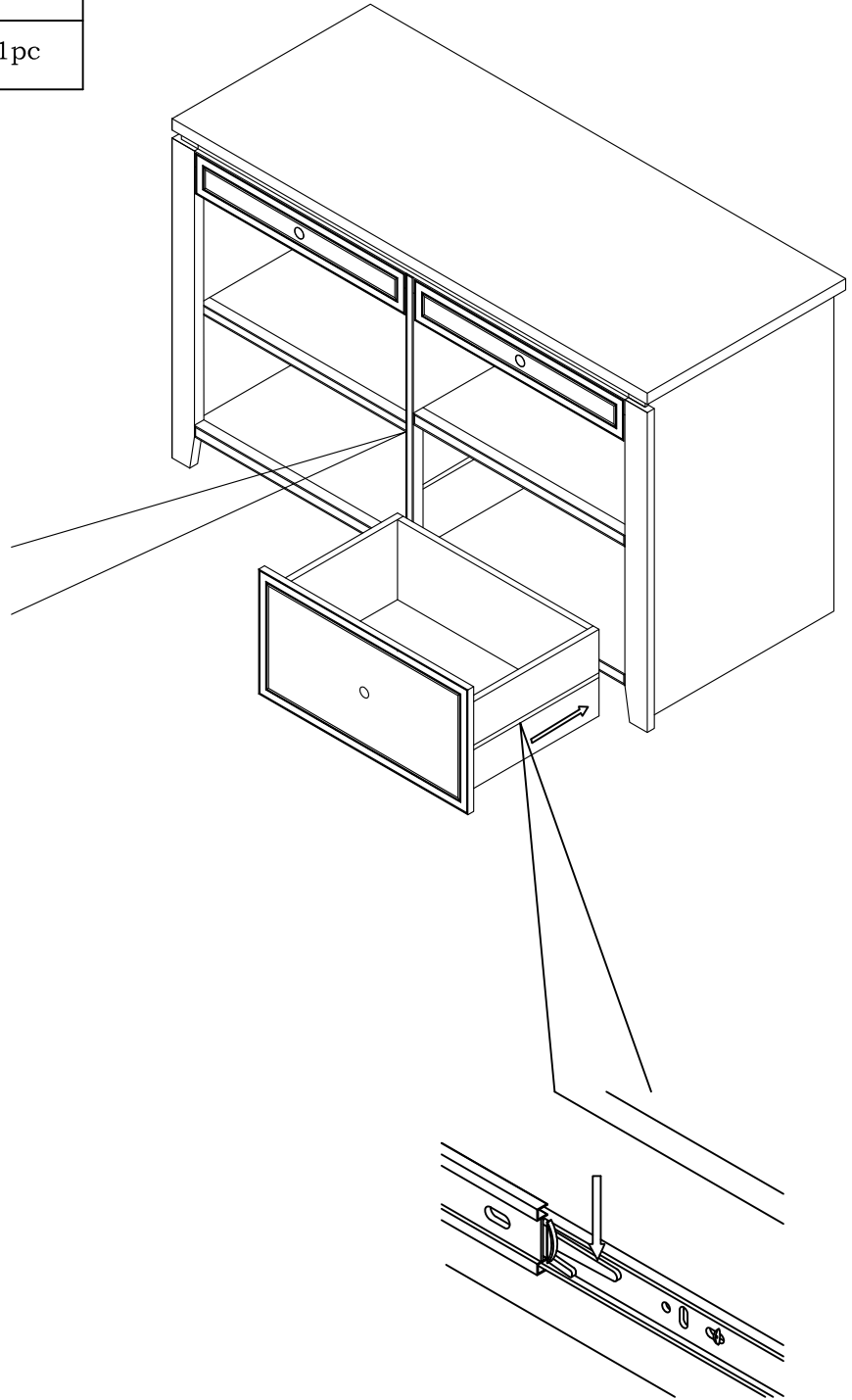

# Assembly Instruction

Item NO: BOC-347H

6/10

## Hardwares

NO	Description	Sketch	Q'TY
A	Touch up Pen		1pc

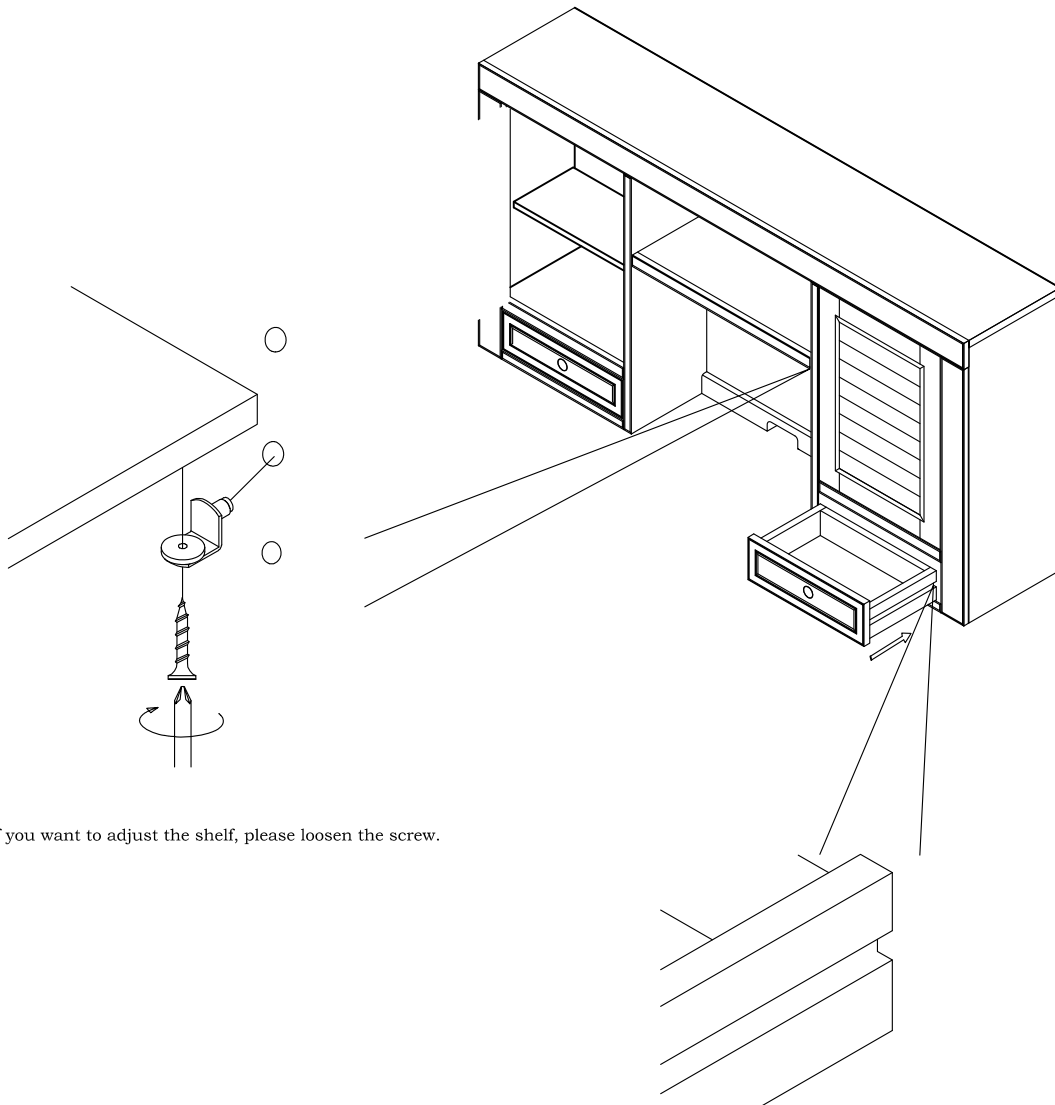

If you want to adjust the shelf, please loosen the screw.

# Assembly Instruction

Item NO:BOC-347C/347H

7/10

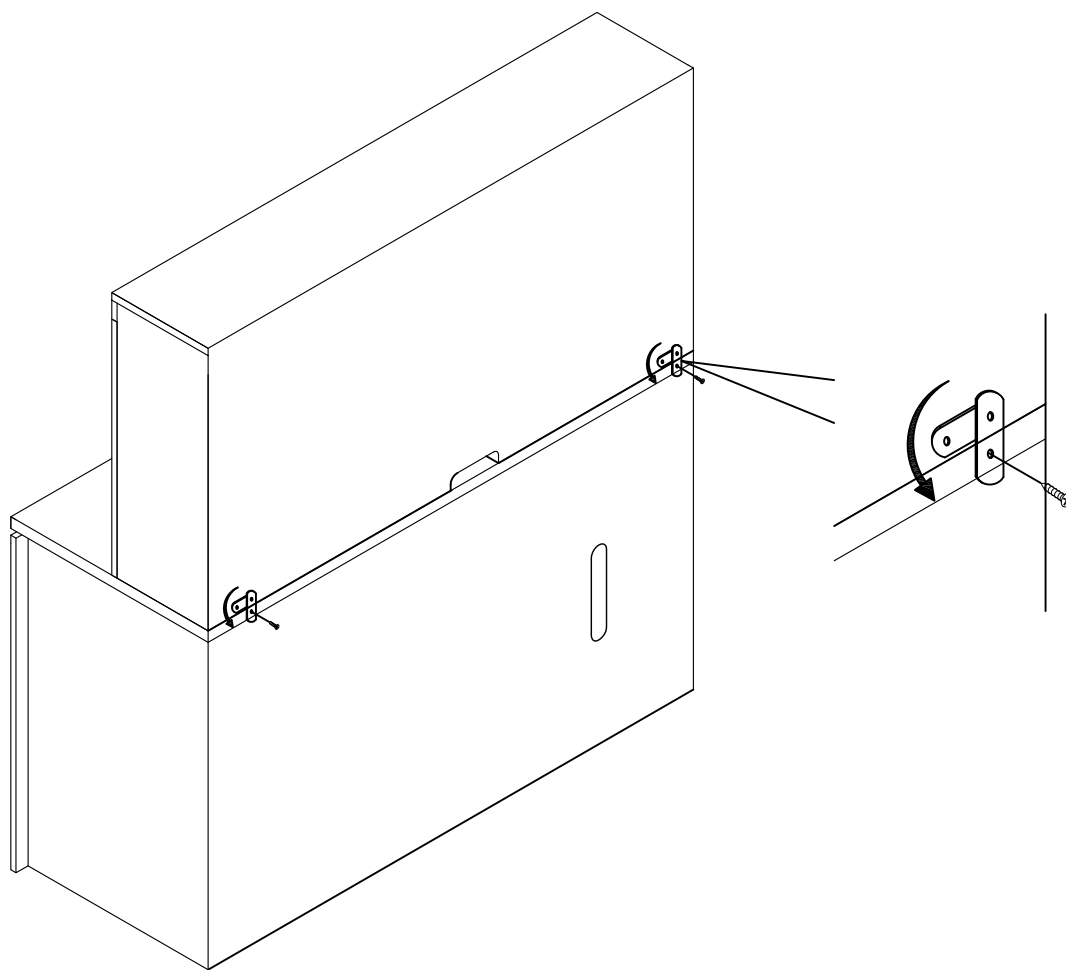













# Assembly Instruction

Item NO: BOC-370

8/10

## Hardwares

NO	Description	Sketch	Specification	Q'TY
A	Allen key		3/16"	1pc
B	Bolt		Ø5/16*2"	2pcs
C	Flat washer		Ø5/16"*3/4"	2pcs
D	Spring washer		Ø5/16"	2pcs
E	Allen key	<sup>4MM</sup> 	5/32"	1pc
F	Bolt		Ø1/4*1-1/2"	5pcs
G	Bolt		Ø1/4*3/4"	8pcs
H	Flat washer		Ø1/4*3/4"	13pcs
I	Spring washer		Ø1/4"	13pcs

NO	Description	Sketch	Q'TY
J	Long metal bracket		1pc
K	Short metal bracket		1pc
	Touch up Pen		1pc

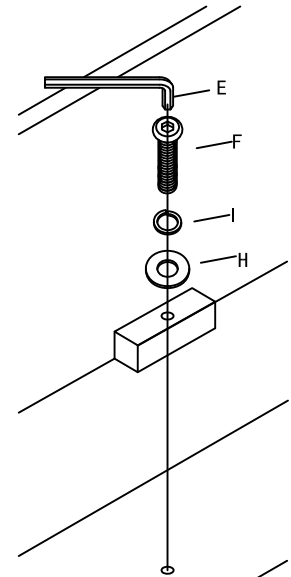

To set up a Left Corner Table, please match the "L" label on the apron to the "L" label found underneath the Corner Table's top.

To set up a Right Corner Table, please match the "R" label on the apron to the "R" label found underneath the Corner Table's top.

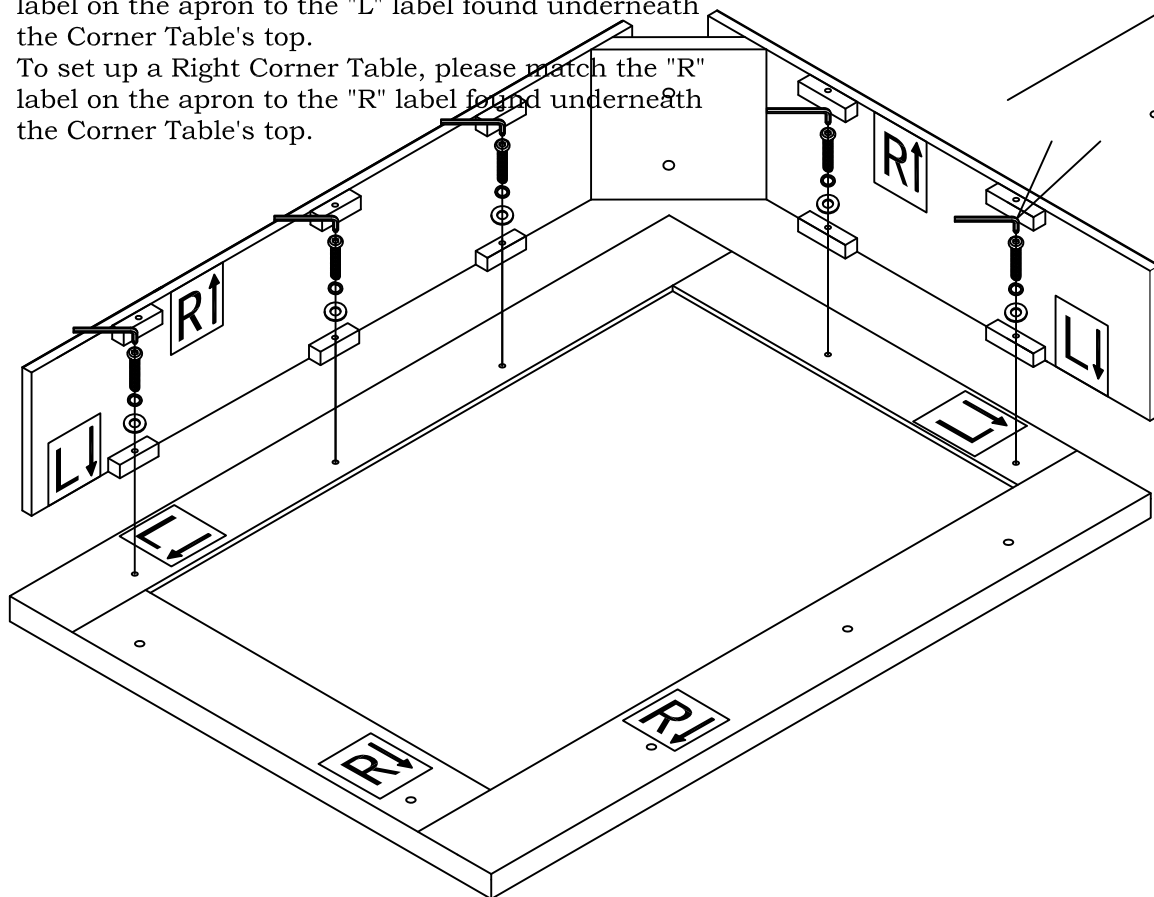















# Assembly Instruction

Item NO:BOC-370

9/10

## Hardwares

NO	Description	Sketch	Specification	Q'TY
A	Allen key		3/16"	1pc
B	Bolt		Ø5/16*2"	2pcs
C	Flat washer		Ø5/16**3/4"	2pcs
D	Spring washer		Ø5/16"	2pcs
E	Allen key	<sup>4MM</sup> 	5/32"	1pc
F	Bolt		Ø1/4*1-1/2"	5pcs
G	Bolt		Ø1/4*3/4"	8pcs
H	Flat washer		Ø1/4*3/4"	13pcs
I	Spring washer		Ø1/4"	13pcs

NO	Description	Sketch	Q'TY
J	Long metal bracket		1pc
K	Short metal bracket		1pc
	Touch up Pen		1pc

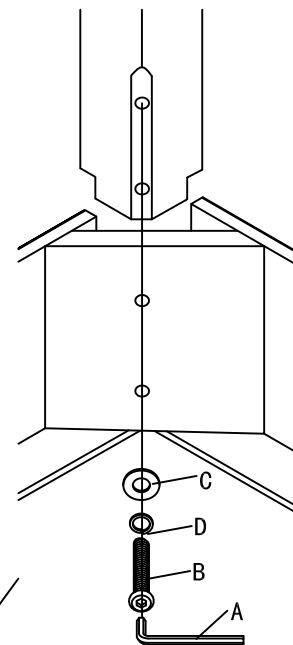
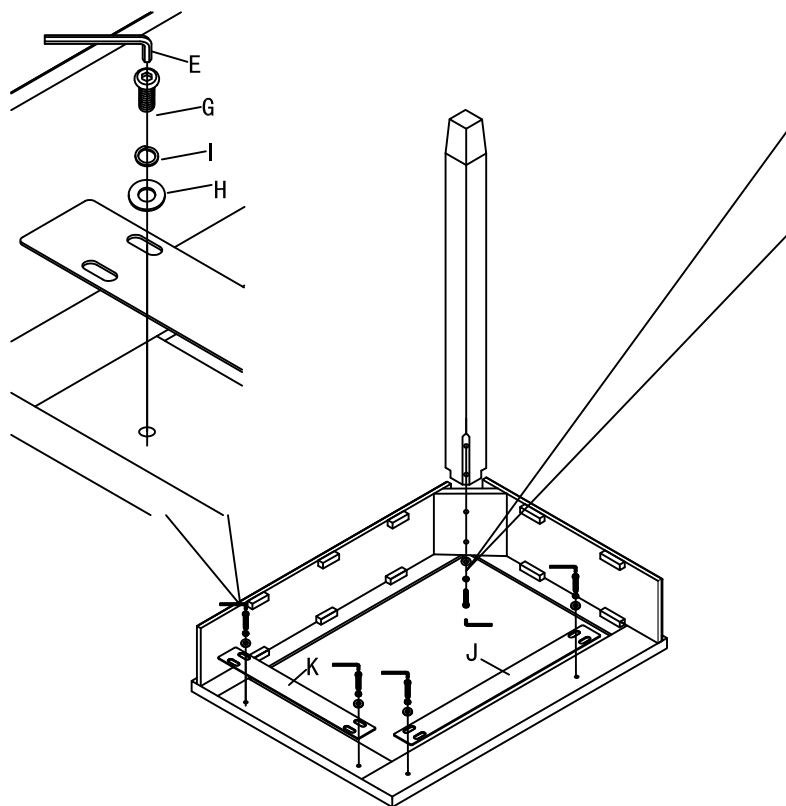

# Assembly Instruction

Item NO:BOC-370

10/10

Configuration for BOS-370, BOS-357D & BOS-347D  
assembling together.

