

# Assembly Instructions



Style: Escape

Size: Queen

Carton 1

Carton 3

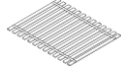



NO.	Description		QTY
A	Headboard		1

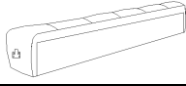

NO.	Description		QTY
B	Footboard		1
D	Slats		1 set
J	Center slat support (82.48" length)		1
K	Side rail slat support (77.95" length)		2

Carton 2

NO.	Description		QTY
C	Side rails		2

Hardware (in carton 3 box)

NO.	Description		QTY
E	Middle Support feet		6
G-1	Bolts		0.25*1" 12
G-2	Washers		0.26*0.75*0.08" 22
G-3	Wrench		0.16*1.69*2.36" 1

NO.	Description		QTY
F	Footboard corner brackets		2
H	Side rails bolts		0.24*2.76" 10
I	Screws		1.57" 8

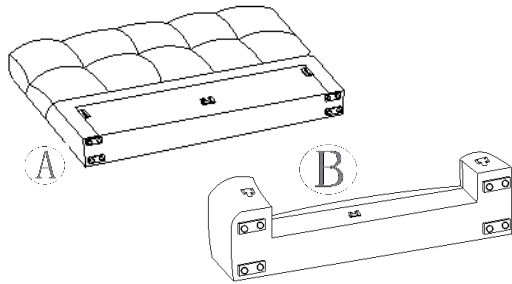

1. Feet for headboard and footboard are preinstalled.

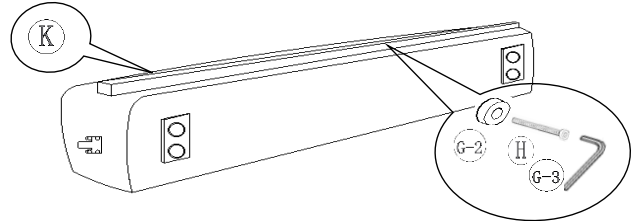

2. Feet for side rails are preinstalled. Use washers (G-2) with bolts (H) and attach slat support (K) with wrench provided (G-3). Screw and secure bolts tightly.

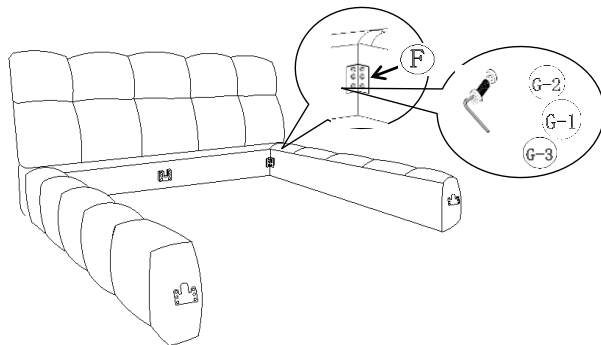

3. Secure connection of the headboard and side rails with brackets (F) and hardware provided (G-1, G-2, G-3). Place and align bracket to the predrilled holes. Insert bolts with washers and screw bolts tightly.

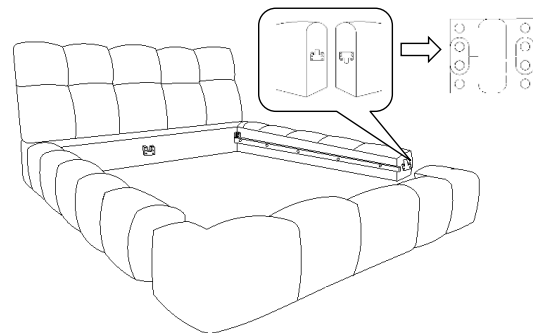

4. Metal connectors are preinstalled at the end of the side rails and footboard. Connect by sliding the two connectors together by overlaying them on top of each other.

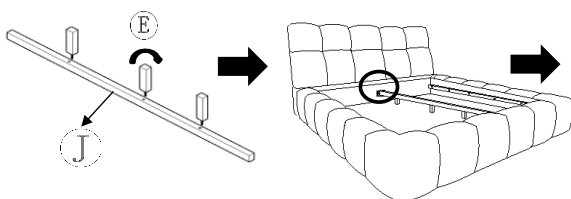

5. Screw middle support feet (E) into the predrilled holes on center slat support (J) and slide the both ends of center slat support in to the U Shape connector circled in diagram.

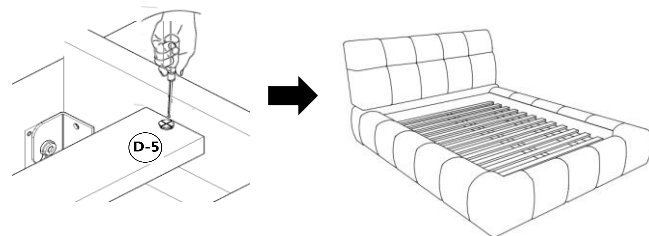

6. Open the rolled slats (D) and place on top of the slat support. Secure the slats using the screws (I).