

Headboard hardware located in velcro pouch in back of headboard.
Footboard hardware located in one end of the footboard/siderails.

ASSEMBLY INSTRUCTIONS

Item No: BAVE#8000/BAVE#9000

Description: AVERY QUEEN/KING BED

Thank you for purchasing this quality product. Be sure to check all packing material carefully for small parts that may have come loose inside the carton during shipment.



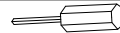

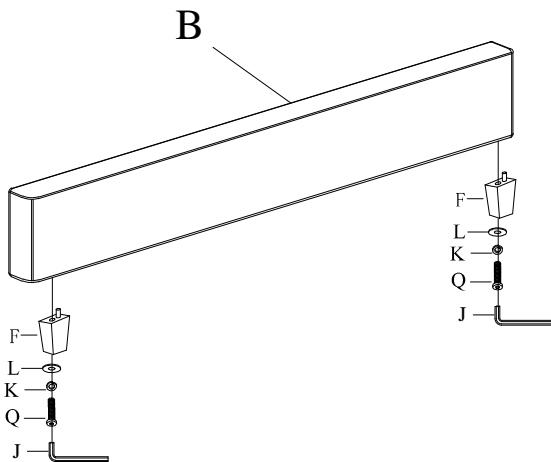
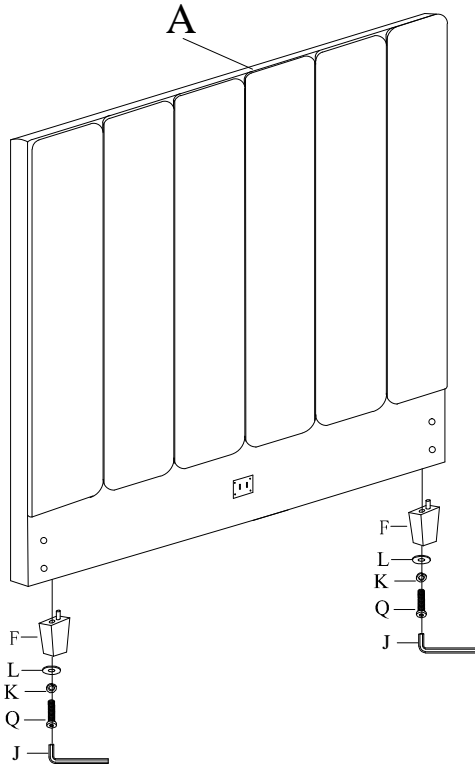

TOOLS REQUIRED(NOT PROVIDED)

 Phillips Screwdriver

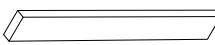



Step1: Assembly HB(A),FB(B) with Leg(F).













PARTS LIST:





No.	Description	Sketch	Quantity
A	Headboard		1PC
B	Footboard		1PC
C	Side Rail		2PCS
D	Centre Rail		1PC
E	Center Rail Support Leg	 1.2**1.2**7"	3PCS
E1	Slat Support Leg	 1.2**1.2**8"	8PCS
F	Leg	 3**3**5.5"	4PCS
G	Slats		4PCS

HB HARDWARE LIST:(2) LEGS FOR HEADBOARD

No.	Description	Sketch	Size	Quantity
F	Leg		3**3**5.5"	2PCS
J	Allen Key		M5*4"	1PCS
K	Spring Washer		Ø5/16"	2PCS
L	Flat Washer		Ø5/16"	2PCS
Q	Bolt		Ø5/16**4"	2PCS

FB HARDWARE LIST:(2) LEGS FOR FOOTBOARD

No.	Description	Sketch	Size	Quantity
H	Bolt		Ø5/16**2-1/2"	4PCS
I	Bolt		Ø5/16**1-1/2"	15PCS
J	Allen Key		M5*4"	1PCS
K	Spring Washer		Ø5/16"	10PCS
L	Flat Washer		Ø5/16"	25PCS
M	Screw		Ø8*1"	4PCS
N	Screw		Ø8*1-1/2"	8PCS
O	Spanner		M12	1PC
P	Nut		M12	4PCS
Q	Bolt		Ø5/16**4"	2PCS
R	Metal bracket		50*32*30*2	2SET

Q	Bolt		Ø5/16*4"	4PCS
K	Spring Washer		Ø5/16	4PCS
L	Flat Washer		Ø5/16	4PCS
J	Allen Key		M5	1 PC

Headboard hardware located in velcro pouch in back of headboard.
Footboard hardware located in one end of the footboard/siderails.

ASSEMBLY INSTRUCTIONS

Item No: BAVE#8000/BAVE#9000

Description: AVERY QUEEN/KING BED

Thank you for purchasing this quality product. Be sure to check all packing material carefully for small parts that may have come loose inside the carton during shipment.

Step2: Assembly Side Rail(C) with HB(A)&FB(B).

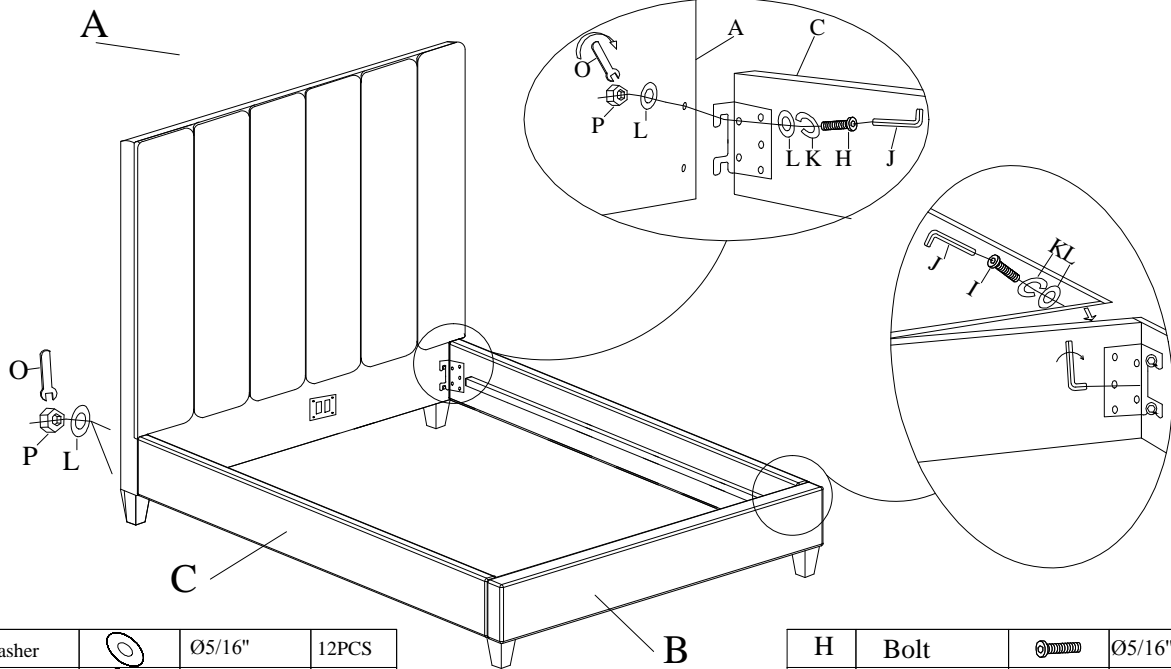

L	Flat Washer		Ø5/16"	12PCS
K	Spring Washer		Ø5/16"	8PCS
O	Spanner		M12	1PC
P	Nut		M12	4PCS

H	Bolt		Ø5/16"*2-1/2"	4PCS
I	Bolt		Ø5/16"*1-1/2"	4PCS
J	Allen Key		M5	1PC

Step3: Assembly Center Rail(D) with HB(A)&FB(B).

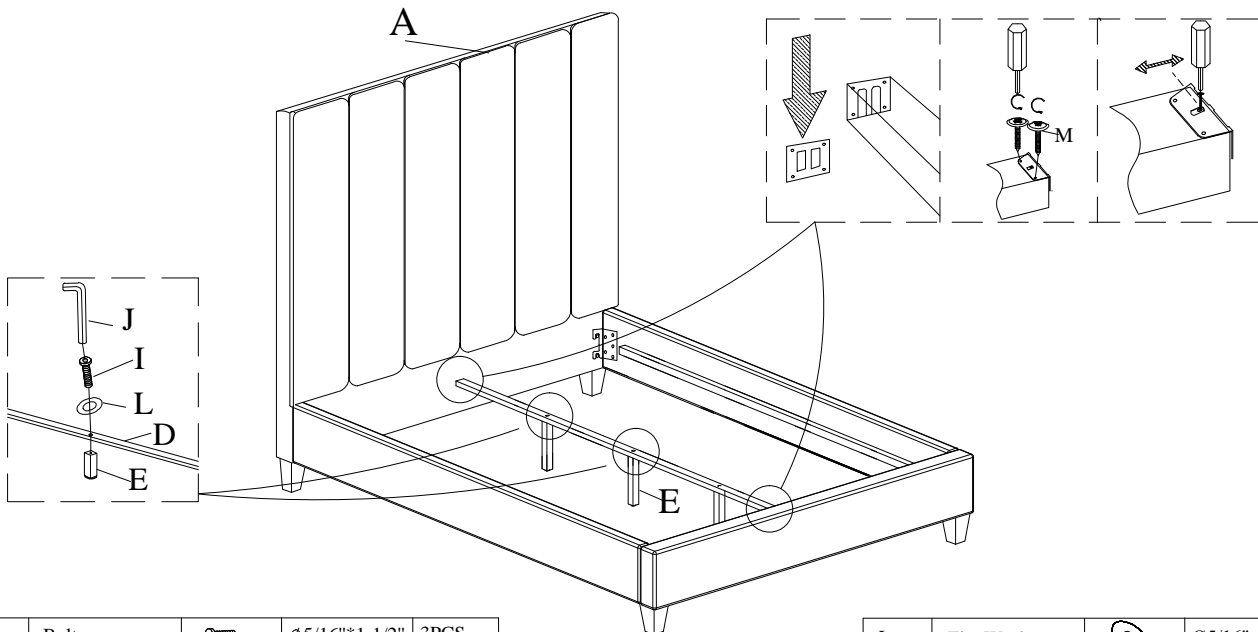

I	Bolt		Ø5/16"*1-1/2"	3PCS
J	Allen Key		M5	1PC

L	Flat Washer		Ø5/16"	3PCS
M	Screw		Ø8*1"	4PCS

Headboard hardware located in velcro pouch in back of headboard.
Footboard hardware located in one end of the footboard/siderails.

ASSEMBLY INSTRUCTIONS





Item No: BAVE#8000/BAVE#9000

Description: AVERY QUEEN/KING BED

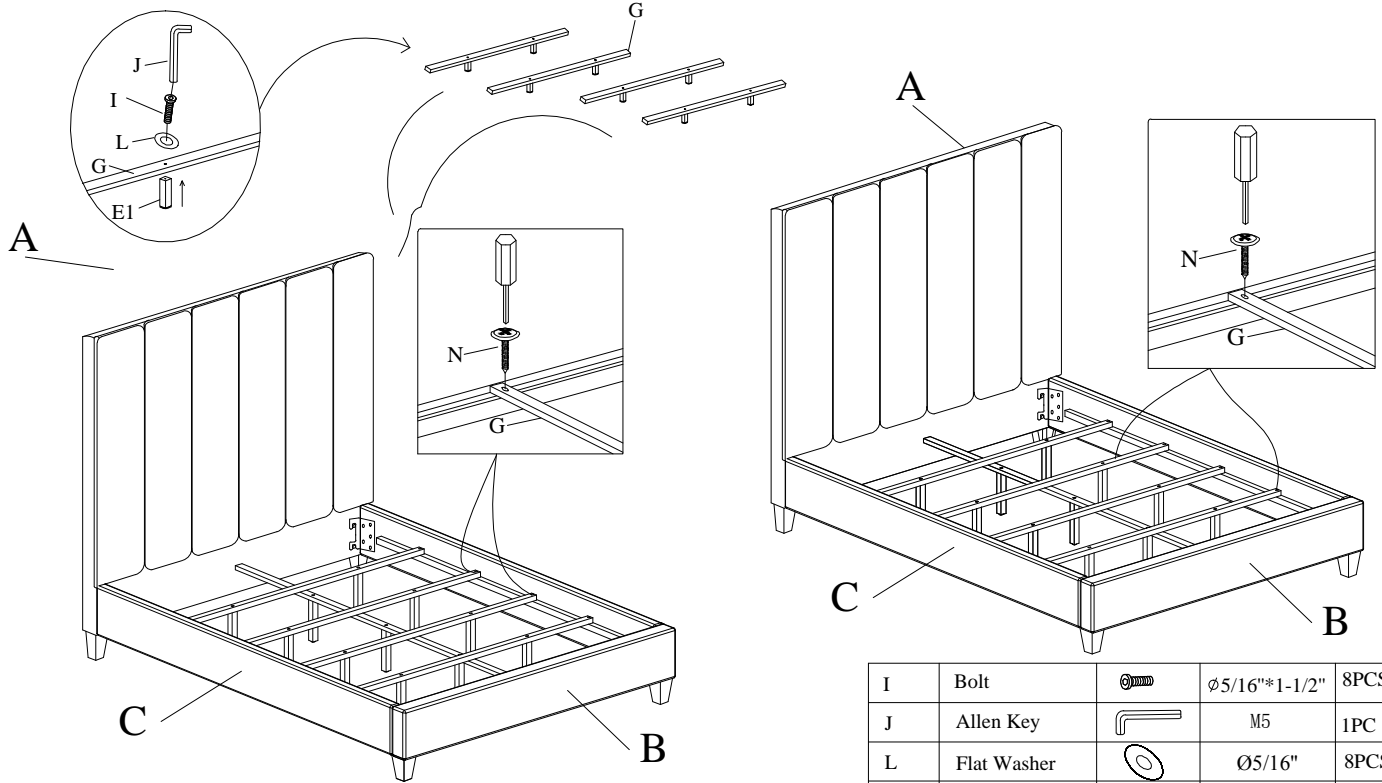
Thank you for purchasing this quality product. Be sure to check all packing material carefully for small parts that may have come loose inside the carton during shipment.

Step 4: Assembly slat(G) with side Rail(C).



I	Bolt		Ø5/16"*1-1/2"	8PCS
J	Allen Key		M5	1PC
L	Flat Washer		Ø5/16"	8PCS
N	Screw		Ø8*1-1/2"	8PCS

Step 6: Completed assembly for a regular bed.

