

ASSEMBLY INSTRUCTION

QUEEN BED

IMPORTANT SAFETY NOTICE READ CAREFULLY BEFORE BEGINNING ASSEMBLY!

- * Before you begin, please read the Assembly Instruction carefully, identify all the parts, and hardware included. Do Not skip any steps and follow the assembly steps in order.
- * Place parts on the carton while installing to prevent damage or scratches. Be sure to check all packing materials carefully for small parts may have come loose inside the carton during shipment. If parts are missing, contact the retailer from which your purchased the product to obtain any missing part. **DO NOT USE SUBSTITUTE PART.**
- * Some steps may require two or more people, do not attempt by yourself as there is a risk injury.

NOTE: GLORY FURNITURE DISCLAIMS ANY LIABILITY FOR DAMAGES OR INJURIES WHICH MAY OCCUR DUE TO FAILURE TO PROPERLY FOLLOW ASSEMBLY INSTRUCTION, FAILURE TO PROPER ASSEMBLY OR FAILURE TO PROPERLY USE OF THE PRODUCT.

NOTE: YOUR UNIT MAY LOOK DIFFERENT IN APPEARANCE FROM THE ONE SHOWN IN THE ILLUSTRATIONS ON THE INSTRUCTION SHEET.

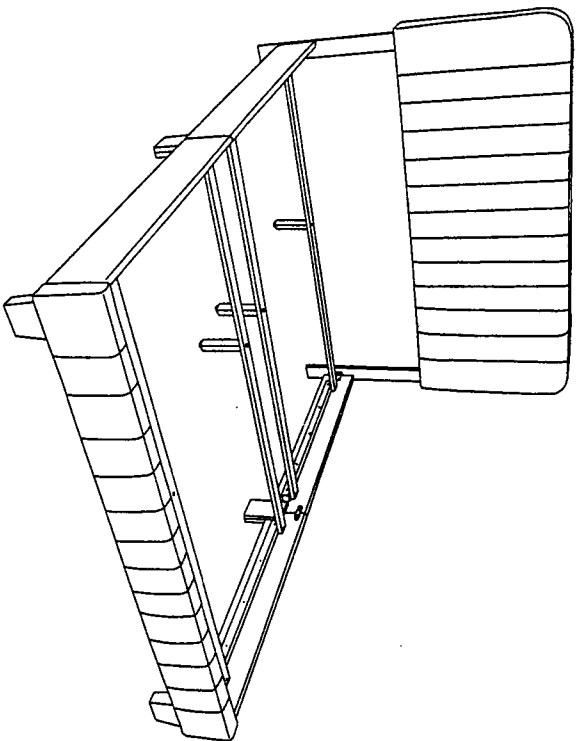

Required Tools : Screwdriver

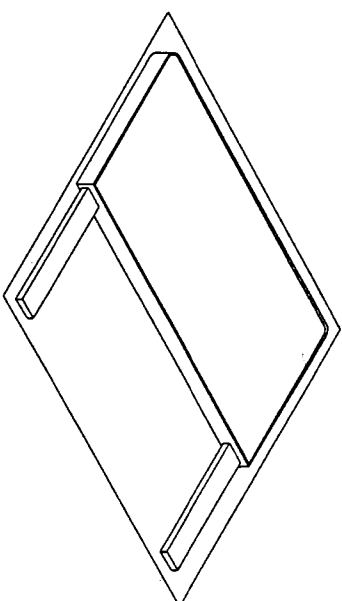
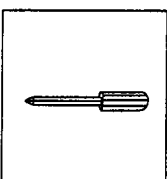





Please place on the carton while installing to prevent damage or scratches.

STOP

ASSEMBLY INSTRUCTION

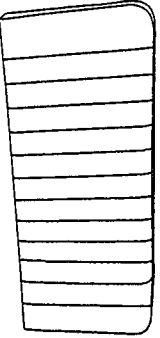
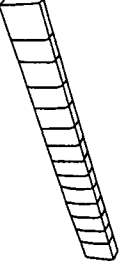
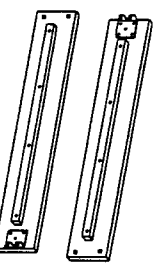
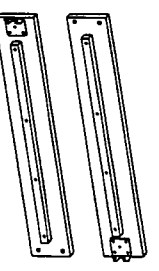
QUEEN BED



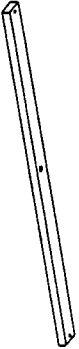
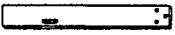
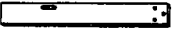
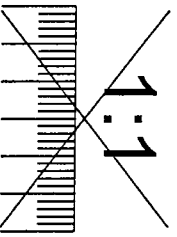



ASSEMBLY PART

<p>1.</p> 	<p>Headboard Panel</p>	<p>1 Pc</p>
<p>2.</p> 	<p>Footboard Panel</p>	<p>1 Pc</p>
<p>3.</p> 	<p>Side Rail Right</p>	<p>2 Pcs</p>
<p>4.</p> 	<p>Side Rail Left</p>	<p>2 Pcs</p>
<p>5.</p> 	<p>Support Leg</p>	<p>4 Pcs</p>
<p>6.</p> 	<p>Footboard Leg</p>	<p>2 Pcs</p>
<p>7.</p> 	<p>Side Rail Leg</p>	<p>2 Pcs</p>
<p>8.</p> 	<p>Slats</p>	<p>4 Pcs</p>
<p>9.</p> 	<p>Headboard Left Leg</p>	<p>1 Pc</p>
<p>10.</p> 	<p>Headboard Right Leg</p>	<p>1 Pc</p>
<p style="text-align: center;">1:1</p> 		

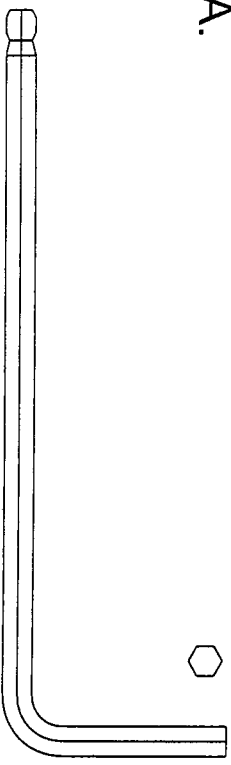
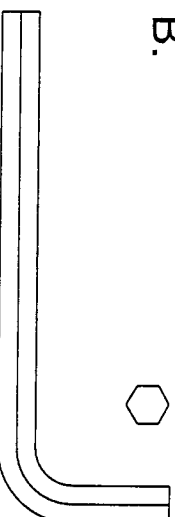
ASSEMBLY INSTRUCTION

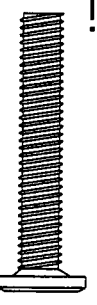
QUEEN BED

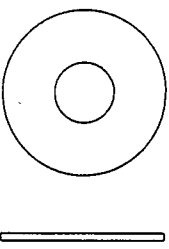
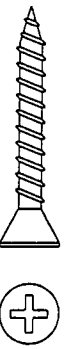
HARDWARE DESCRIPTION

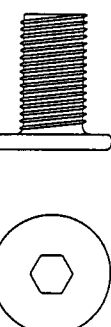
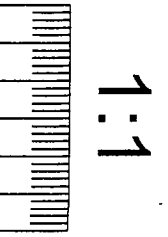
<p>A.</p> 	<p>B.</p> 	<p>C.</p> 
<p>Allen Key M4</p>	<p>Allen Key M5</p>	<p>Side Rail Connect</p>
<p>1 PC</p>	<p>1 PC</p>	<p>2PCS</p>
<p>D.</p> 	<p>E.</p> 	<p>F.</p> 
<p>JCBC Bolt M6 x 15mm</p>	<p>JCBC Bolt M6 x 35mm</p>	<p>JCBC Bolt M6 x 40mm</p>
<p>4PCS</p>	<p>8PCS</p>	<p>6PCS</p>
<p>G.</p> 	<p>Spring Washer M6</p>	
<p>14PCS</p>	<p>14PCS</p>	
<p>H.</p> 	<p>I.</p> 	<p>J.</p> 
<p>Flat Washer M8</p>	<p>CBS Screw M4 x 32mm</p>	<p>JCCA Bolt M6 x 50mm</p>
<p>10PCS</p>	<p>8PCS</p>	<p>4PCS</p>
<p>K.</p> 	<p>1:1</p> 	
<p>JCBB Bolt M8 x 16mm</p>	<p>8PCS</p>	
<p>8PCS</p>	<p>8PCS</p>	

ASSEMBLY INSTRUCTION

QUEEN BED

STEP 1.

Attach the Headboard Right Leg (10) and Headboard Left Leg (9) use JCBC Bolt (F), Spring Washer (G), Flat Washer (H) and Allen Key (A) to fix.

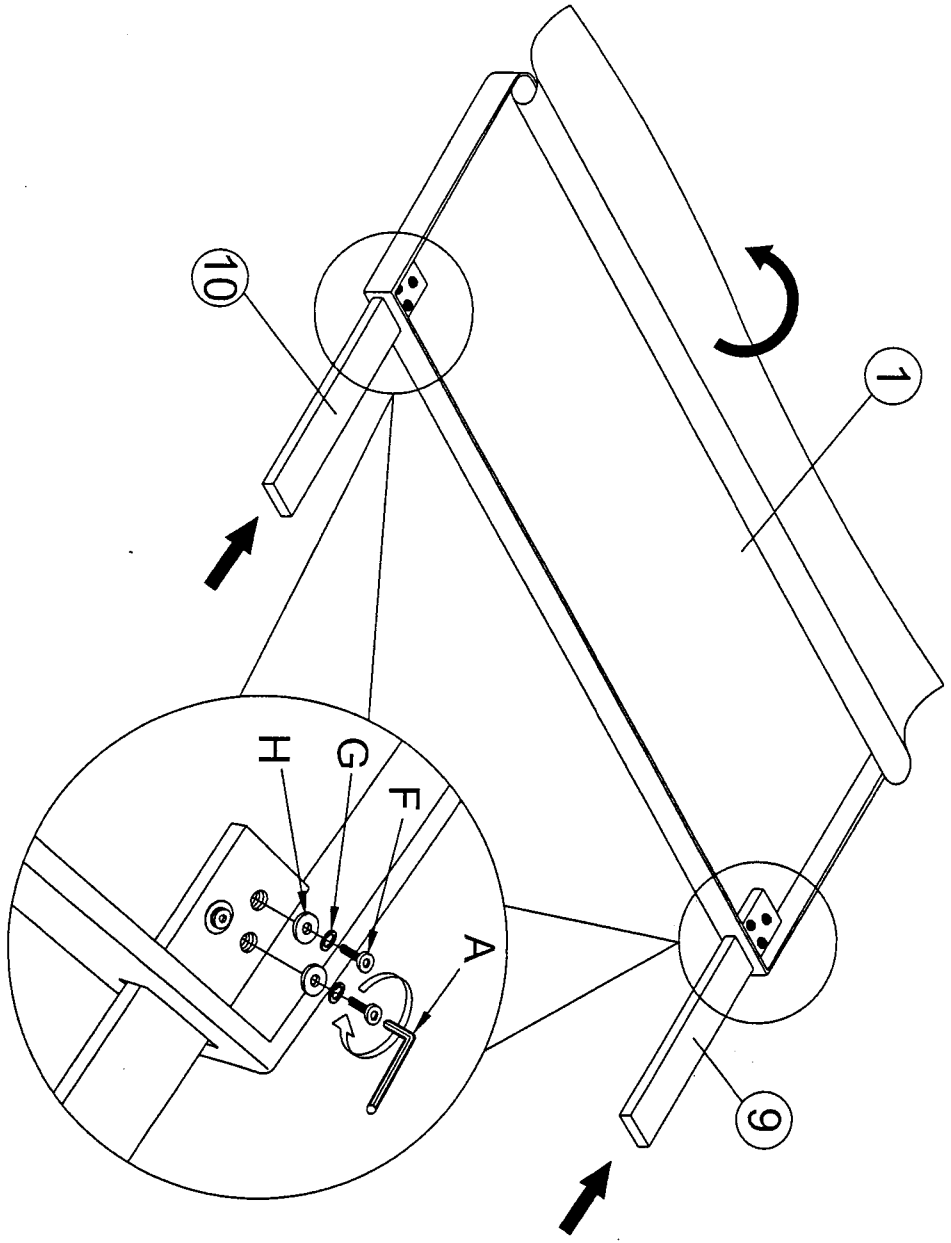

H - Flat Washer M8 - 6pcs	
G - Spring Washer M6 - 6pcs	
F - JCBC Bolt M6 x 40mm - 6pcs	
A - Allen Key M4 - 1pc	

ASSEMBLY INSTRUCTION

QUEEN BED

STEP 2.

Attached the Footboard Leg (6)(2pcs) to Footboard Panel (2). Use JCAA Bolt (J) and Allen Key (A) to fix.

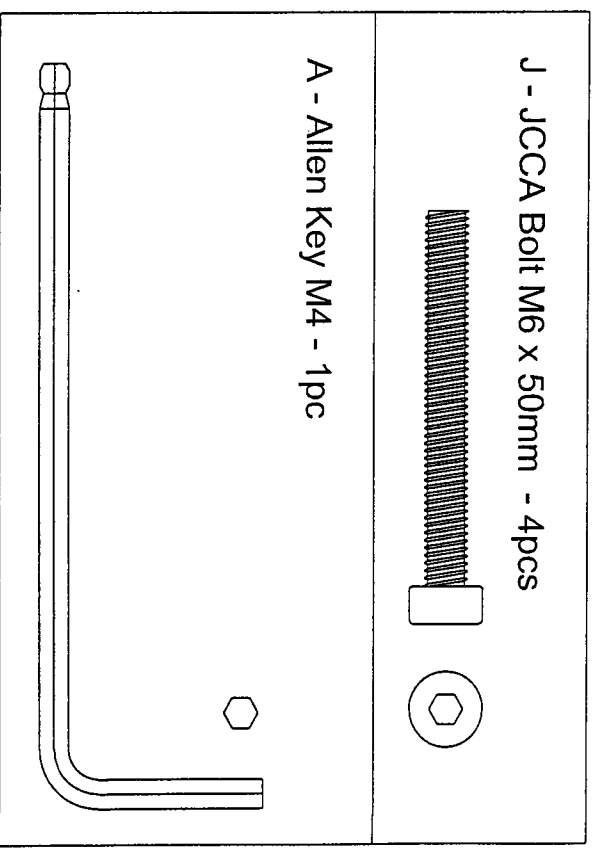
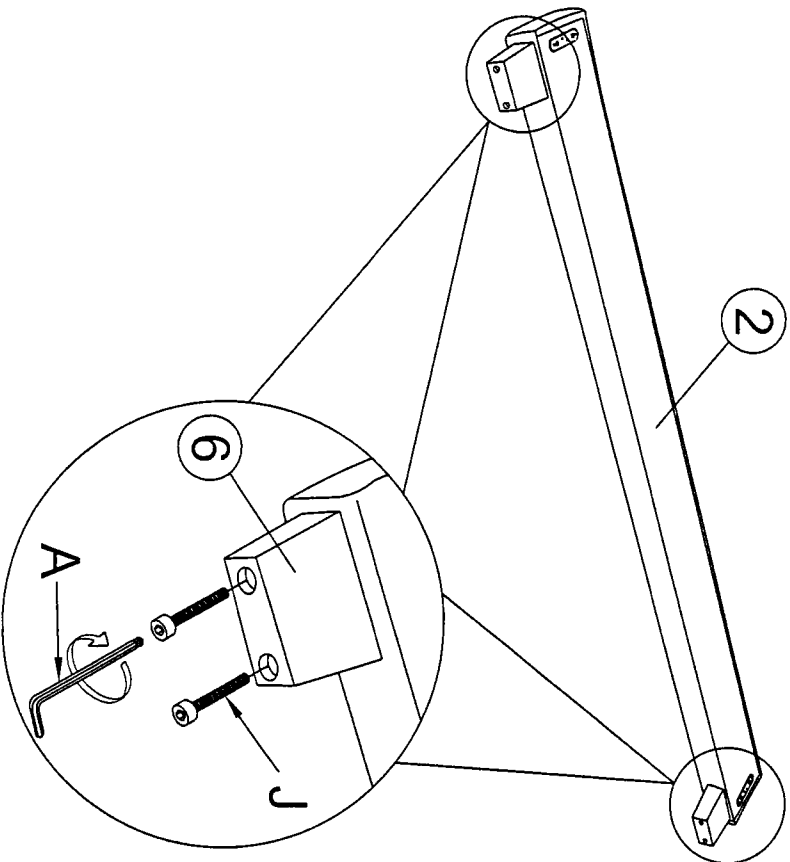

STEP 3.

Attach the Slats (8) to Support Leg (5). Use JCBC Bolt (E) and Allen Key (A) to fix.

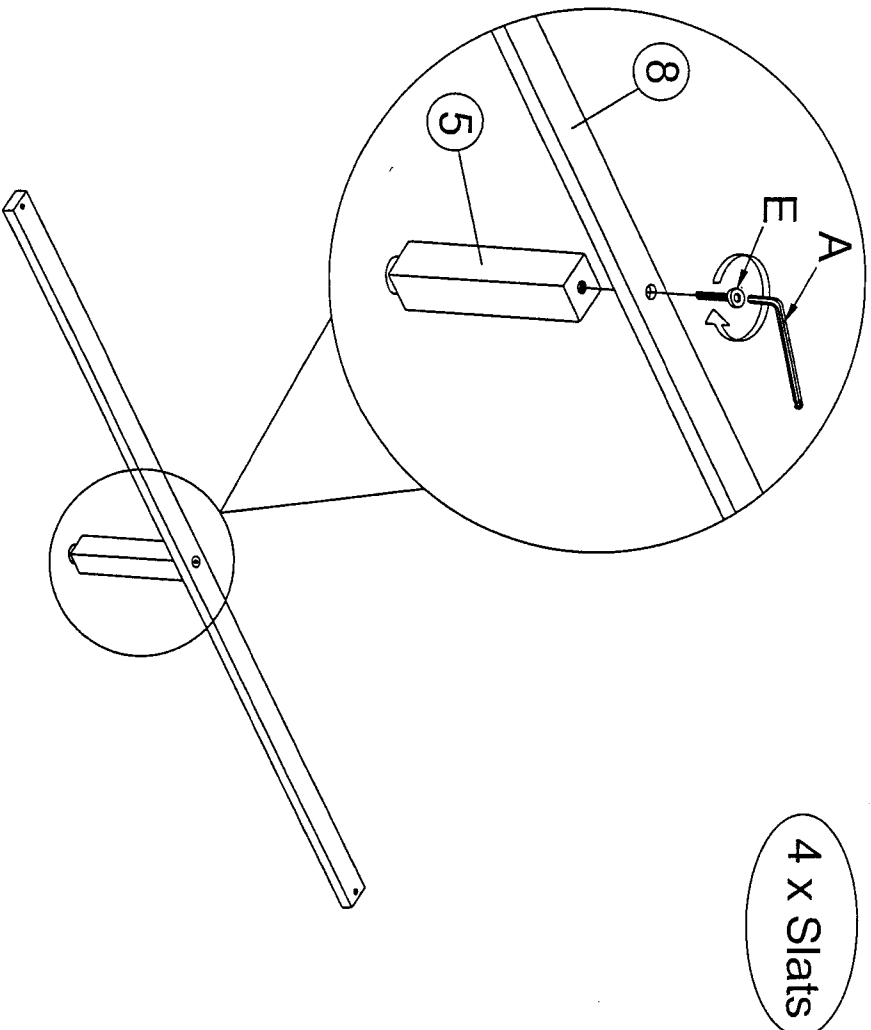

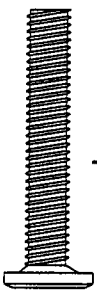
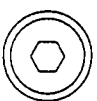
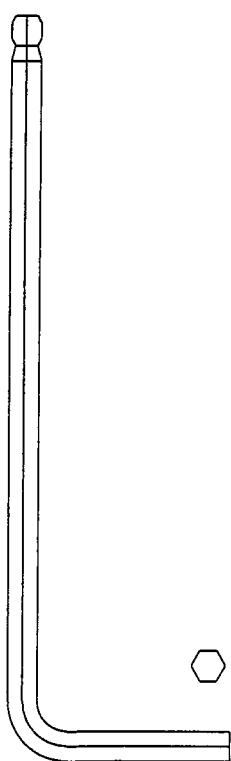

<p>E - JCBC Bolt M6 x 35mm - 4pcs</p>  	<p>A - Allen Key M4 - 1pc</p> 
---	---

STEP 4.

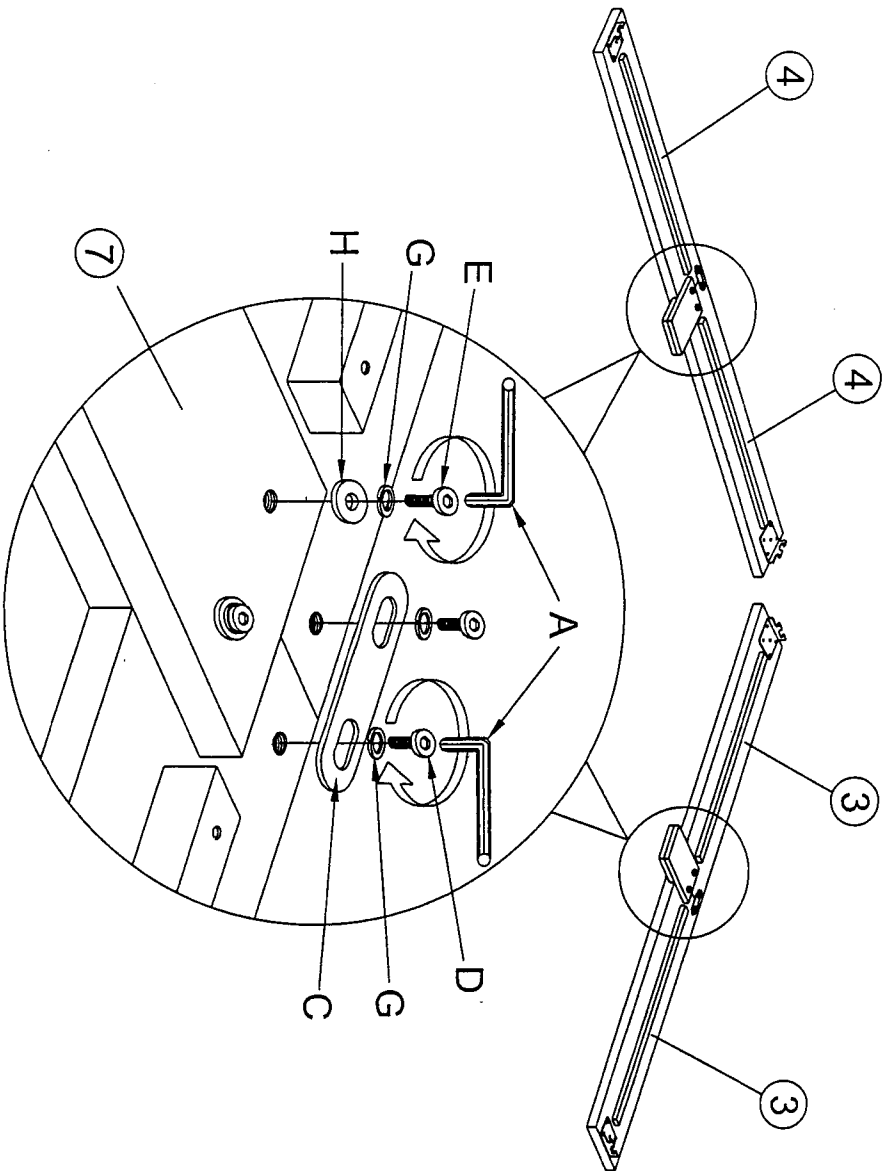
Attach and tighten the Side Rail Right (3) (2pcs) & Side Rail Left (4) (2pcs) to Side Rail Leg (7) (2pcs). Use JCBC Bolt (E), Spring Washer (G), Flat Washer (H), JCBC Bolt (D), Spring Washer (G), Side Rail Connect (C) and Allen Key (A) to fix.

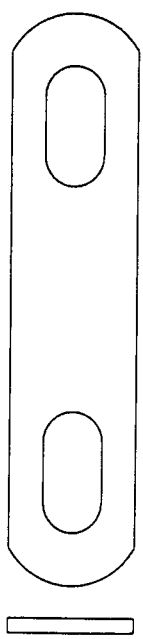
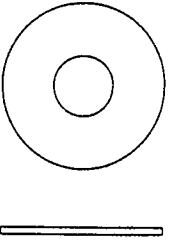

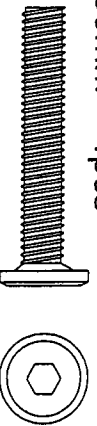
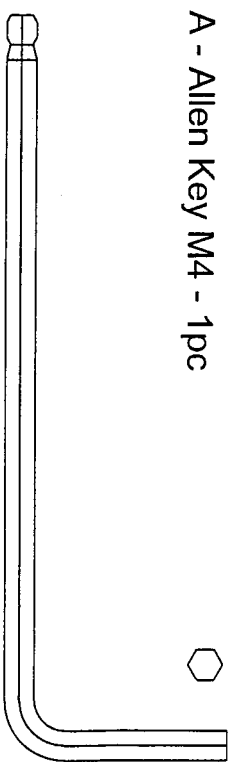
<p>C - Side Rail Connect - 2pcs</p> 
<p>H - Flat Washer M8 - 4pcs</p> 
<p>G - Spring Washer M6 - 8pcs</p> 
<p>D - JCBC Bolt M6 x 15mm - 4pcs</p> 
<p>E - JCBC Bolt M6 x 35mm - 4pcs</p> 
<p>A - Allen Key M4 - 1pc</p> 

ASSEMBLY INSTRUCTION

QUEEN BED

STEP 5.

Attach (hook) the Side Rail to Headboard Leg (1) and Footboard Panel (2).
Use JCBB Bolt (K) and Allen Key (B) to fix.

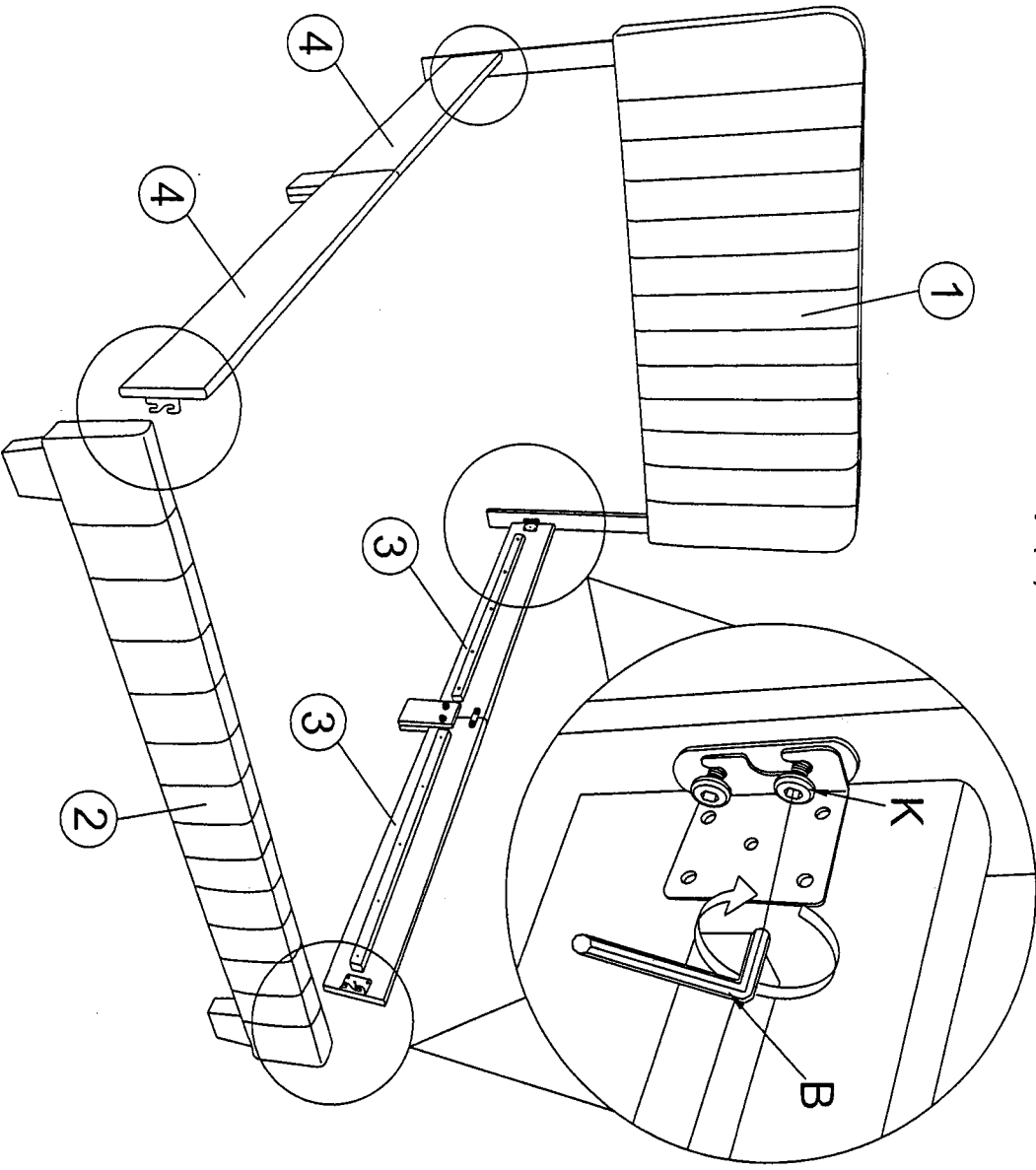

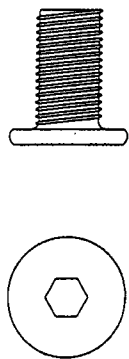
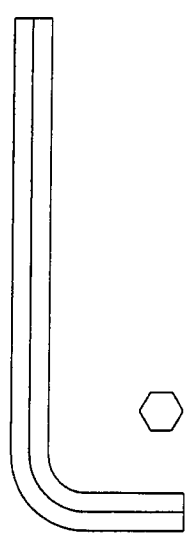
K - JCBB Bolt M8 x 16mm - 8pcs	
B - Allen Key M5 - 1pc	

STEP 6.

Attach and tighten the Slats (8) to Side Rail. Adjusting the leg adjuster to the floor. Use screw M4 x 32mm (1) and screwdriver to fix.

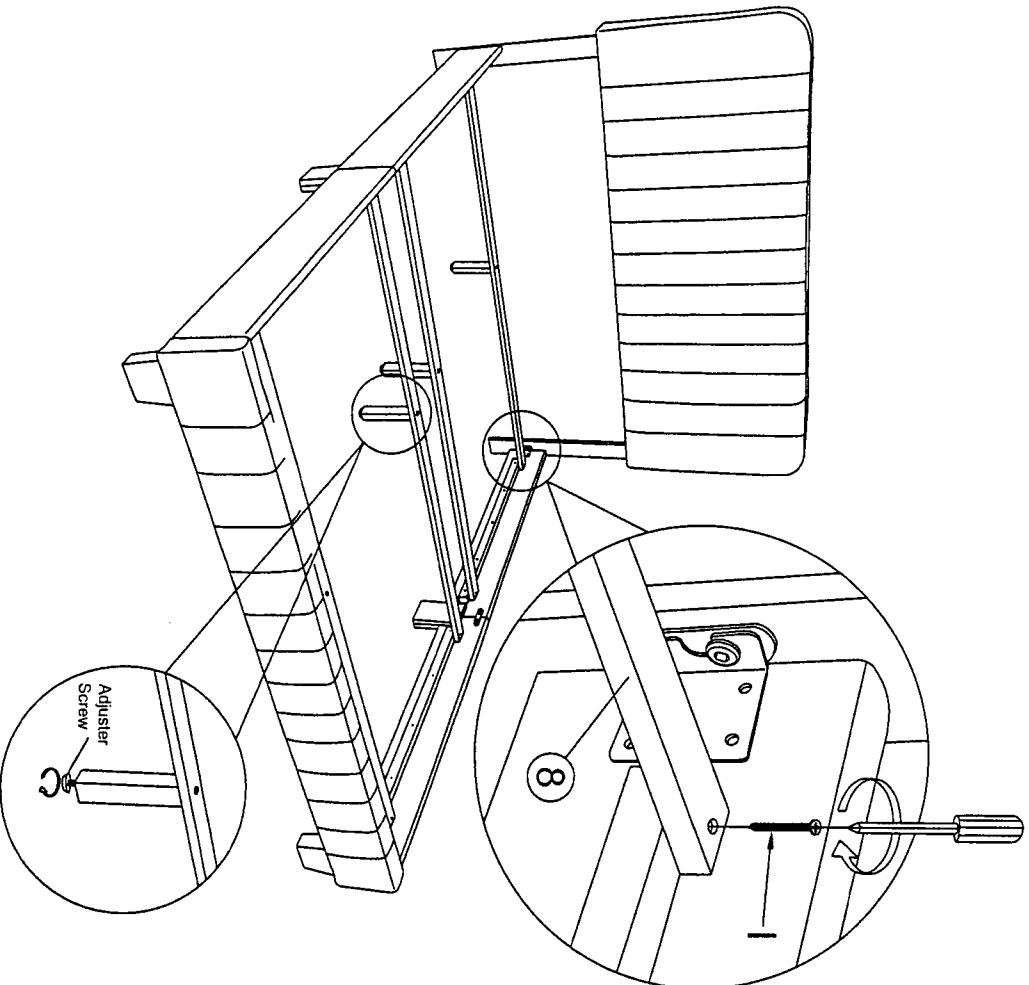

1 - CBS Screw M4 x 32mm - 8pcs

