

ASSEMBLY INSTRUCTIONS
for Full Bed Conversion Kit
BRIELLA 4 IN 1 CONVERTIBLE CRIB
Model #12688

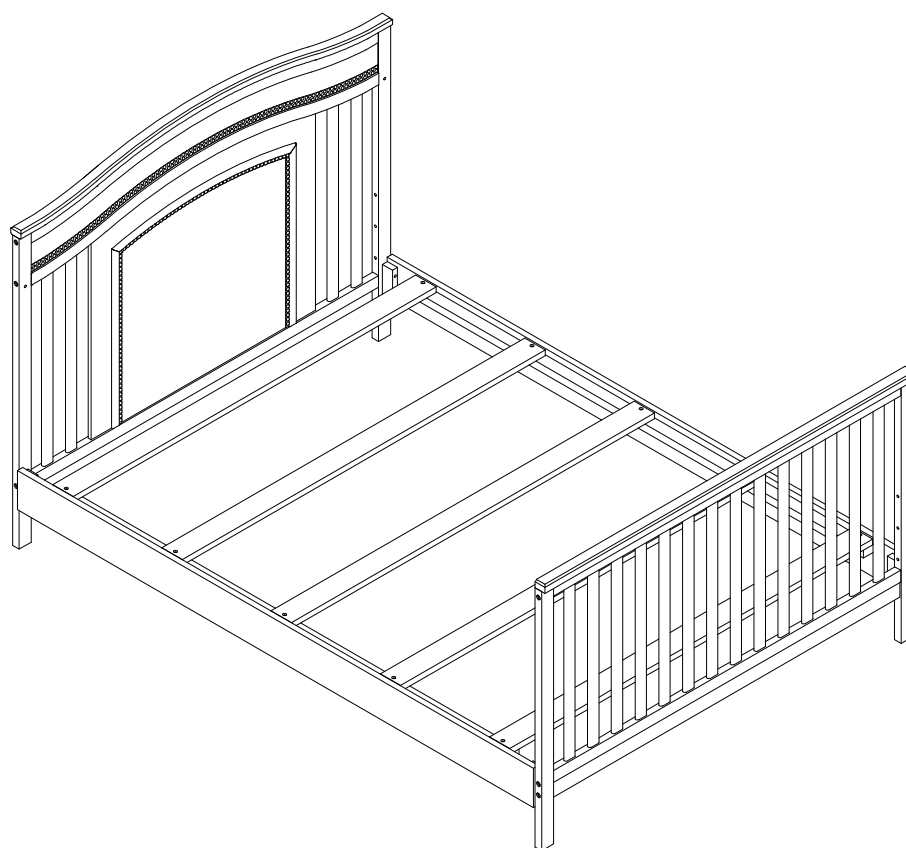

"RECOMMENDATION: We recommend the use of a Bunkie Board or box spring under a mattress for this conversion kit.

Thank you for your purchase!

Remove all parts and hardware from the box and lay on a carpeted or scratch -free work surface.
 Do not dispose of any contents until assembly is completed.
 Familiarize yourself with all exhibits and diagrams to facilitate the assembly of your crib.

TOOLS REQUIRED:

ALLEN KEY (Included)



SCREW DRIVER (Not Included)

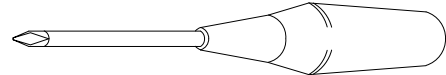

PARTS ENCLOSED IN CARTON

A. Rail (2 pcs)



B. Slat (5 pcs)

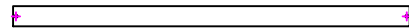

HARDWARE

(C) AllenBolt 3/4"(20 mm) (2 pcs)

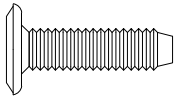

(D) Screw 1 1/4"(32 mm) (10 pcs)

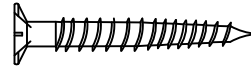

(E) Nut 3/4" (20mm) (2 pcs)

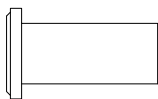

(F) Allen key (2 pcs) (length may vary)



(G) Allenbolt 2-1/16"(53 mm) (8 pcs)

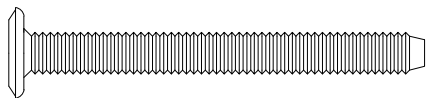

(H) Spring washer (8 pcs)



Do not fully tighten all bolts until all parts are in place.
 (please add an extra 1/2 revolution to the bolts when using spring washer after tightening)

STEP 1 " ASSEMBLY OF HEADBOARD AND FOOTBOARD"

THIS STEP REQUIRES :

- Head Board (1 pc)
- Foot Board (1 pc)
- A. Rail (2 pcs)

(F) Allen key (2 pcs)



(G) Allenbolt 2-1/16"(53 mm) (8 pcs)

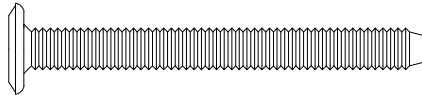

(H) Spring washer (8 pcs)

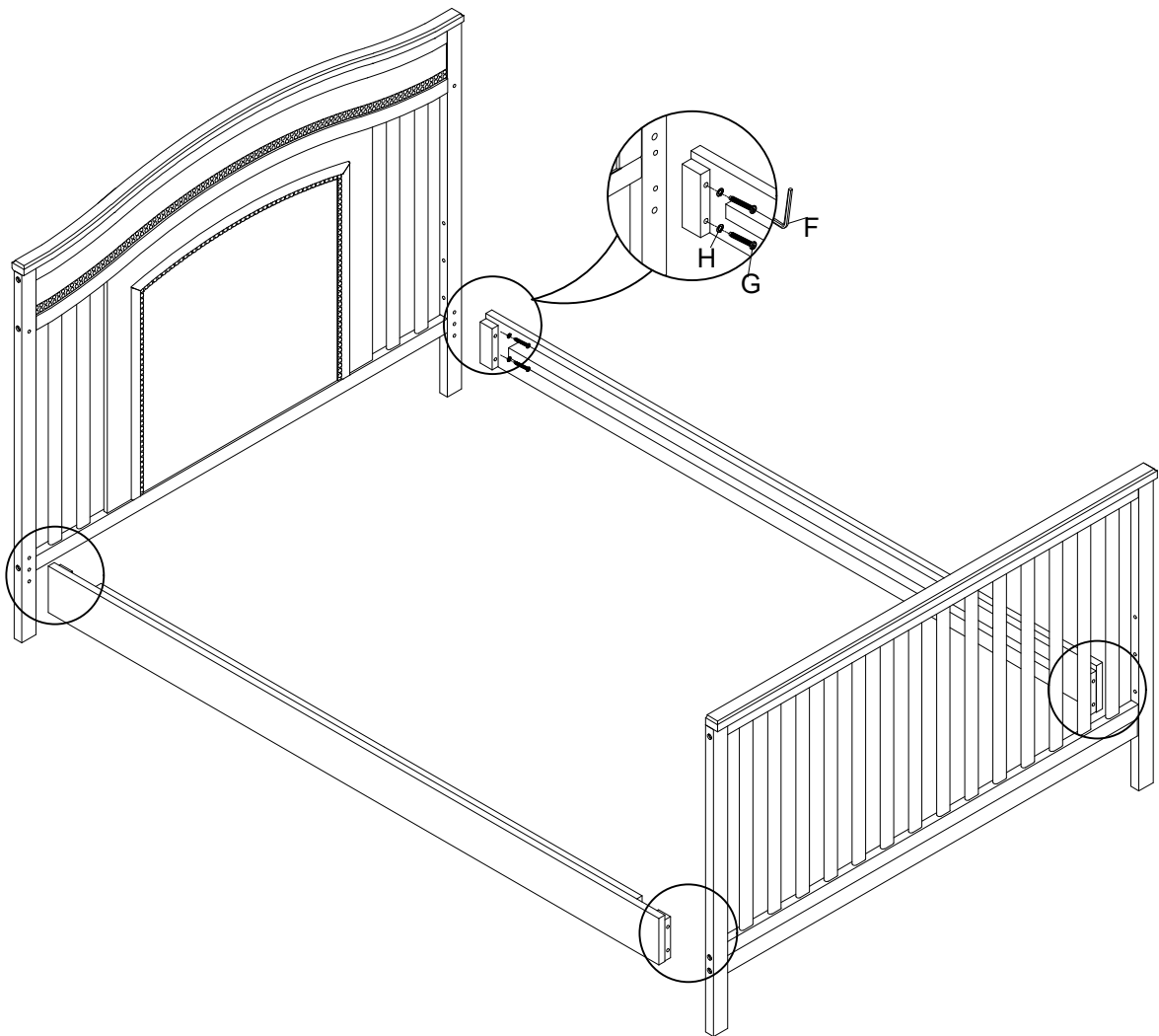

STEP 1.

Assembly Headboard and Footboard with Side rail by using Allen bolt (G) and Spring washer (H). Tighten all bolts by Allen Key (F).

STEP 2 " ASSEMBLY OF SLATS"

THIS STEP REQUIRES :

B. Slat (5 pcs)

(F) Allen key (2 pcs)

SCREW DRIVER (Not Included)

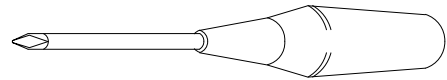

(C) AllenBolt 3/4" (20 mm) (2 pcs)

(D) Screw 1 1/4"(32 mm) (10 pcs)

(E) Nut 3/4" (20mm) (2 pcs)

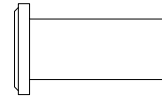
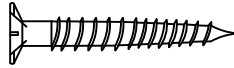
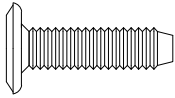

STEP 3

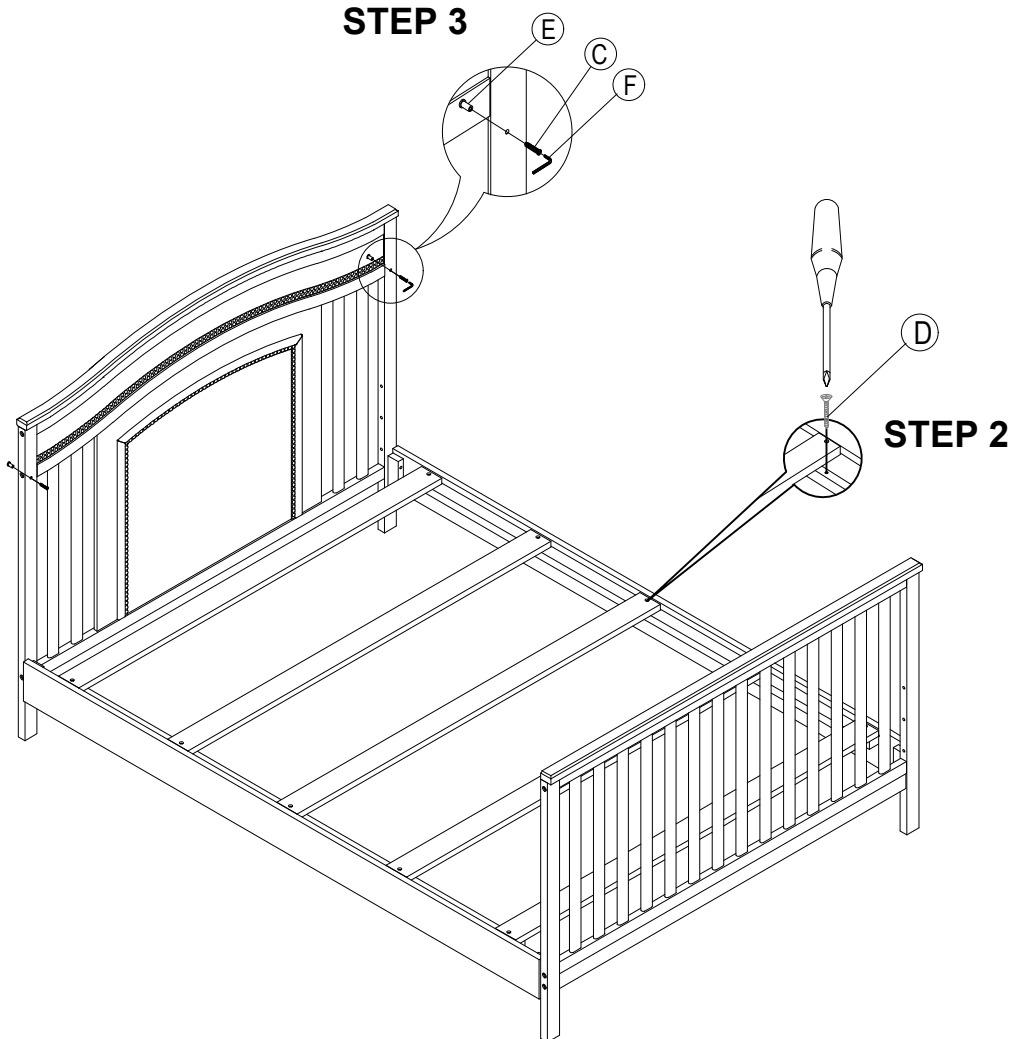

STEP 2:

- After attaching Rails (A) to headboard and footboard, place Slat (B) on the support strip of Rail (A), fasten both ends of Slat (B) with screw (D). Tighten all Screws by Screw Driver (unsupplier).

STEP 3:

- Insert Allenbolt 9/16"(15 mm) (C), through the top hole in the headboard from the inside and connect with nut 3/4" (20 mm) (E). Tighten all bolts and nuts with Allen key (F). Assembly complete. Thank you!

INSTRUCTIONS DE MONTAGE
pour kit de conversion de lit complet
LIT D'ENFANT BRIELLA CONVERTIBLE 4 EN 1
Modèle n° 12688

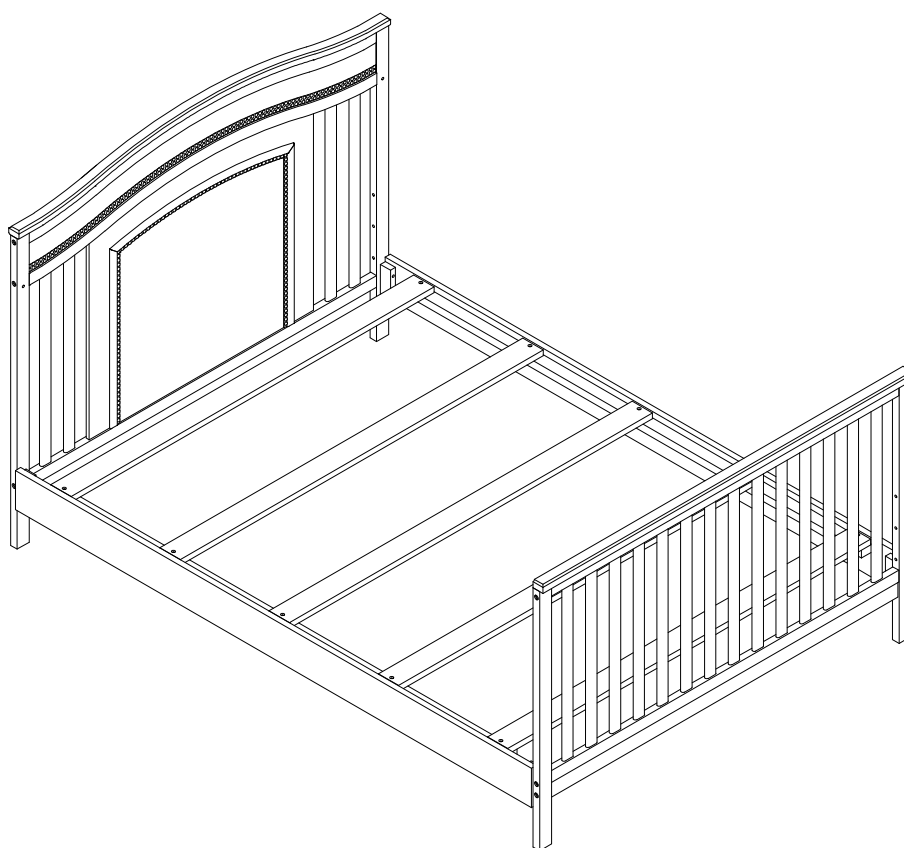

"RECOMMANDATION : nous recommandons l'utilisation d'un cadre à lattes ou d'un sommier sous le matelas pour ce lit complet."

Merci pour votre achat !

Retirez toutes les pièces et le matériel de la boîte et posez-les sur une surface de travail recouverte de moquette

Ne jetez aucun contenu avant la fin du montage.

Familiarisez-vous avec toutes les pièces et les schémas pour faciliter le montage de votre lit d'enfant.

OUTILS NÉCESSAIRES:

CLÉ ALLEN (Inclus)

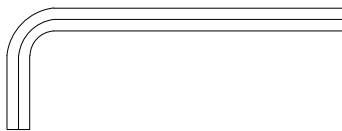

TOURNEVIS (non inclus)

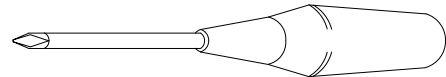

PIÈCES INCLUSES DANS LE CARTON

A. Rail (2 pièces)



B. Lattes (5 pièces)

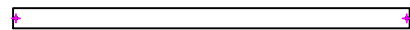

ÉLÉMENTS

(C) Boulons Allen 3/4" (20 mm) (2 pièces)

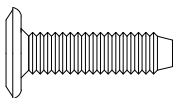

(D) Vis 1 1/4" (32 mm) (10 pièces)

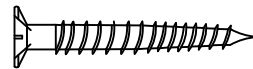

(E) Écrou 3/4 " (20mm) (2 pièces)

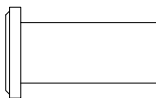

(F) Clé Allen (2 pièces) (la longueur peut varier)



(G) Boulons Allen 2-1/16"(53 mm) (8 pièces)

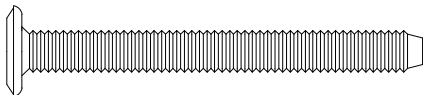

(H) Rondelle à ressort (8 pièces)



Ne serrez pas complètement tous les boulons avant que toutes les pièces ne soient en place.

(veuillez ajouter un 1/2 tour supplémentaire aux boulons lors de l'utilisation de rondelle à ressort après le serrage)

ÉTAPE 1 "MONTAGE DE LA TÊTE DE LIT ET DU PIED DE LIT"

CETTE ÉTAPE EXIGE :

Tête de lit (1 pièce)
Pied de lit (1 pièce)
A. Rail (2 pièces)

(F) Clé Allen (2 pièces)



(G) Boulons Allen 2-1/16"(53 mm) (8 pièces)

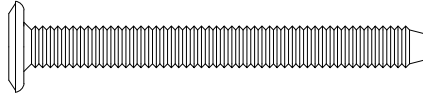

(H) Rondelle à ressort (8 pièces)

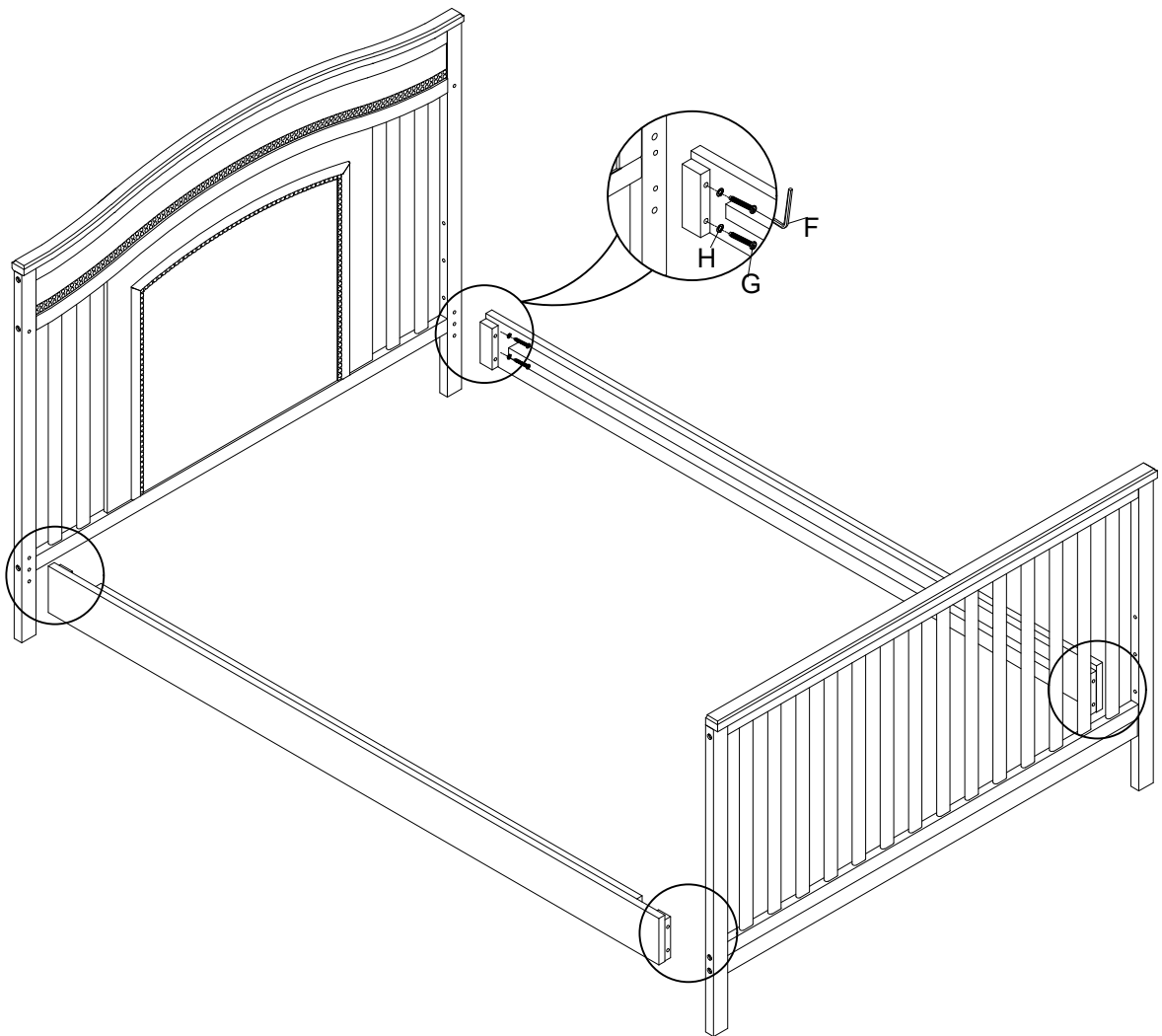

ÉTAPE 1.

Assembler la tête de lit et le pied de lit avec les rails latéraux à l'aide des vis à six pans (G) et des rondelles élastiques (H). Serrer toutes les vis à l'aide de la clé Allen (F).

ÉTAPE 2 "MONTAGE DES LATTES"

CETTE ÉTAPE EXIGE:

B. Lattes (5 pièces)

(F) Clé Allen (2 pièces)



TOURNEVIS (non inclus)

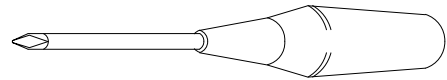

(C) Boulons Allen 3/4"(20 mm) (2 pièces)

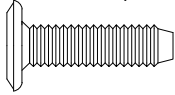

(D) Vis 1 1/4" (32 mm) (10 pièces)

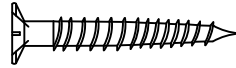

(E) Écrou 3/4 " (20mm) (2 pièces)

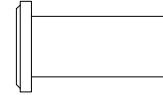

ÉTAPE 3

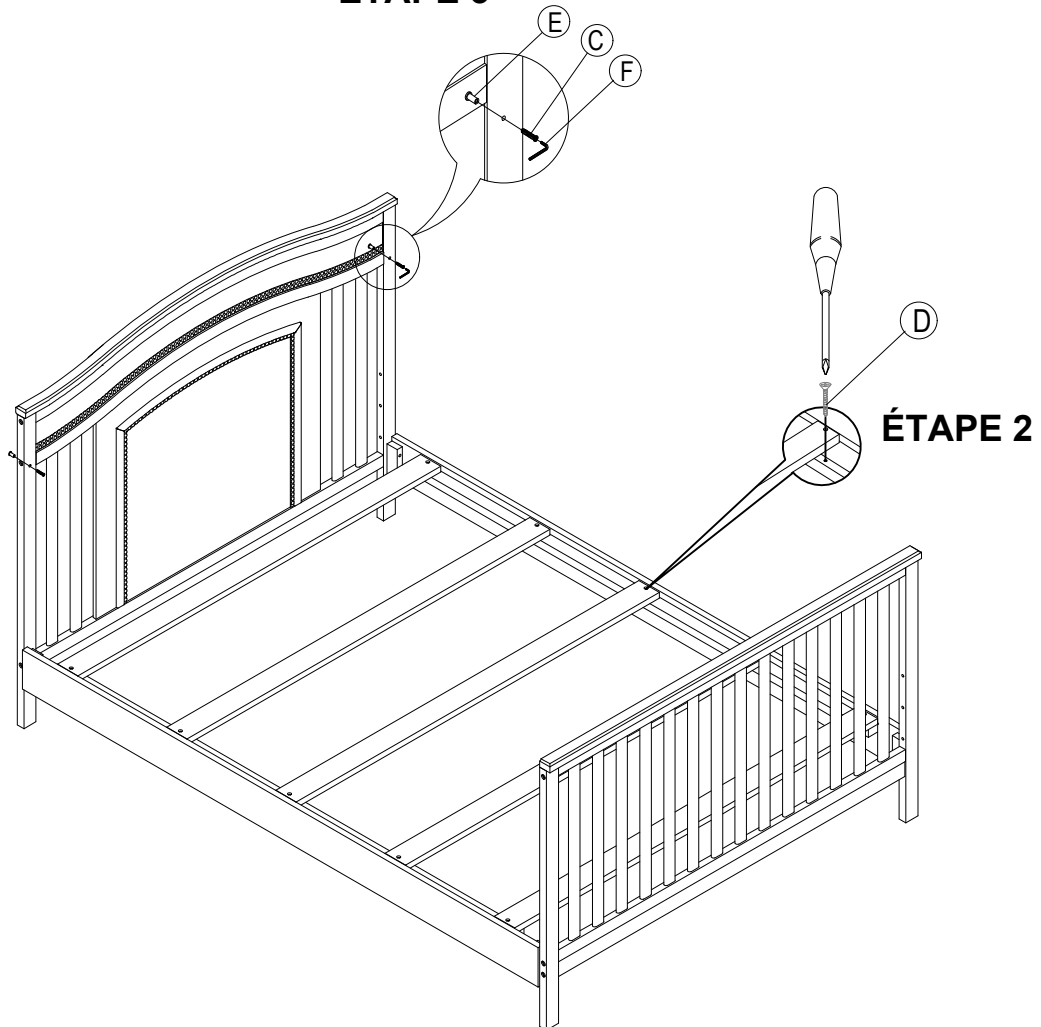

ÉTAPE 2

Après avoir fixé les rails (A) à la tête et au pied de lit, placer les lattes (B) sur les bandes de support des rails (A), puis fixer les deux extrémités des lattes (B) à l'aide des vis (D). Serrer toutes les vis à l'aide d'un tournevis (non fourni).

ÉTAPE 3

Insérer, à partir de l'intérieur du lit, les vis à six pans 20 mm (3/4 po) (C) dans les trous supérieurs de la tête de lit, et les raccorder aux écrous de 20 mm (3/4 po) (E). Serrer toutes les vis et tous les écrous avec la clé Allen (F). Assemblage terminé. Merci!