

ASSEMBLY INSTRUCTIONS

CONSTANTINE COLLECTION







U532T-10 CONSTANTINE CHAIR









Thank you for purchasing this quality product. Be sure to check all packing materials carefully for small parts, which may have come loose inside the carton during shipment. Identify and count all items and compare with the PARTS LIST and/or HARDWARE LIST shown below.

CAUTION: Read the instructions carefully before assembly.

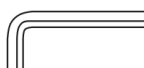
1. We recommend that you assemble this product with the assistance of another person to eliminate damage to the product during assembly.

2. When you want to reposition the product, please always "LIFT & MOVE".

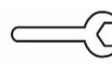
PARTS LIST			
NO.	DESCRIPTION	SKETCH	Q'TY (PCS)
A	SEAT FRAME		1
B	LEFT SIDE FACING (LSF) ARM		1
C	RIGHT SIDE FACING (RSF) ARM		1
D	BACKREST		1
E	SEAT CUSHION		1
F	LEG		2

HARDWARE LIST			
NO.	DESCRIPTION	SKETCH	Q'TY (PCS)
1	FLAT WASHER Ø5/16 x 3/4"		15
2	WASHER Ø5/16 x 1/2"		15
3	BOLT Ø5/16 x 2"		4
4	ALLEN KEY Ø5/16 x 3/4"		1
5	BOLT Ø5/16 x 3/4"		10
6	THREAD BOLT Ø5/16 x 3/4"		1
7	HEX NUT Ø5/16 x 1/2"		1
8	WRENCH 1/2" x 3 1/2"		1
9	SCREWS D4 x 2 3/4"		4

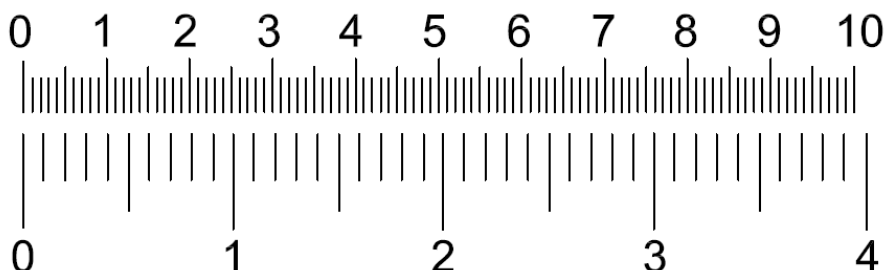

ASSEMBLY INSTRUCTIONS

CONSTANTINE COLLECTION

U532T-10 CONSTANTINE CHAIR

STEP 1:

Place the seat frame (A) upside down. Assemble the legs (F) to both left and right back side of the seat frame (A) by using the Allen Key (4) with hardware 1, 2, and 3.

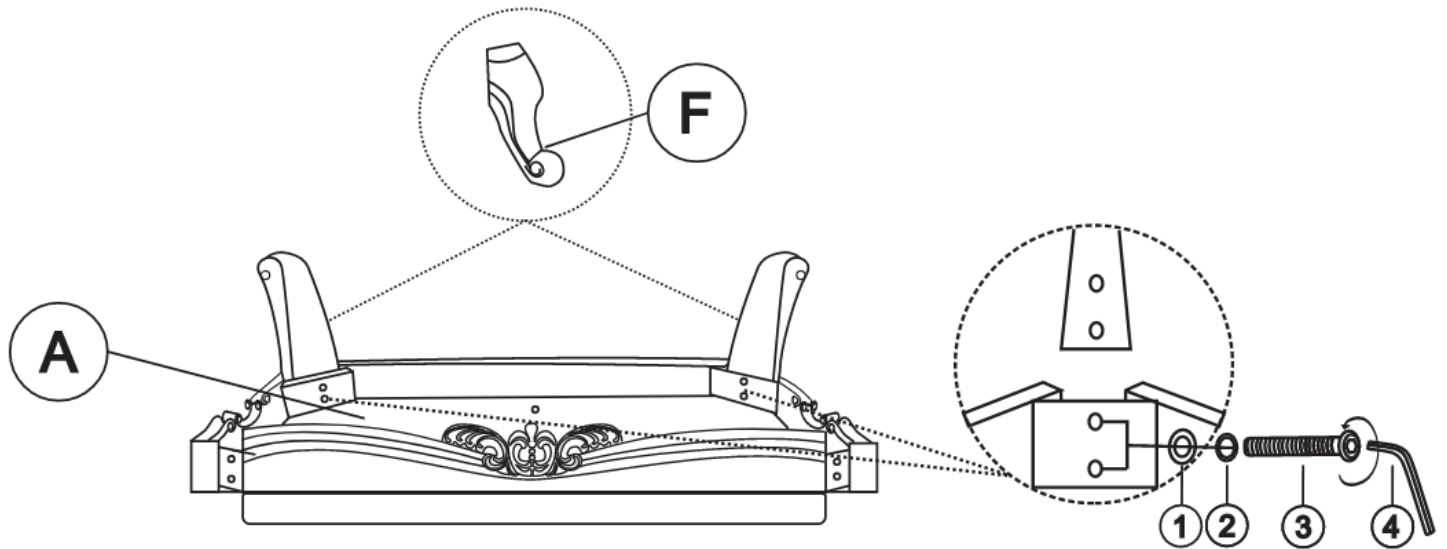

STEP 2:

Lay the seat frame (A) on its backside to reach the holes to secure the bolts for the arms. Align and assemble the LSF arm (B) and RSF arm (C) to the seat frame (A) by using the Allen Key (4) with hardware 1, 2, and 5.

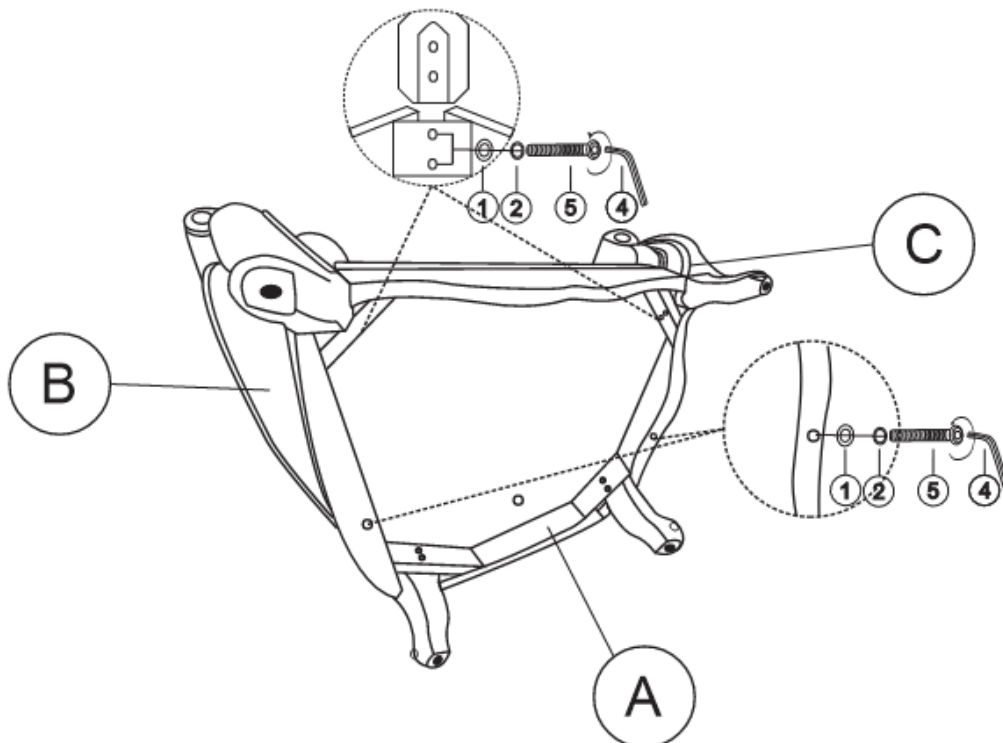

ASSEMBLY INSTRUCTIONS

CONSTANTINE COLLECTION

U532T-10 CONSTANTINE CHAIR

STEP 3:

Assemble and secure the front legs of the LSF arm (B) and RSF arm (C) to the seat frame (A) by using a screwdriver with hardware 9.

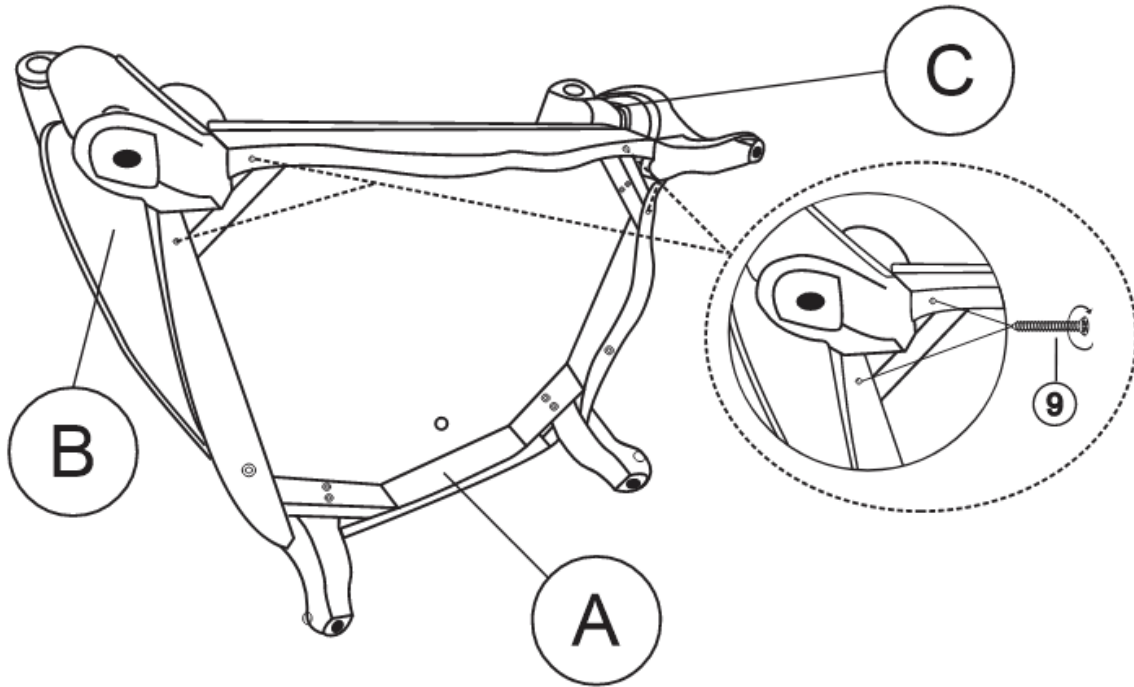

STEP 4:

Place the backrest (D) on its backside. Install the thread bolt (6) into the hole on the bottom of the backrest (D) by using your hands to rotate the bolt about 25 mm into the backrest (D).

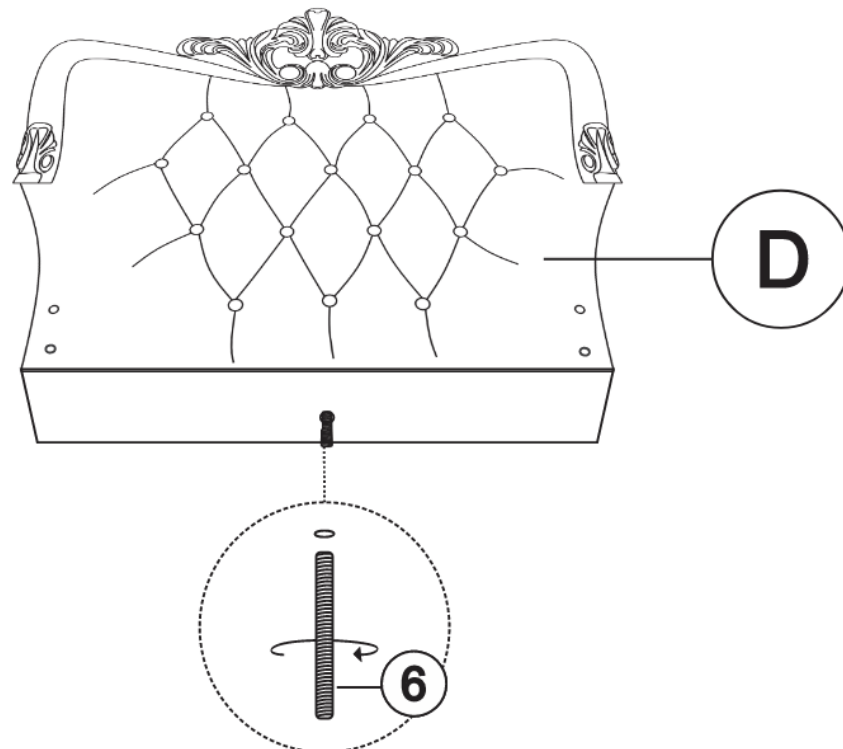

ASSEMBLY INSTRUCTIONS

CONSTANTINE COLLECTION

U532T-10 CONSTANTINE CHAIR

STEP 5:

Place the frame up right and install the backrest (D) to the LSF arm (B) and RSF arm (C) by sliding the brackets all the way until it is secured.

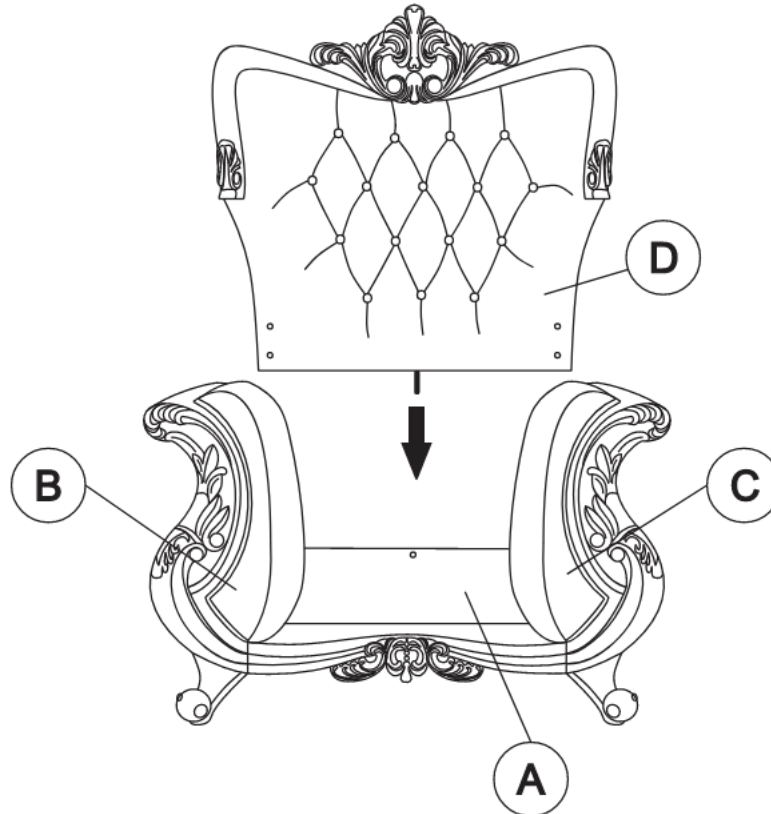

STEP 6:

Open the Velcro cover on the RSF arm (B) and LSF arm (C) to reach the holes to secure the bolts for the backrest. Assemble the backrest (D) to the LSF and RSF arms (B & C) by using Allen Key (4) with hardware 1, 2, and 5.

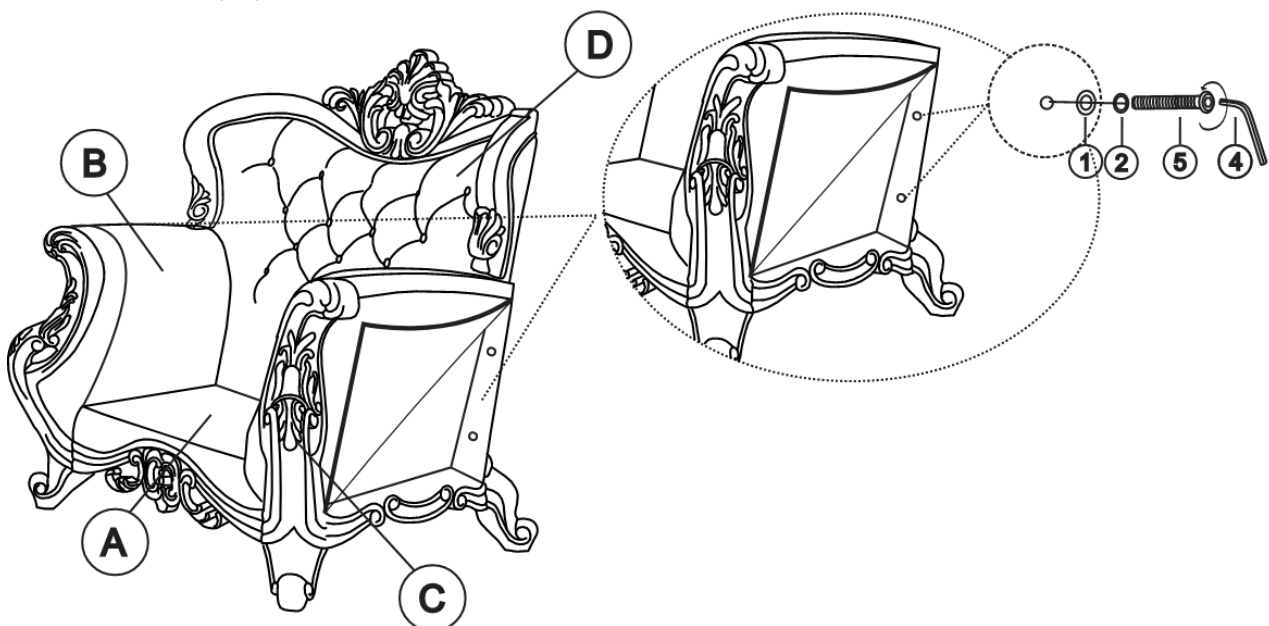

ASSEMBLY INSTRUCTIONS

CONSTANTINE COLLECTION

U532T-10 CONSTANTINE CHAIR

STEP 7:

Place the chair on its back on a clean and soft surface to reach the thread bolt (6). Secure the backrest (D) to the seat frame (A) by using the Wrench (8) with hardware 1, 2, and 7.

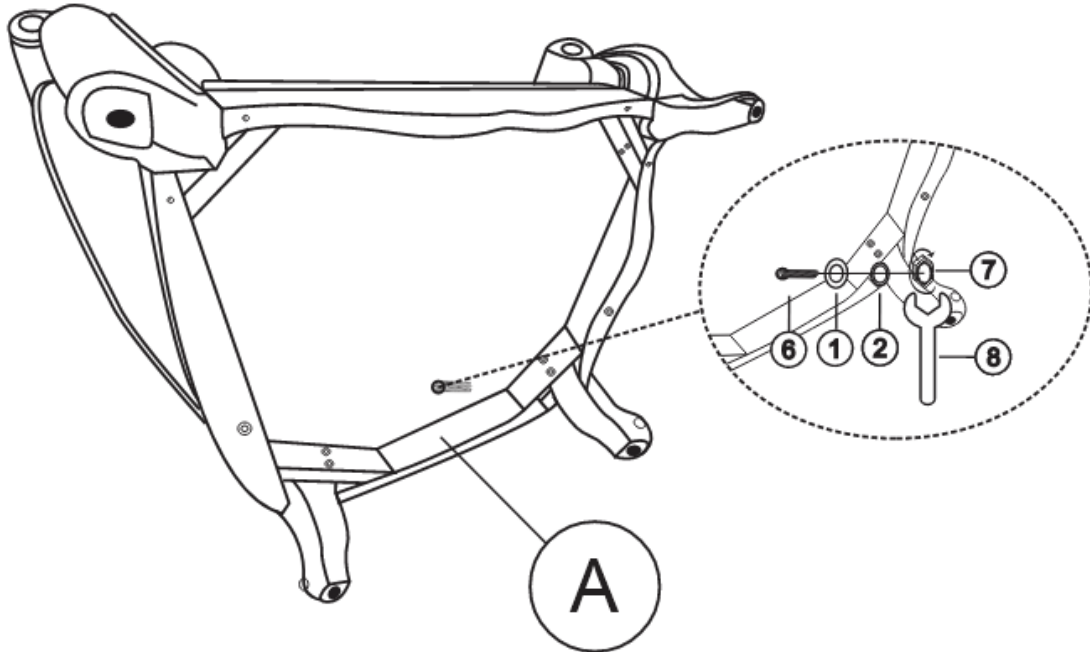

STEP 8:

Place the chair up right and install the seat cushion (E) to the seat frame (A).

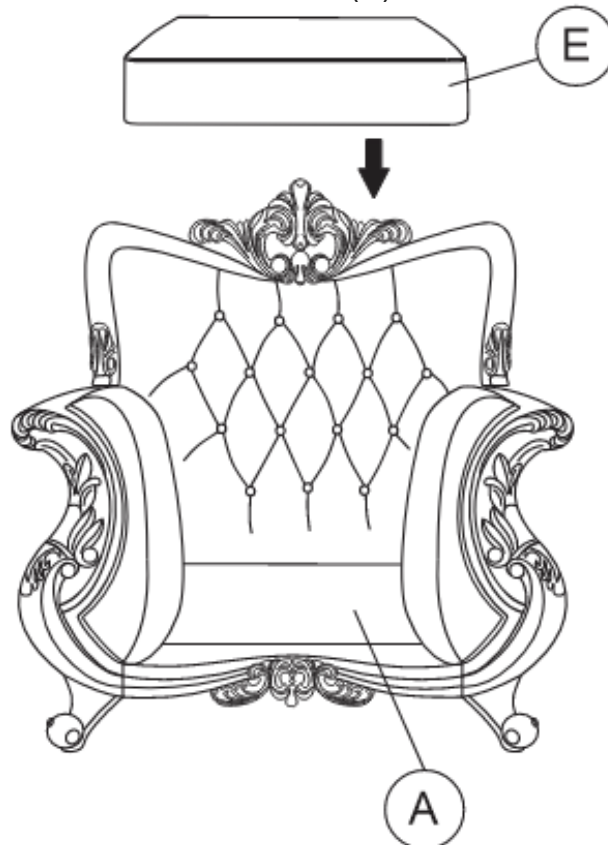

ASSEMBLY INSTRUCTIONS

CONSTANTINE COLLECTION

U532T-10 CONSTANTINE CHAIR

FINISH

