

ASSEMBLY INSTRUCTION

EMPIRE COLLECTION

EMPIRE LIGHTED SOFA



U2034-30



Thank you for purchasing this quality product. Be sure to check all packing materials carefully for small parts, which may have come loose inside the carton during shipment. Identify and count all items and compare with the parts list and/or hardware list shown below.

Please read all instructions carefully. See the hardware and furniture part listing for guidance. Be sure you have all parts listed before beginning assembly. Place all wooden parts on a clean, flat surface to protect the finish from scratches. Follow the diagram to assemble.

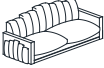
CAUTION

1. Do not fully tighten the nuts or bolts until the table is fully assembled.
2. Please tighten by hand, not by a drill. Overtightening will damage threads. Do not overtighten.
3. Keep all hardware out of the reach of children.
4. It is recommended to have two people during assembling and to remove the back and base of the furniture out from the box.
5. Please always "LIFT UP & MOVE" the upholstery when you want to reposition it.

PARTS LIST			
ITEM	DESCRIPTION	SKETCH	QTY
A	SOFA		1 PC
B	LEG		4 PCS
C	PLUG		1 PC

HARDWARE LIST			
ITEM	DESCRIPTION	SKETCH	QTY
1	BOLT M6 x 5/8"		16 PCS
2	ALLEN KEY M4 x 4"		1 PC

HARDWARE DIMENSIONS
VERIFICATION TOOL

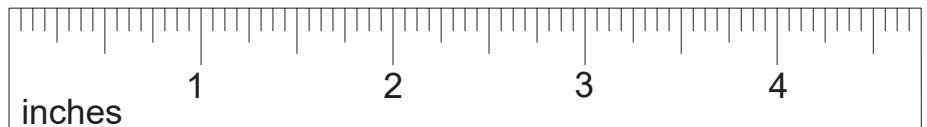

STEP 1: Place the Sofa (A) on its back on a soft and clean surface. Assemble the Legs (B) to the Sofa (A) by using the Allen Key (2) with hardware 1.

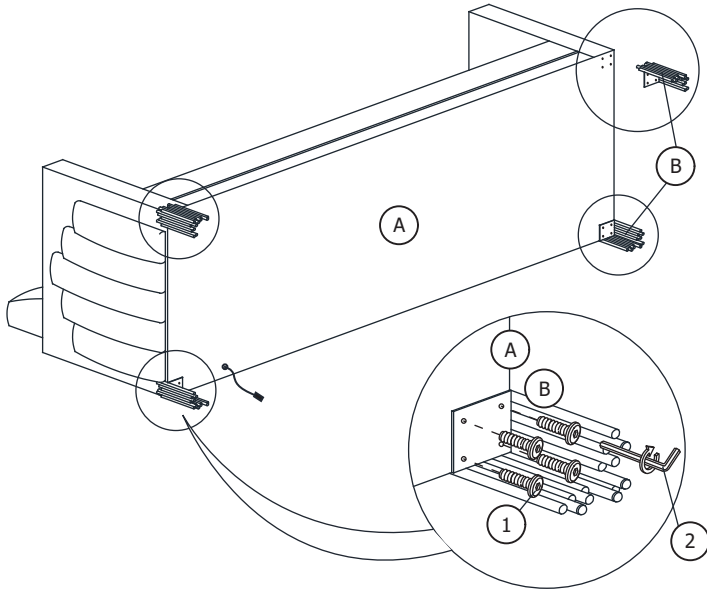

STEP 2: Connect the Plug (C) with the connecting wire on the Sofa (A).

REMARK : Touch the sensor to turn on the light and adjust the level of brightness.

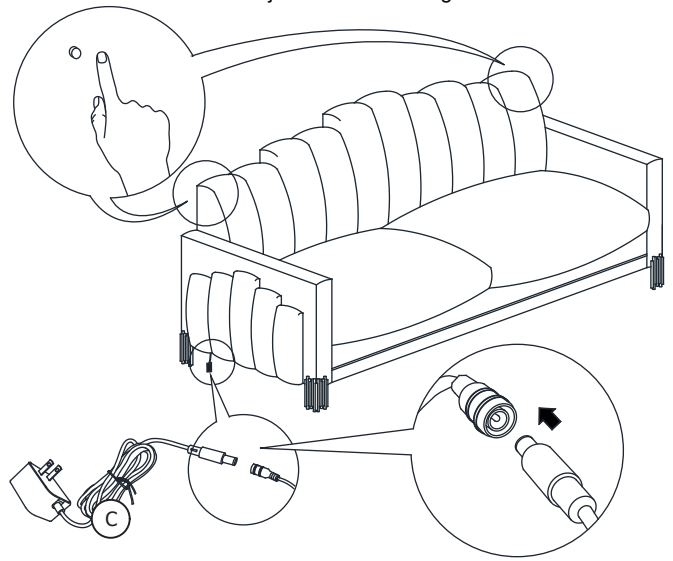

STEP 3:

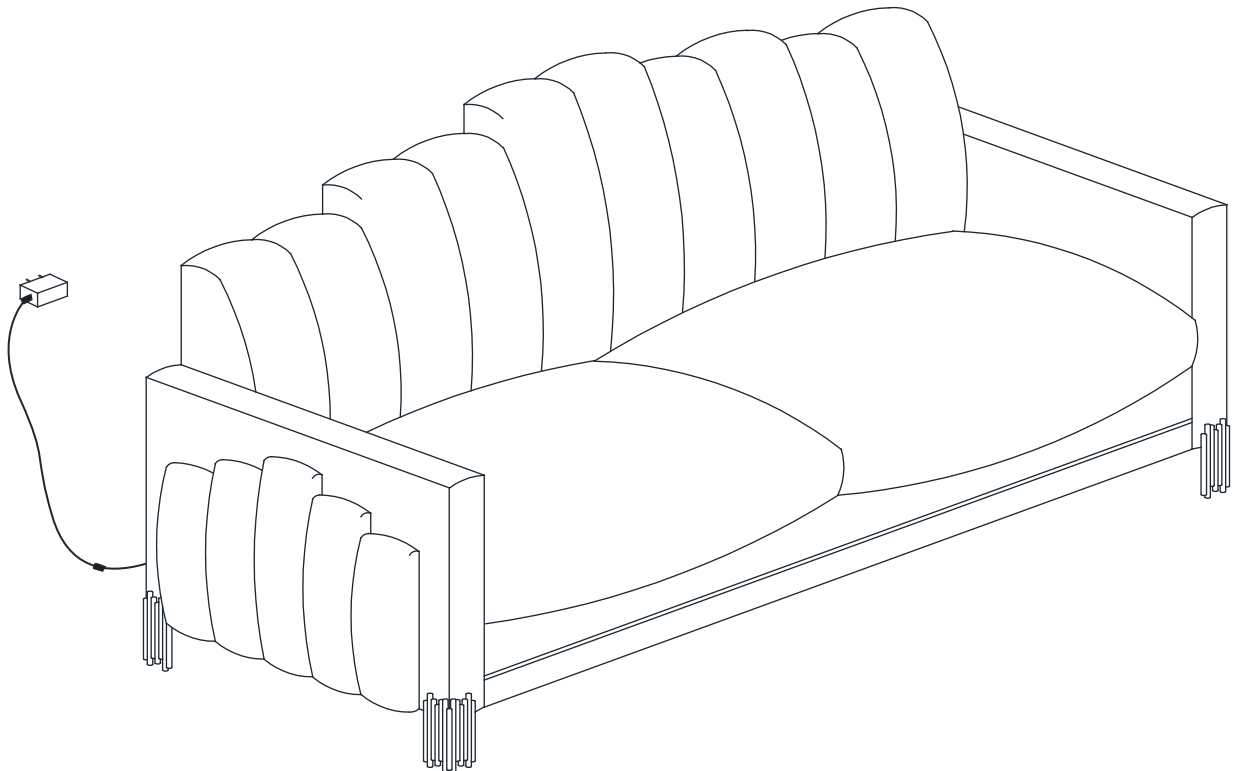

ASSEMBLY COMPLETED
MADE IN MALAYSIA