

# ASSEMBLY INSTRUCTIONS

## PALAZZO MARINA COLLECTION





U1808-20A  
U1808-20B



PALAZZO MARINA LOVESEAT FRAME, CUSHION, ARMS, LEGS & 3 PILLOWS  
PALAZZO MARINA LOVESEAT BACKREST

Thank you for purchasing this quality product. Be sure to check all packing materials carefully for small parts, which may have come loose inside the carton during shipment. Identify and count all items and compare with the PARTS LIST and/or HARDWARE LIST shown below.

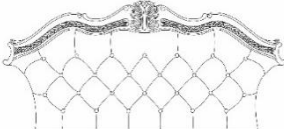
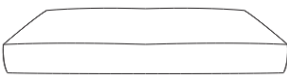
**CAUTION: Read the instructions carefully before assembly.**

1. We recommend that you assemble this product with the assistance of another person to eliminate damage to the product during assembly.
2. When you want to reposition the product, please always "LIFT & MOVE."

PARTS LIST			
NO.	DESCRIPTION	SKETCH	Q'TY (PCS)
A	SEAT FRAME		1
B	LEFT SIDE FACING (LSF) ARM		1
C	RIGHT SIDE FACING (RSF) ARM		1
D	BACKREST		1
E	SEAT CUSHION		1
F	LEG		4

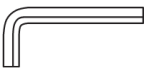
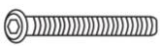
HARDWARE LIST			
NO.	DESCRIPTION	SKETCH	Q'TY (PCS)
1	FLAT WASHER Ø5/16 x 3/4"		11
2	WASHER Ø5/16 x 1/2"		11
3	BOLT Ø5/16 x 2 1/4"		8
4	ALLEN KEY Ø5/16 x 3/4"		1
5	BOLT Ø5/16 x 3/4"		3

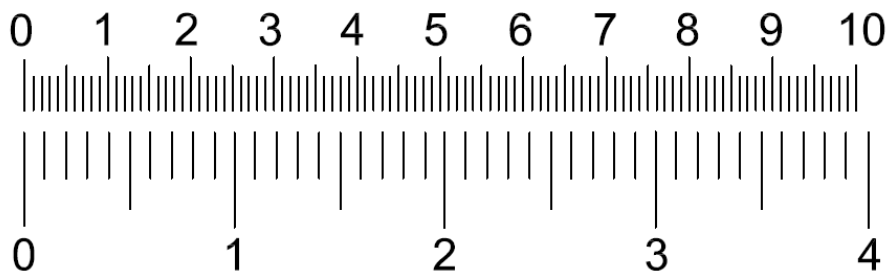

# ASSEMBLY INSTRUCTIONS

## PALAZZO MARINA COLLECTION

U1808-20A  
U1808-20B

PALAZZO MARINA LOVESEAT FRAME, CUSHION, ARMS, LEGS & 3 PILLOWS  
PALAZZO MARINA LOVESEAT BACKREST

### STEP 1:

Lay the seat frame (A) on its back side to reach the holes to secure the bolts for the arms. Assemble the LSF arm (B) and RSF arm (C) to the seat frame (A) using Allen Key (4) with hardware, 1, 2, and 3.

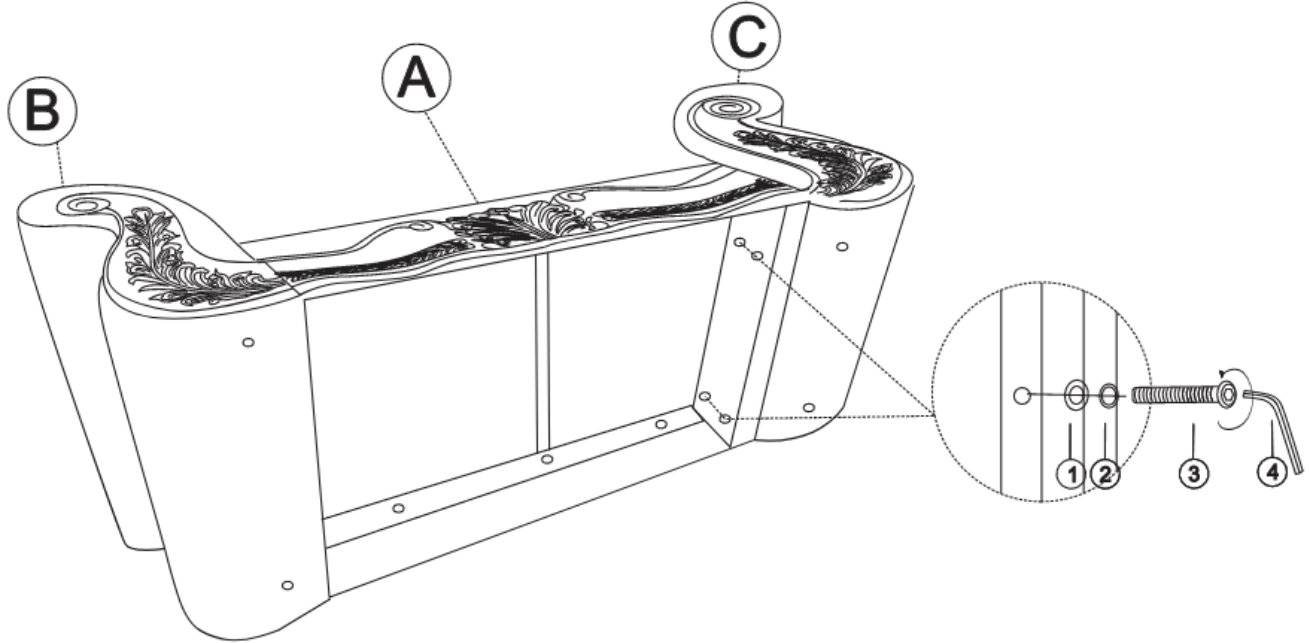

### STEP 2:

Align and install the legs (F) to the bottom of the arms (B & C)

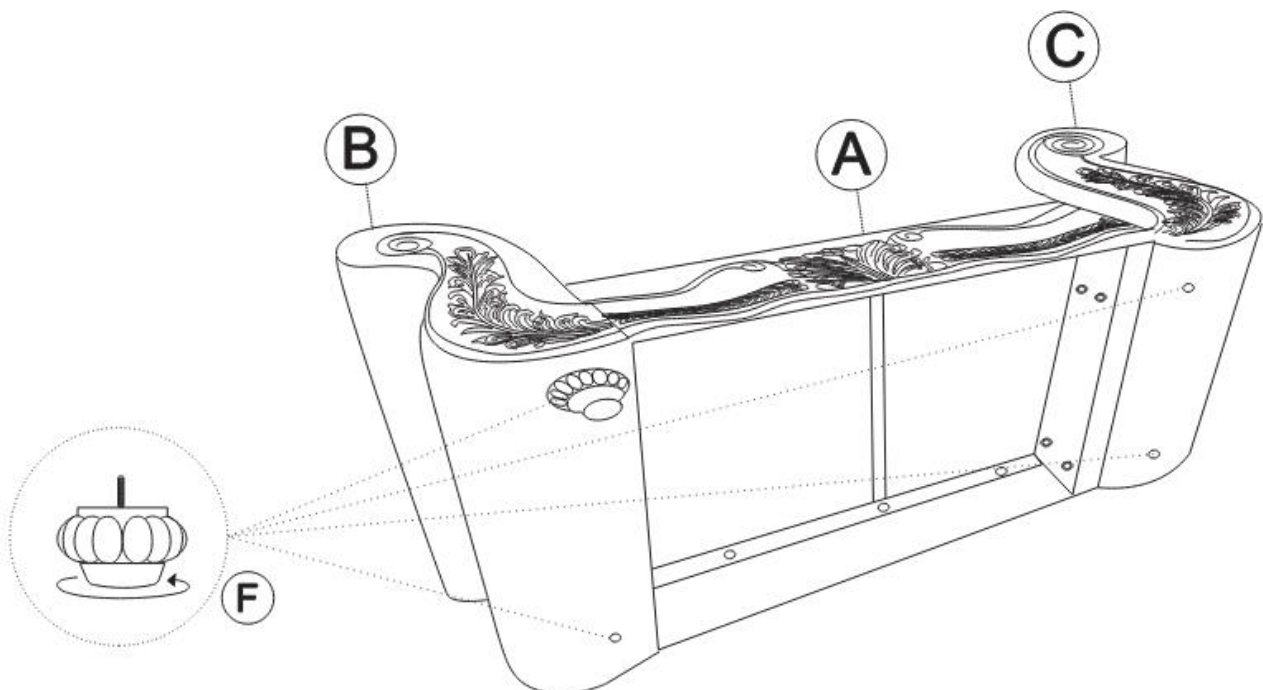

# ASSEMBLY INSTRUCTIONS

## PALAZZO MARINA COLLECTION

U1808-20A  
U1808-20B

PALAZZO MARINA LOVESEAT FRAME, CUSHION, ARMS, LEGS & 3 PILLOWS  
PALAZZO MARINA LOVESEAT BACKREST

### STEP 3:

Place the frame up right and install the backrest (D) to the LSF arm (B) and RSF arm (C) by sliding the brackets all the way until it is secured.

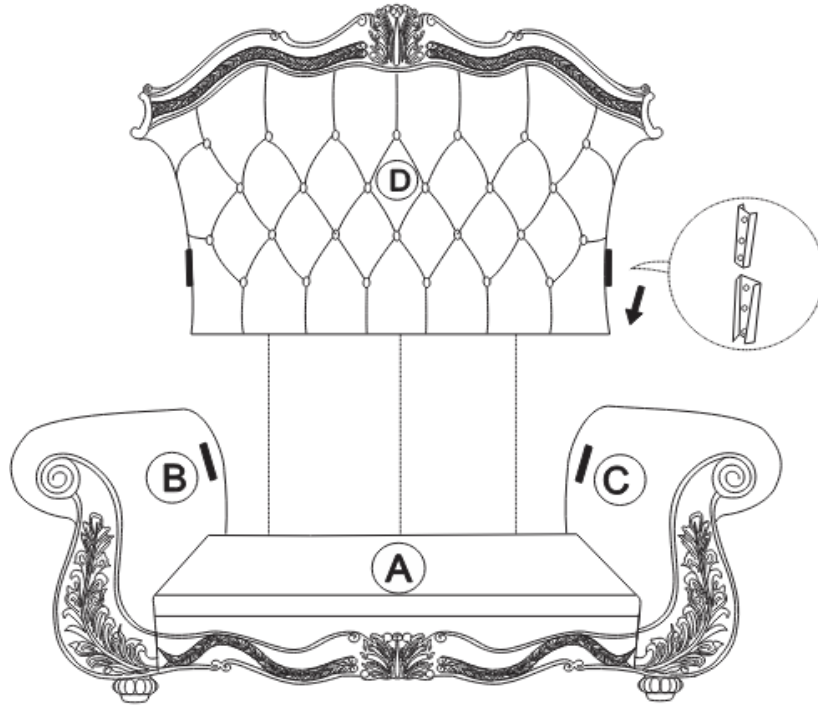

### STEP 4:

Place the chair on its back on a clean and soft surface and secure the bolts for the chair back (D) at bottom the seat frame (A) by using the Allen key (4) with hardware 1,2 and 5.

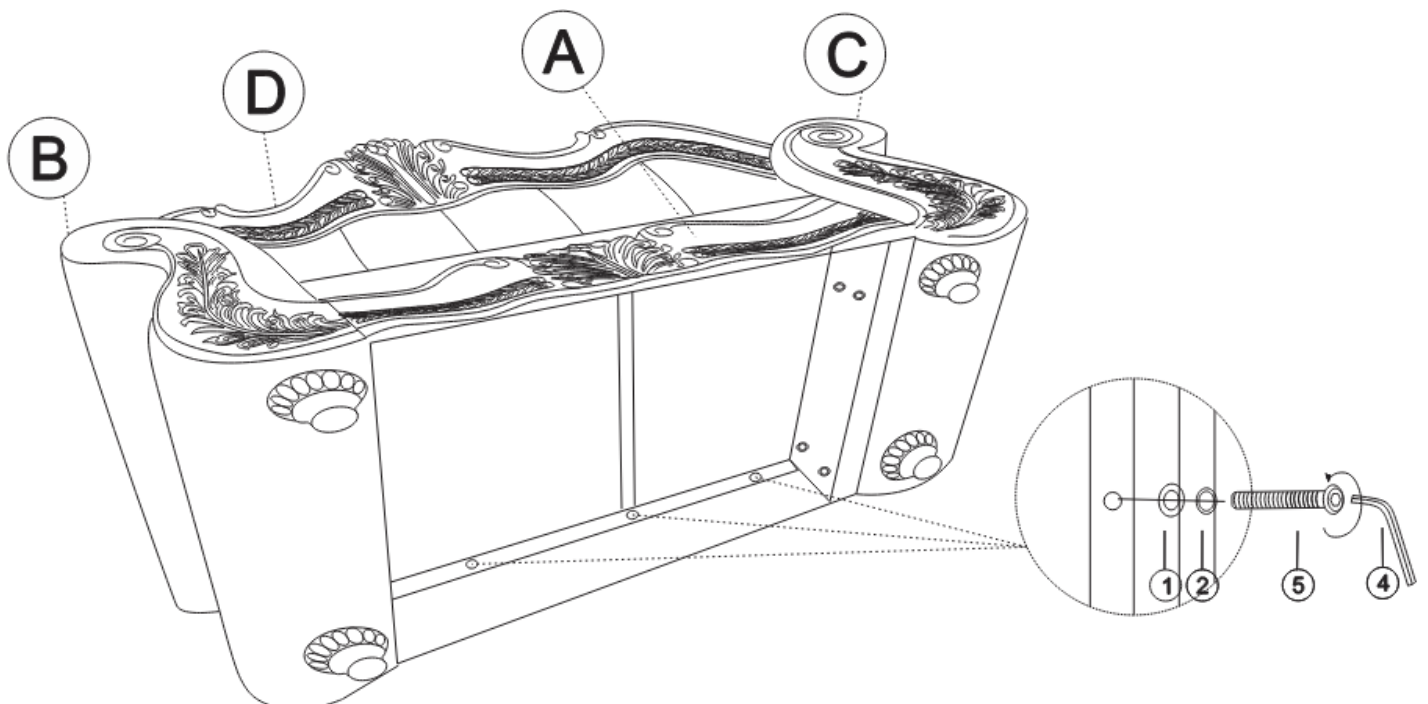

# ASSEMBLY INSTRUCTIONS

## PALAZZO MARINA COLLECTION

U1808-20A  
U1808-20B

PALAZZO MARINA LOVESEAT FRAME, CUSHION, ARMS, LEGS & 3 PILLOWS  
PALAZZO MARINA LOVESEAT BACKREST

---

### STEP 5:

Place the frame up right and place the seat cushion (E) to the seat frame.

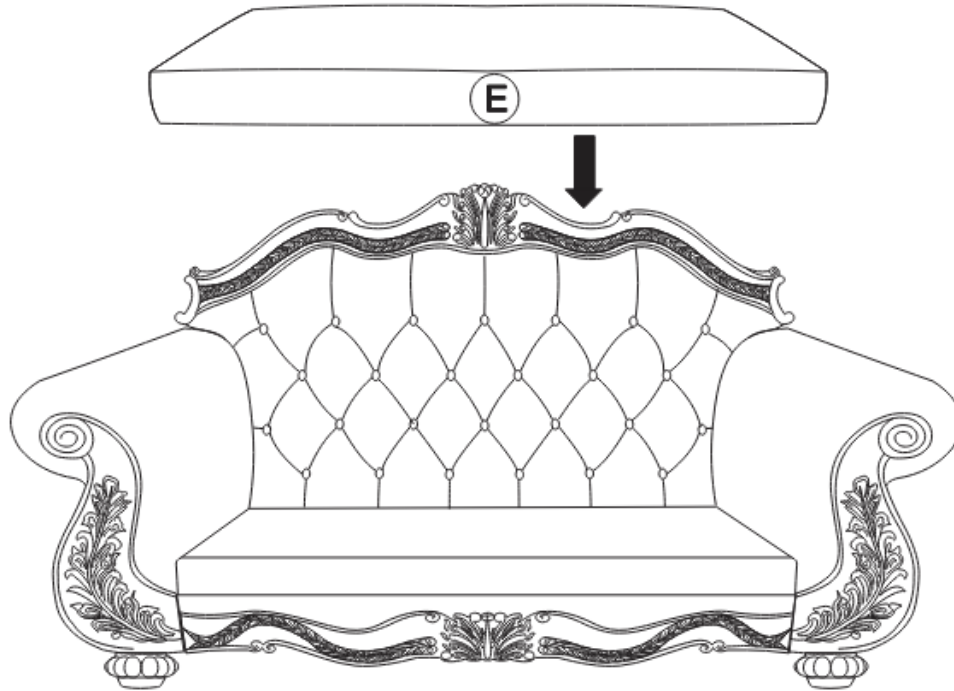

### FINISH

