







ASSEMBLY INSTRUCTIONS

BRAVO COLLECTION

ITEM#: U1165-13-SLP

DESCRIPTION : BRAVO GLIDER RECLINER-CHARCOAL

Thank you for purchasing this quality product. Be sure to check all packing materials carefully for small parts, which may have come loose during shipment. Identify and count all items and compare with the parts list shown below. It is recommended to have two people during assembling and to remove the back and base of the furniture out from the box. **Please follow the drawings below to assemble the item**

Parts List			
NO.	DESCRIPTION	SKETCH	Q'TY
A	Seat		1 PC
B	Backrest		1 PC
C	Left Wing		1 PC
D	Right Wing		1 PC

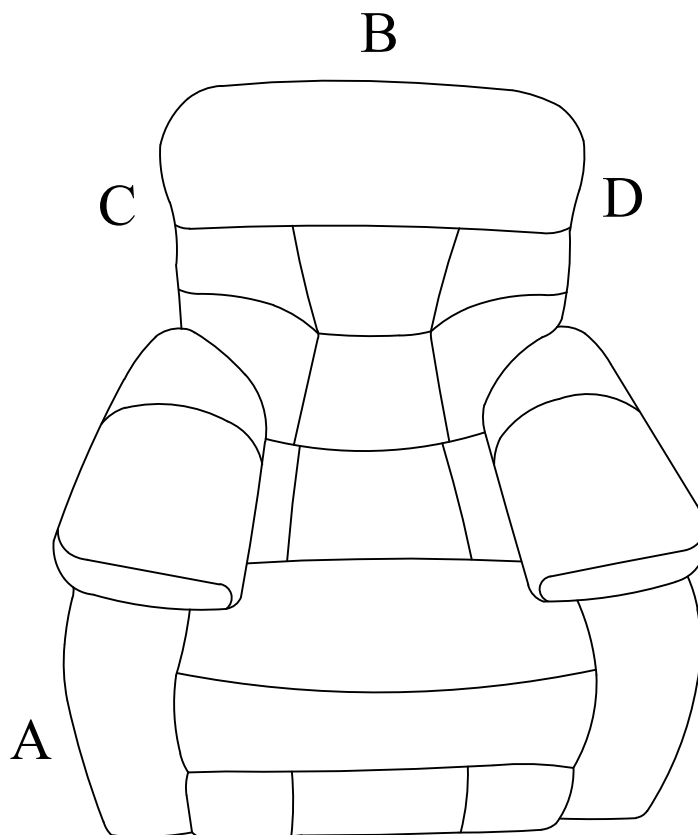

All images shown are for illustration purpose only.
Actual product may vary due to product enhancement.

ASSEMBLY INSTRUCTIONS

BRAVO COLLECTION

ITEM#: U1165-13-SLP

DESCRIPTION : BRAVO GLIDER RECLINER-CHARCOAL

Step 1:

Attach Backrest (B) to the Seat (A)

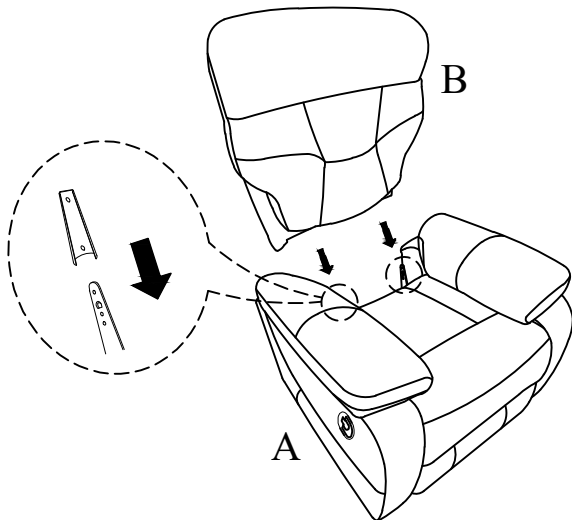

Step 2:

Attach the Left Wing (C) and Right Wing (D) to Backrest (B)

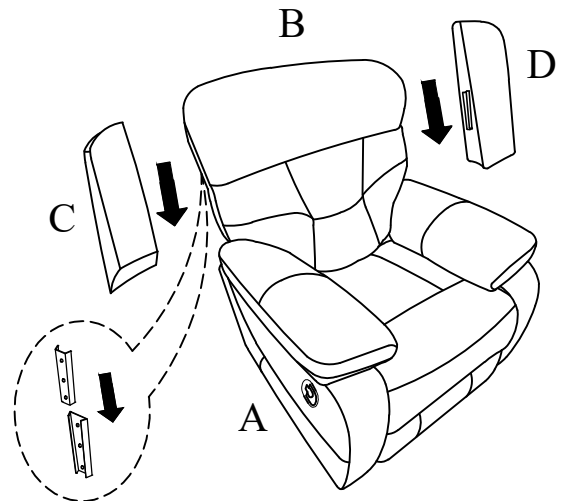

Step 3:

Open the footrest by pulling the handle

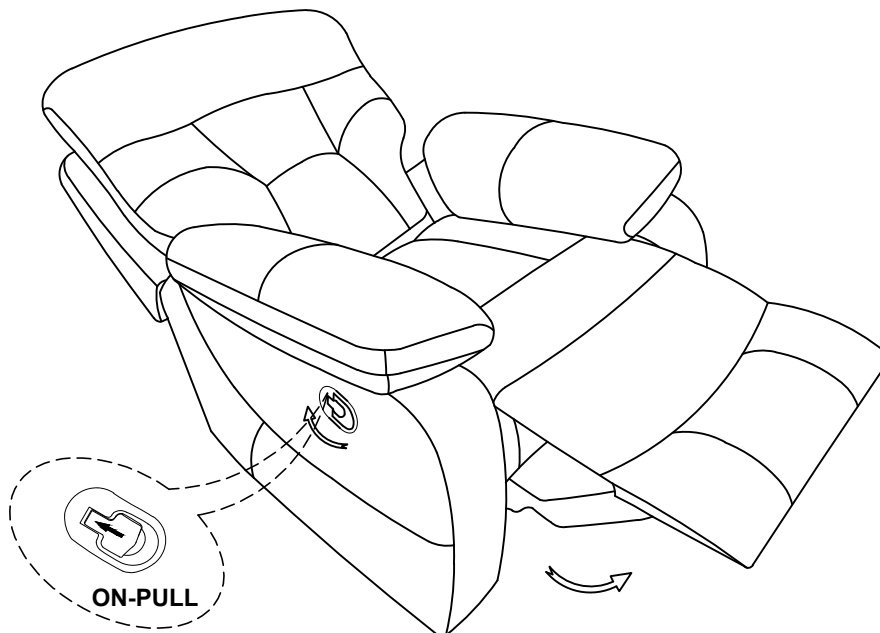

All images shown are for illustration purpose only.
Actual product may vary due to product enhancement.