

ASSEMBLY INSTRUCTIONS



MAXIMUS COLLECTION





T1754-10 – MAXIMUS MARBLE COCKTAIL TABLE

Thank you for purchasing this quality product. Be sure to check all packing materials carefully for small parts, which may have come loose inside the carton during shipment. Identify and count all items and compare with the PARTS LIST and/or HARDWARE LIST shown below.

CAUTION: Read the instructions carefully before assembly.

1. We recommend that you assemble this product with the assistance of another person to eliminate damage to the product during assembly.
2. When you want to reposition the product, please always "LIFT & MOVE."

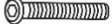
PARTS LIST			
NO.	DESCRIPTION	SKETCH	Q'TY (PCS)
A	WOOD TABLE TOP		1
B	LEG		4

HARDWARE LIST			
NO.	DESCRIPTION	SKETCH	Q'TY (PCS)
1	FLAT WASHER Ø5/16 x 3/4"		8
2	WASHER Ø5/16 x 1/2"		8
3	BOLT Ø5/16 x 3/4"		8
4	ALLEN KEY Ø5/16 x 3/4"		1

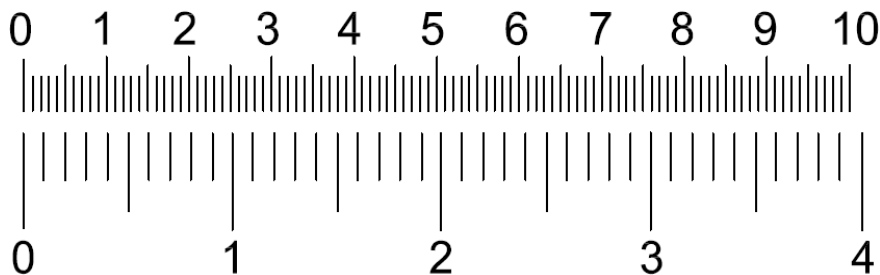

ASSEMBLY INSTRUCTIONS

MAXIMUS COLLECTION

T1754-10 – MAXIMUS MARBLE COCKTAIL TABLE

STEP 1:

Place the wood table top (A) face down on a clean and soft surface. Assemble the Legs (B) to the wood table top (A) by using Allen key (4) with hardware, 1,2, and 3.

DO NOT TIGHTEN THE SCREWS

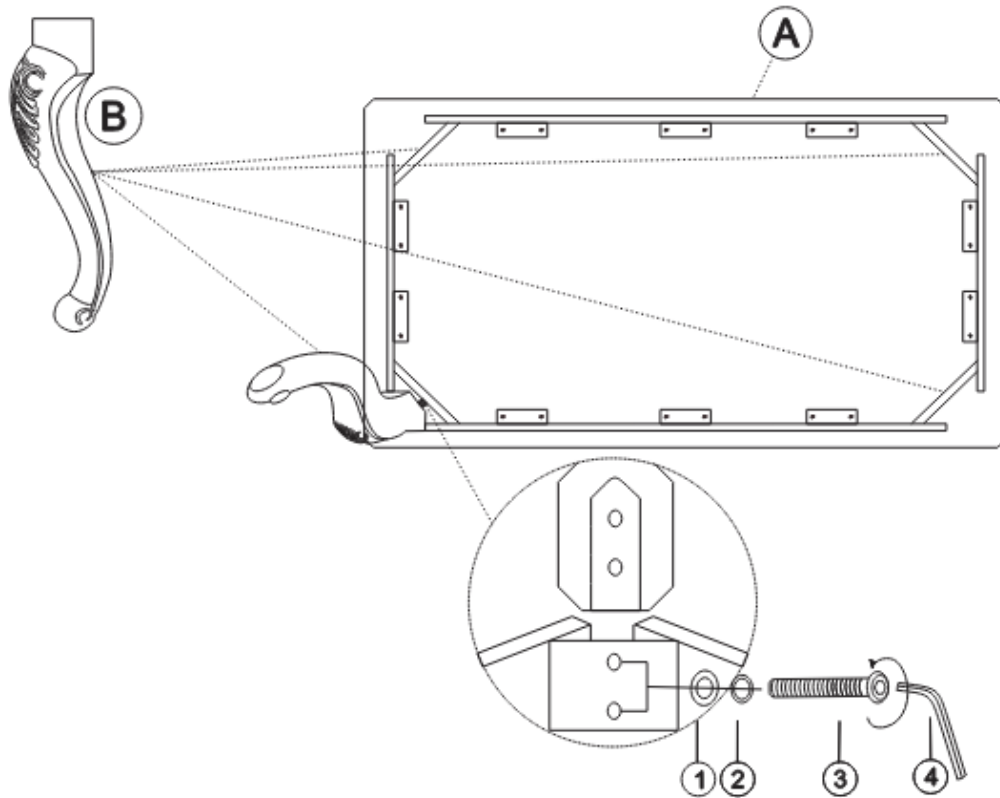

STEP 2:

To level the table, place the table up right on a flat surface then tighten all screws by using Allen Key (4).

