







Thank you for purchasing this quality product. Be sure to check all packing materials carefully for small parts, which may have come loose inside the carton during shipment. Identify and count all items and compare with the parts list and/or hardware list shown below.

PARTS LIST			
No.	DESCRIPTION	SKETCH	Q'TY
A	SEAT		1
B	LEG		4

HARDWARE LIST			
No.	DESCRIPTION	SKETCH	Q'TY
1	ALLEN BOLT (5/16" x2")		8
2	SPRING WASHER (5/16" *Ø12MM)		8
3	FLAT WASHER (5/16" Ø19MM)		8
4	ALLEN KEY		1

STEP : 1

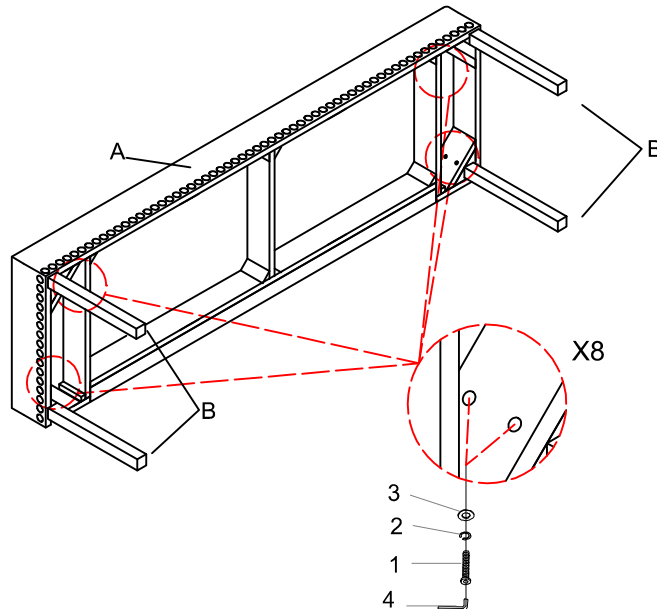

STEP : 2

