







Thank you for purchasing this quality product. Be sure to check all packing materials carefully for small parts, which may have come loose inside the carton during shipment. Identify and count all items and compare with the parts list and/or hardware list shown below.

Please read all instructions carefully. See the hardware and furniture part listing for guidance. Be sure you have all parts listed before beginning assembly. Place all wooden parts on a clean, flat surface to protect the finish from scratches. Follow the diagram to assemble.

CAUTION

1. Do not fully tighten the nuts or bolts until the table is fully assembled.
2. Please tighten by hand, not by a drill. Overtightening will damage threads. Do not overtighten.
3. Keep all hardware out of the reach of children.

PART LIST			
ITEM	DESCRIPTION	SKETCH	QTY
A	CROSS BAR -UP		2 PCS
B	CROSS BAR -DOWN		2 PCS
C	LEGS		8 PCS
D	ROUND STRETCHER		2 PCS
E	SEAT WITH FRAME		2 PCS
F	BACK FRAME		2 PCS

HARDWARE LIST			
ITEM	DESCRIPTION	SKETCH	QTY
1	SWIVEL PLATE		2 PCS
2	JCBB M6 x 25mm		16 PCS
3	JCBC M6 x 35mm		8 PCS
4	JCBC M6 x 40mm		4 PCS
5	JCBC M6 x 50mm		8 PCS
6	JCBC M6 x 60mm		8 PCS
7	SPRING WASHER 1/4"		20 PCS
8	FLAT WASHER 1/4"		12 PCS
9	M4 ALLEN KEY (LONG)		1 PC
10	WOOD BUTTON		8 PCS



STEP 1

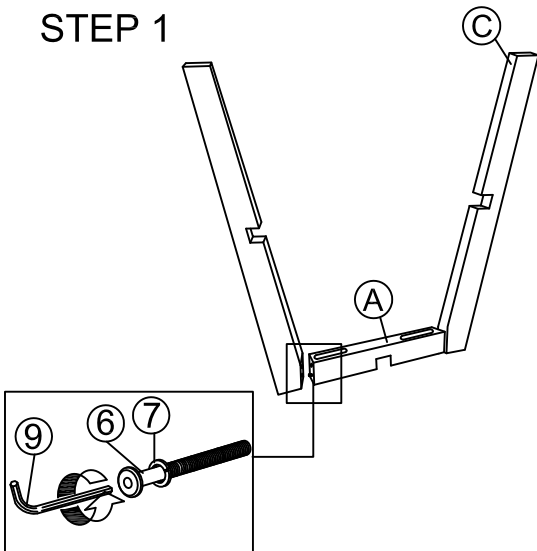

STEP 2

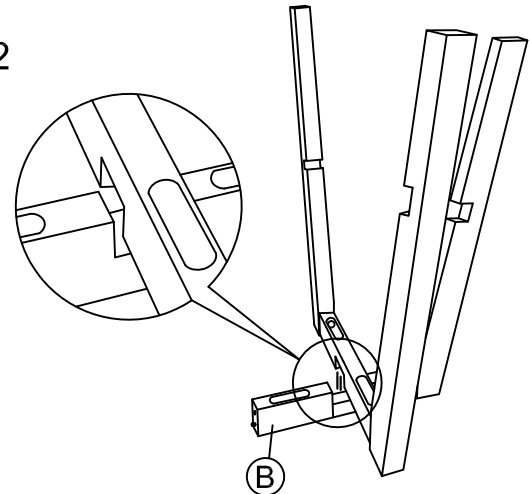

STEP 3

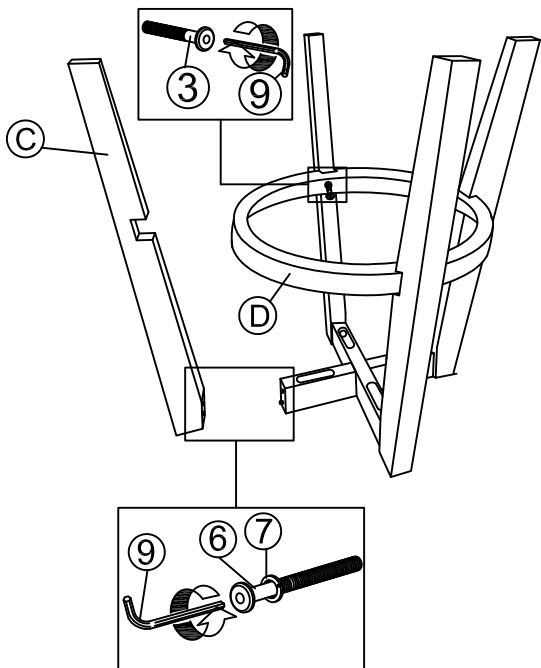

STEP 4

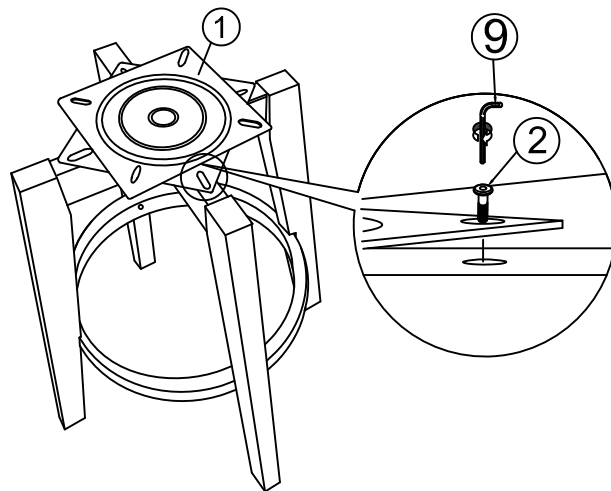

STEP 5

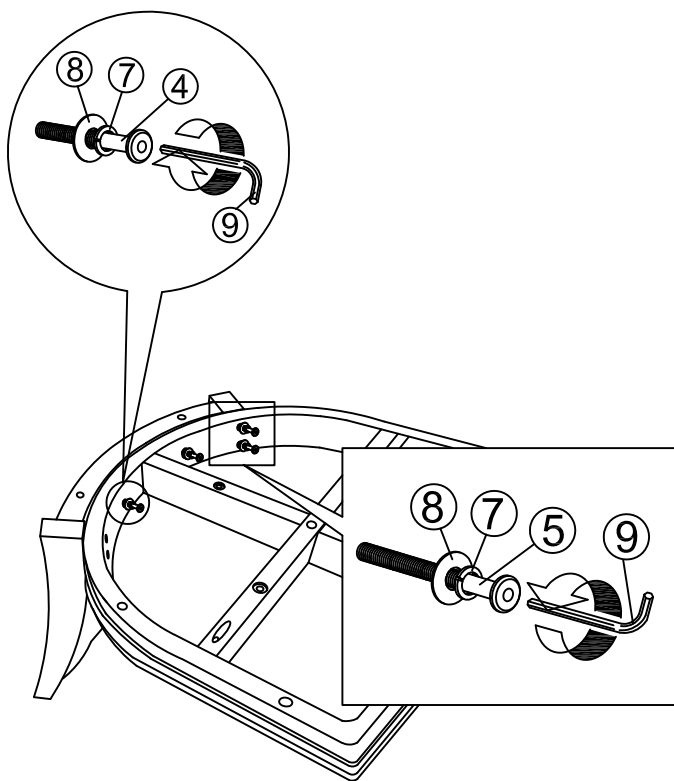

STEP 6

