

Assembly Instructions





D7624-25 Montecito Arm Chair

Thank you for purchasing this quality product. Be sure to check all packing materials carefully for small parts, which may have come loose inside the carton during shipment. Identify and count all items and compare with the PARTS LIST and/or HARDWARE LIST shown below.



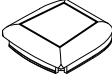





Caution: Please read the instructions thoroughly before assembly.

1. We recommend that you assemble this product with the assistance of another person: this will make the assembly easier, and will help eliminate damage to the product or injury to persons during assembly.
2. Please do not over tighten screws or bolts until the assembly is completed.
3. Please put all parts on a non-abrasive floor before assembly, and follow the assembly steps to assemble your newly purchased product correctly and efficiently

PARTS LIST

NO:	COMPONENT	DRAWING	Q'TY
A	Chair Back		2PCS
B	Seat		2PCS
C	Leg		4PCS
D	LSF Arm		2PCS
E	RSF Arm		2PCS

HARDWARE LIST

NO:	COMPONENT	DRAWING	Q'TY
1	Bolt Ø5/16"x2-3/4"		16pcs
2	Lock Washer Ø5/16"		16pcs
3	Flat Washer Ø5/16"x3/4"		16pcs
4	Open Wrench 90*12		2pcs
5	Bolt Ø1/4"x1-1/2"		10pcs
6	Lock Washer Ø1/4"		10pcs
7	Flat Washer Ø1/4"x5/8"		10pcs
8	Allen key		2pcs
9	Screw: #8*1-3/4"		4pcs

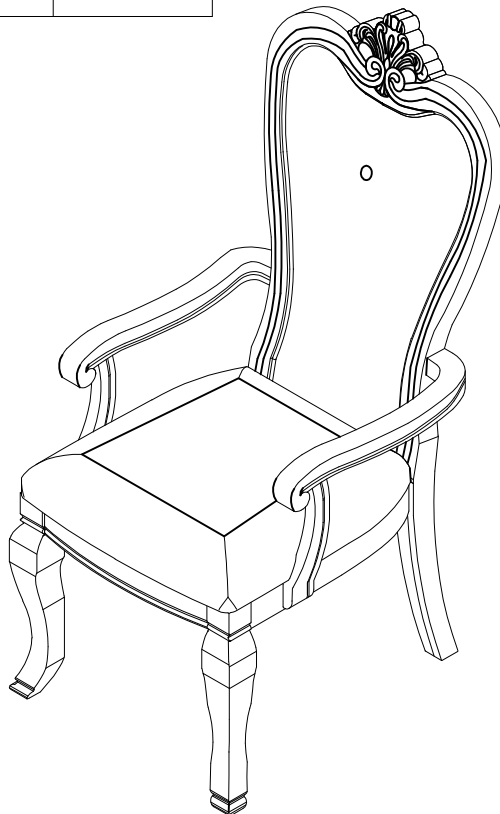

Assembly Instructions

D7624-25 Montecito Arm Chair

STEP 1

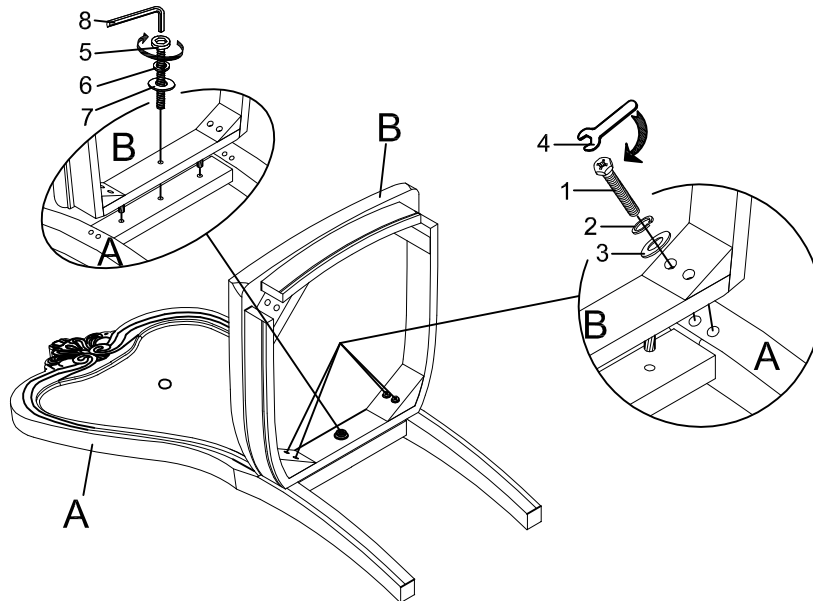

STEP 2

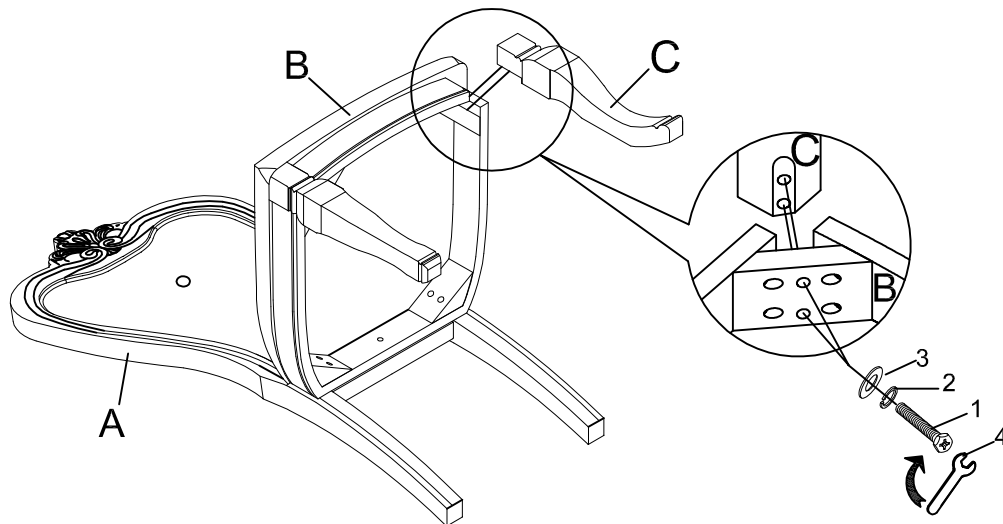

STEP 3

