



Assembly Instructions

COLLECTION : TRELLIS

ITEM NO : D5030-20 DINING CHAIR
(2 PER CARTON)



Thank you for purchasing this quality product. Be sure to check all packing materials carefully for small parts, which may have come loose inside the carton during shipment. Identify and count all items and compare with the PARTS LIST and/or HARDWARE LIST shown below.



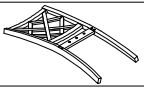

Please read the instructions thoroughly before assembly.

1. We recommend that you assemble this product with the assistance of another person; this will make the assembly easier, and will help eliminate damage to the product or injury to persons during assembly.
2. Please do not tighten screws or bolts until the assembly is completed.
3. To level the chairs or table, before tightening all the screws, the chairs or table must be placed on a flat surface and then tighten the screws.
4. Please put all parts on a non-abrasive floor before assembly and follow the assembly steps to assemble your newly purchased product correctly and efficiently.

PARTS LIST

NO.	DESCRIPTION	SKETCH	QTY
A	CHAIR BACK		1 PC
B	SEAT		1 PC
C	FRONT LEG		2 PCS

HARDWARE LIST

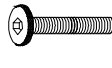
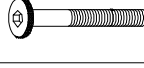
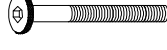
NO.	DESCRIPTION	SKETCH	QTY
1	FLAT WASHER 1/4" x 3/4" DIA.		10 PCS
2	SPRING WASHER 1/4" DIA.		10 PCS
3	ALLEN KEY M4		1 PC
4	SHORT BOLT 1/4" x 1-3/8"		2 PCS
5	MEDIUM BOLT 1/4" x 2-3/8"		4 PCS
6	LONG BOLT 1/4" x 3"		4 PCS

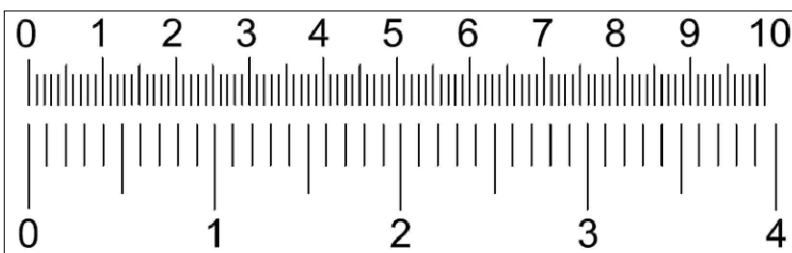

Assembly Instructions

COLLECTION : TRELLIS

ITEM NO : D5030-20 DINING CHAIR
(2 PER CARTON)

STEP 1

Place the chair back (A) on a soft and clean surface. Line up the seat (B) with the chair back (A) and assemble the two pieces together by using Allen Key (3) with hardware 1, 2, and 4. Then assemble the seat (B) with the back legs of the chair back (A) using Allen Key (3) with hardware 1, 2, and 6.

*Attention: DO NOT TIGHTEN THE BOLTS

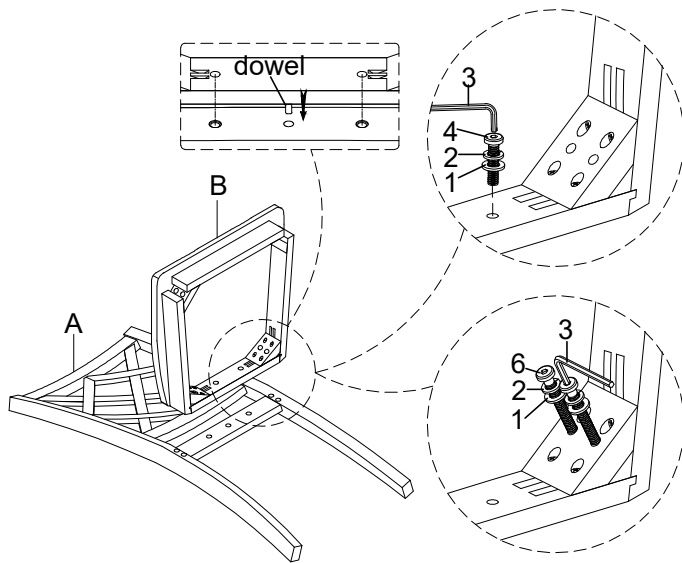

STEP 2

Assemble the front legs (C) with the seat (B) by using Allen Key (3) with hardware 1, 2, and 5.

*Attention: DO NOT TIGHTEN THE BOLTS

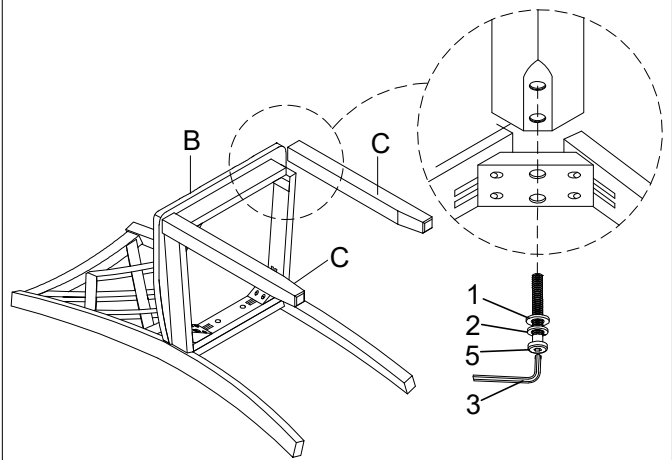

STEP 3

To level the chair, stand the chair up on a flat surface and tighten all the bolts by using Allen Key (3).

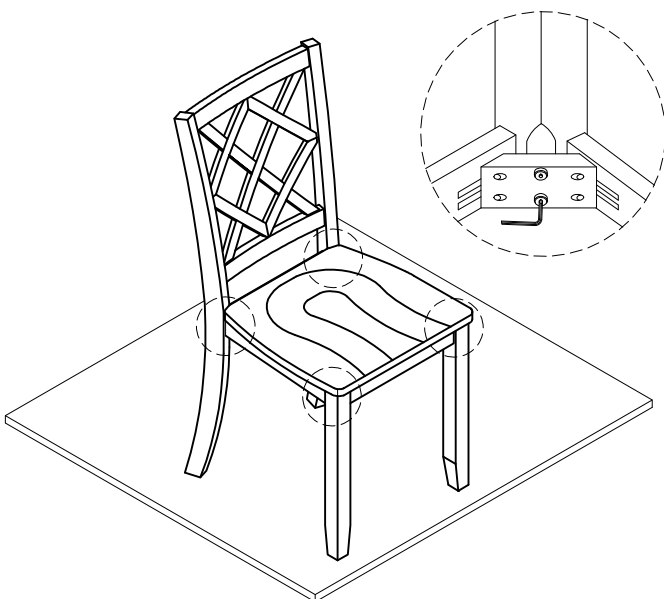

STEP 4

Repeat STEP 1 through STEP 3 to assemble the other chair.

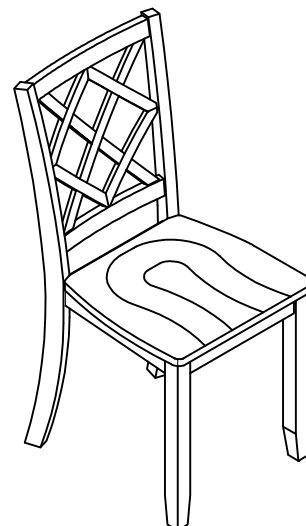

Fully Assembled Chair