







Thank you for purchasing this quality product. Be sure to check all packing materials carefully for small parts, which may have come loose inside the carton during shipment. Identify and count all items and compare with the parts list and/or hardware list shown below.

NO.	PART DESC	SKETCH	Q'TY
A	Table Top		1pc
B	Middle Shelf		1pc
C	Leg		4pcs

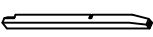
NO.	HARDWARE DESC	SKETCH	Q'TY
1	Lock Washer (Ø5/16 ")		12pcs
2	Flat Washer (Ø5/16 ")		12pcs
3	Long Bolt (Ø5/16 "x65mm)		12pcs
4	Allen key (5mm)		1pc

**NOTES :**

Do not fully tighten any bolts until last step.

To assemble the table, please follow the following steps but do not tighten all bolts:

STEP 1: Install 3 of the table legs first.

STEP 2: Install the table shelf.

STEP 3: Install the last table leg.

STEP 4: Turn the table to the upright position carefully and make sure the table is level, then tighten all bolts.

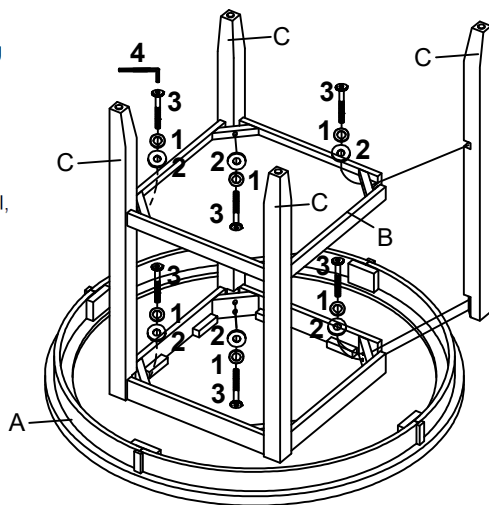

**COMPLETED**

