











ASSEMBLY INSTRUCTIONS

ITEM NO.: D2541-22 BIXBY COUNTER CHAIR

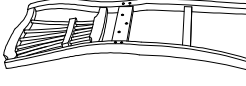
Thank you for purchasing this quality product. Be sure to check all packing materials carefully for small parts, which may have come loose inside the carton during shipment. Identify and count all parts and compare with the part list below.

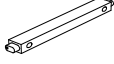
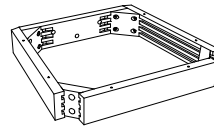
HARDWARE LIST			
NO.	DRAWING	DESCRIPTION	QTY
A		Flat Washer 5/16"	22 pcs
B		Spring Washer 5/16"	22 pcs
C		Nut 5/16"	8 pcs
D		Allen Wrench	1 pc
E		Short Bolt 1/4" x 1 3/4"	6 pcs
F		Long Bolt 1/4" x 3"	8 pcs
G		Wood Screw 5/32" x 1 1/2"	24 pcs

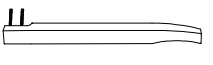
PART LIST		
1	3	5
		
Back Leg (2 pcs)	Cushion Seat (2 pcs)	Front Stretcher (2 pcs)
2	4	6
		
Seat Frame (2 pcs)	Side Stretcher (4 pcs)	Front Leg (4 pcs)

STEP 1

Put the Back Leg (1) and the Seat Frame (2) upside down on the soft and smooth surface. Then insert Long Bolt (F), Short Bolt (E), Spring Washer (B), and Flat Washer (A) into the pre-drilled holes of each corner, by using Allen Wrench (D).

STEP 2

Insert Side Stretcher (4) into the holes of Back Leg (1) with Wood Screw (G) by using Screwdriver (not included). Do not fully tighten screws in this step.

STEP 3

First, insert the Front Stretcher (5) into the holes of the Front Leg (6) by using Wood Screw (G). Attach the Front Leg (6) to the Side Stretcher (4) and the corner of Seat Frame (2). Insert Flat Washer (A), Spring Washer (B), and Nut (C) by using Allen Wrench (D). Tighten all Wood Screw (G) in this step.

STEP 4

Attach the Cushion Seat (3) onto the Seat Frame (2) with Wood Screw (G) by using Screwdriver (not included).

STEP 5

Turn the assembled chair to the upright position carefully. Make sure the chair is level, and then securely tighten all bolts at this stage. Assembly is now completed.

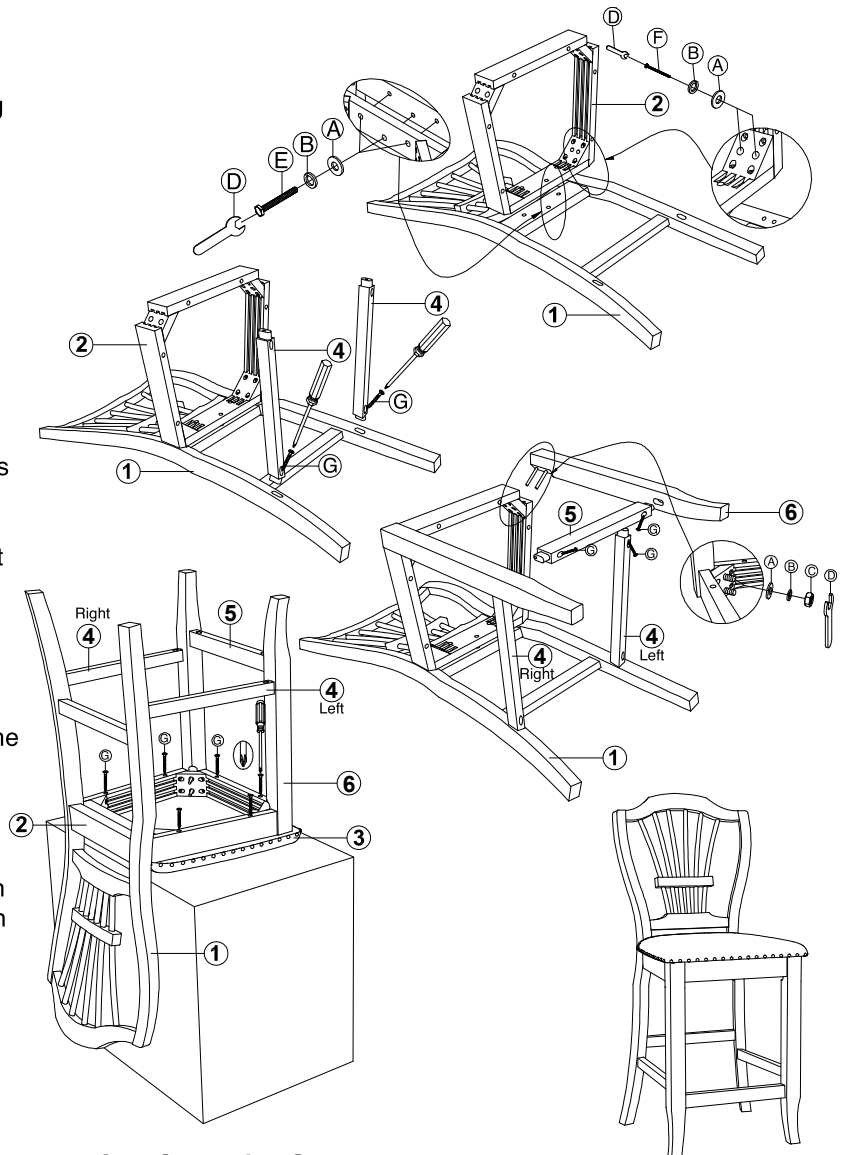

CLEANING INSTRUCTION

Clean the surface with a furniture polish and a soft cloth

MADE IN VIETNAM