













ASSEMBLY INSTRUCTIONS

ITEM NO.: D2541-10 BIXBY DINING TABLE

Thank you for purchasing this quality product. Be sure to check all packing materials carefully for small parts, which may have come loose inside the carton during shipment. Identify and count all parts and compare with the part list below.

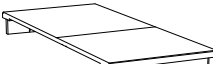
HARDWARE LIST			
NO.	DRAWING	DESCRIPTION	QTY
A		Flat Washer 5/16"	20 pcs
B		Spring Washer 5/16"	20 pcs
C		Allen Bolt 5/16" x 3"	8 pcs
D		Allen Bolt 5/16" x 1 1/2"	4 pcs
E		Allen Bolt 1/4" x 1 3/4"	8 pcs
F		Leveler	4 pcs
G		Wood Dowel Ø10 x 30 mm	4 pcs
H		Allen Key	1 pc

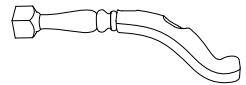
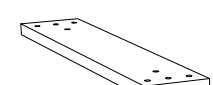
PART LIST		
1  Table Top (1 pc)	3  Lower Panel (1 pc)	5  Table Leaf (1 pc)
2  Wine shelf (1 pc)	4  Table Leg (4 pcs)	6  Middle Panel (2 pcs)

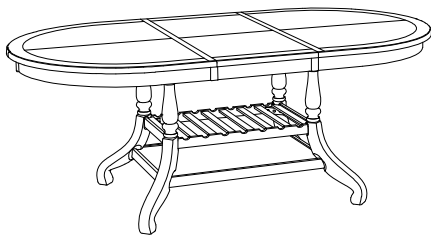

STEP 1

Attach the Wine Shelf (2) to the Table Leg (4) by using Flat Washer (A), Spring Washer (B), Allen Bolt (C), and tighten using Allen Key (H).

STEP 2

Attach the Lower Panel (3) to the Table Leg (4) by using Flat Washer (A), Spring Washer (B), Allen Bolt (C), and tighten using Allen Key (H).

STEP 3

Attach the Middle Panel (6) to the Table Leg (4) by using Flat Washer (A), Spring Washer (B), Allen Bolt (D), and tighten using Allen Key (H).

STEP 4

Insert Wood Dowel (G) on the Table Top (1) rails. Attach the Middle Panel (6) to the Table Top (1) by using Flat Washer (A), Spring Washer (B), Allen Bolt (E), and tighten using Allen Key (H). Attach Leveler (F) into the pre-drilled holes on the bottom of the Table Leg (4).

STEP 5

Turn the table upright. Unlock the latches located underneath the Table Top (1). Pull apart the Table Top (1) at both ends and place the Table Leaf (5) in the center. Push both ends together to close and lock the latches.

Assembly is now completed.

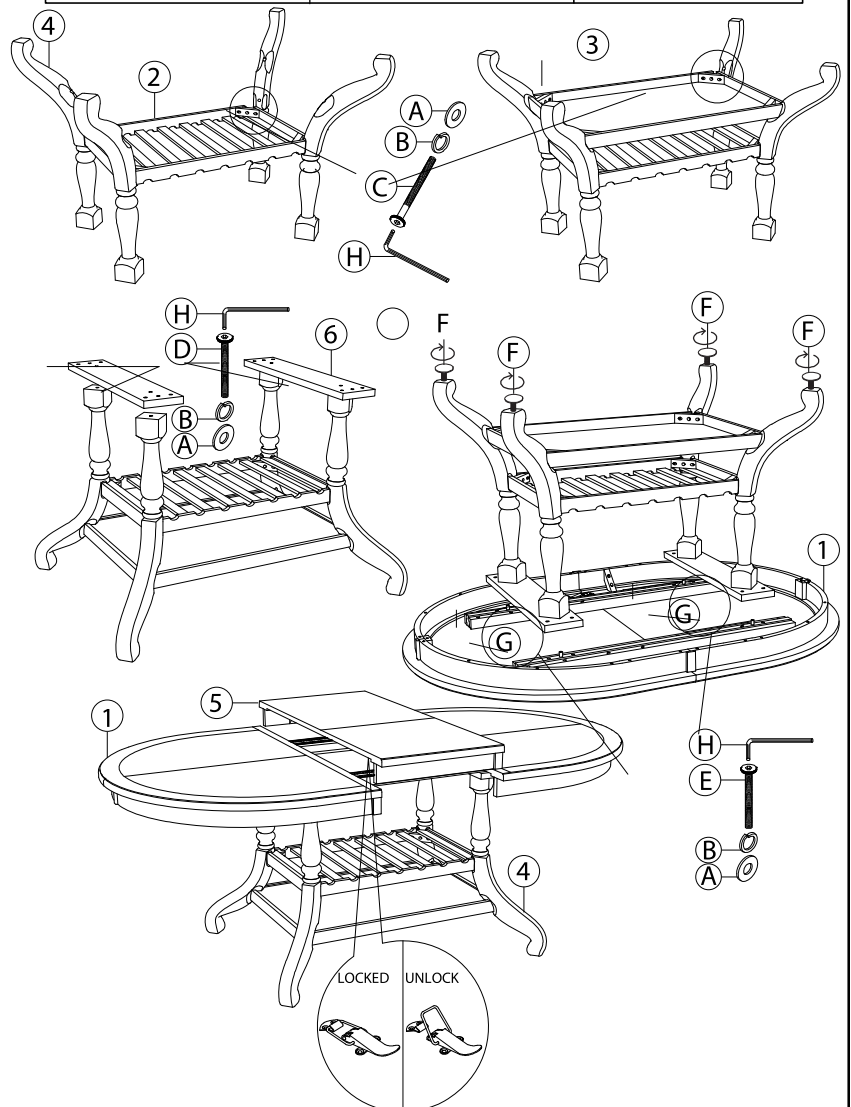

CLEANING INSTRUCTION

Clean the surface with a furniture polish and a soft cloth