

# ASSEMBLY INSTRUCTION

## PASCAL COLLECTION

### MODEL : D1652-10 PASCAL 59" RECTANGLE DINING TABLE





Thank you for purchasing this quality product. Be sure to check all packing materials carefully for small parts, which may have come loose inside the carton during shipment. Identify and count all items and compare with the parts list and/or hardware list shown below.

Please read all instructions carefully. See the hardware and furniture part listing for guidance. Be sure you have all parts listed before beginning assembly. Place all wooden parts on a clean, flat surface to protect the finish from scratches. Follow the diagram to assemble.

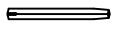
#### CAUTION

1. Do not fully tighten the nuts or bolts until the table is fully assembled.
2. Please tighten by hand, not by a drill. Overtightening will damage threads. Do not overtighten.
3. Keep all hardware out of the reach of children.

PARTS LIST			
ITEM	DESCRIPTION	SKETCH	QTY
1	TOP PANEL		1 PC
2	LEG		4 PCS

HARDWARE LIST			
ITEM	DESCRIPTION	SKETCH	QTY
A	JCBB SCREW M8 x 2-6/8"		8 PCS
B	SPRING WASHER M8 x 1/2"		8 PCS
C	FLAT WASHER M8 x 7/8"		8 PCS
D	M5 ALLEN KEY (2-9/16")		1 PC

#### STEP 1

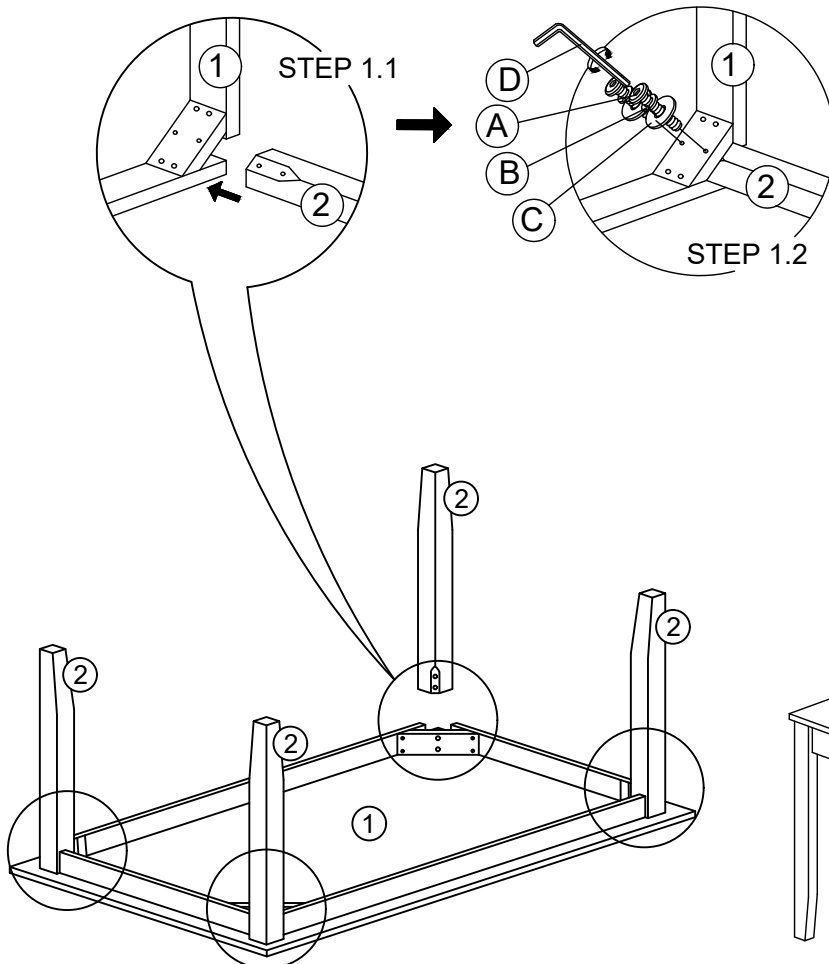

FULLY SET-UP

