



Assembly Instructions





D058B/ W-11: PRAIRIE POINT 47" ROUND DINING TABLE

Thank you for purchasing this quality product. Be sure to check all packing materials carefully for small parts, which may have come loose inside the carton during shipment. Identify and count all items and compare with the PARTS LIST and/or HARDWARE LIST shown below.





Caution: Please read the instructions thoroughly before assembly.

1. We recommend that you assemble this product with the assistance of another person; this will make the assembly easier, and will help eliminate damage to the product or injury to persons during assembly.
2. Please do not over tighten screws or bolts until the assembly is completed.
3. Please put all parts on a non-abrasive floor before assembly, and follow the assembly steps to assemble your newly purchased product correctly and efficiently.

PARTS LIST

NO.	COMPONENT	DRAWING	Q'TY
A	TABLE TOP		1 PC
B	LEG		4 PCS
C	WOODEN BLOCK		4 PCS
D	SHELF		1 PC

HARDWARE LIST

NO.	COMPONENT	DRAWING	Q'TY
1	SHORT BOLT 5/16" x 1-1/2"		24 PCS
2	LONG BOLT 5/16" x 2"		4 PCS
3	LOCK WASHER 5/16" Dia		28 PCS
4	FLAT WASHER 5/16" Dia		28 PCS
5	WRENCH		1 PC

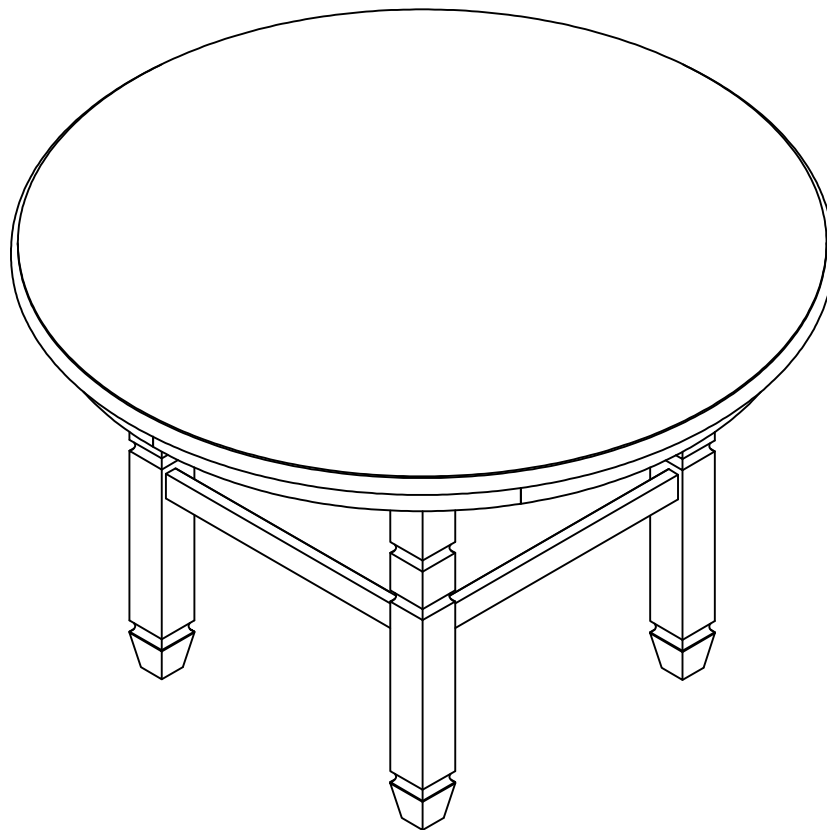

MADE IN VIET NAM

PAGE: 1 OF 2

Assembly Instructions

D058B/ W-11: PRAIRIE POINT 47" ROUND DINING TABLE

STEP 1

Do NOT tighten any bolts before shelf is assembled

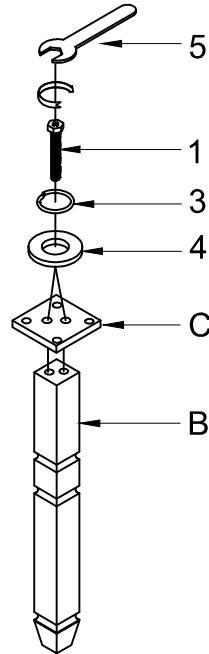

STEP 2

