

Assembly Instructions

VALENTINO 6/6-6/0 K LIGHTED HEADBOARD & FOOTBOARD & SIDE RAIL / BA9698-110 & 120 & 330





VALENTINO 5/0 Q LIGHTED HEADBOARD & FOOTBOARD & SIDE RAIL / BA9698-310 & 320 & 330



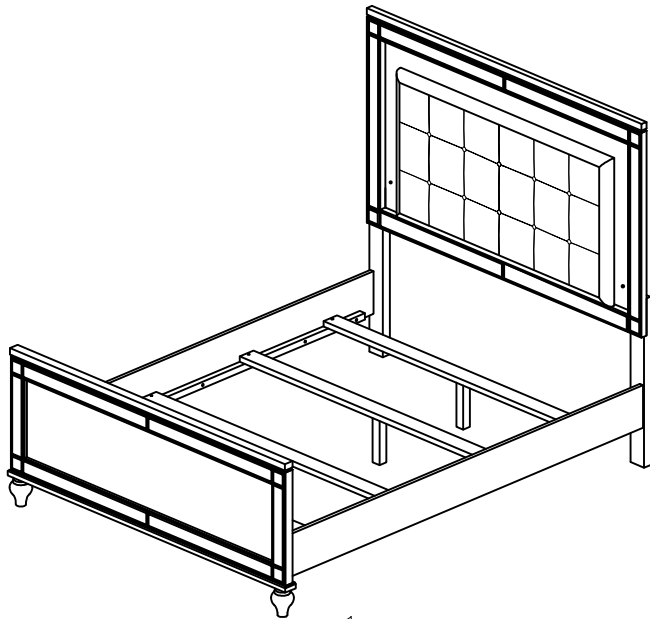

VALENTINO 4/6 F LIGHTED HEADBOARD & FOOTBOARD & SIDE RAIL / BA9698-410 & 420 & 530

VALENTINO 3/3 T LIGHTED HEADBOARD & FOOTBOARD & SIDE RAIL / BA9698-510 & 520 & 530

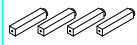
Thank you for purchasing this quality product. Be sure to check all packing materials carefully for small parts, which may have come loose inside the carton during shipment. Identify and count all items and compare with the parts list and hardware list shown below.



| PARTS LIST | | | |
|------------|-------------|---|-------|
| NO | DESCRIPTION | SKETCH | QTY |
| 1 | HEADBOARD |  | 1 PC |
| 2 | FOOTBOARD |  | 1 PC |
| 3 | SIDE RAIL |  | 2 PCS |
| 4 | SLAT |  | 4 PCS |
| 5 | SUPPORT |  | 4 PCS |

| HARDWARE LIST | | | |
|---------------|------------------------|---|-------|
| NO | DESCRIPTION | SKETCH | QTY |
| A | JCBC BOLT - M6 x 40mm |  | 4 PCS |
| B | SPRING WASHER - M6 |  | 4 PCS |
| C | ALLEN KEY - M4 |  | 1 PC |
| D | CSK SCREW - M4 x 32 mm |  | 8 PCS |

