

Assembly Instructions



ITEM: B909 - 070 BALBOA LIFT TOP CHEST-WALNUT

Thank you for purchasing this quality product. Be sure to check all packing materials carefully for small parts, which may have come loose inside the carton during shipment. Identify and count all items and compare with the PARTS LIST and/or HARDWARE LIST shown below.

Caution: Please read the instructions thoroughly before assembly.

1. We recommend that you assemble this product with the assistance of another person; this will make the assembly easier, and will help eliminate damage to the product or injury to persons during assembly.
2. Please do not over tighten screws or bolts until the assembly is completed.
3. Please put all parts on a non-abrasive floor before assembly, and follow the assembly steps to assemble your newly purchased product correctly and efficiently.

PARTS LIST

NO:	COMPONENT	SKETCH	Q'TY
A	CHEST		1 PC
B	BUN FEET		4 PCS
C	ANTI-TIPPING KIT		1 SET

Place the chest (A) back down on a clean soft flat surface such as a blanket and ensure the surface is clean of any objects that could scratch or damage the chest. Then assemble four leg (B) to the chest (A).

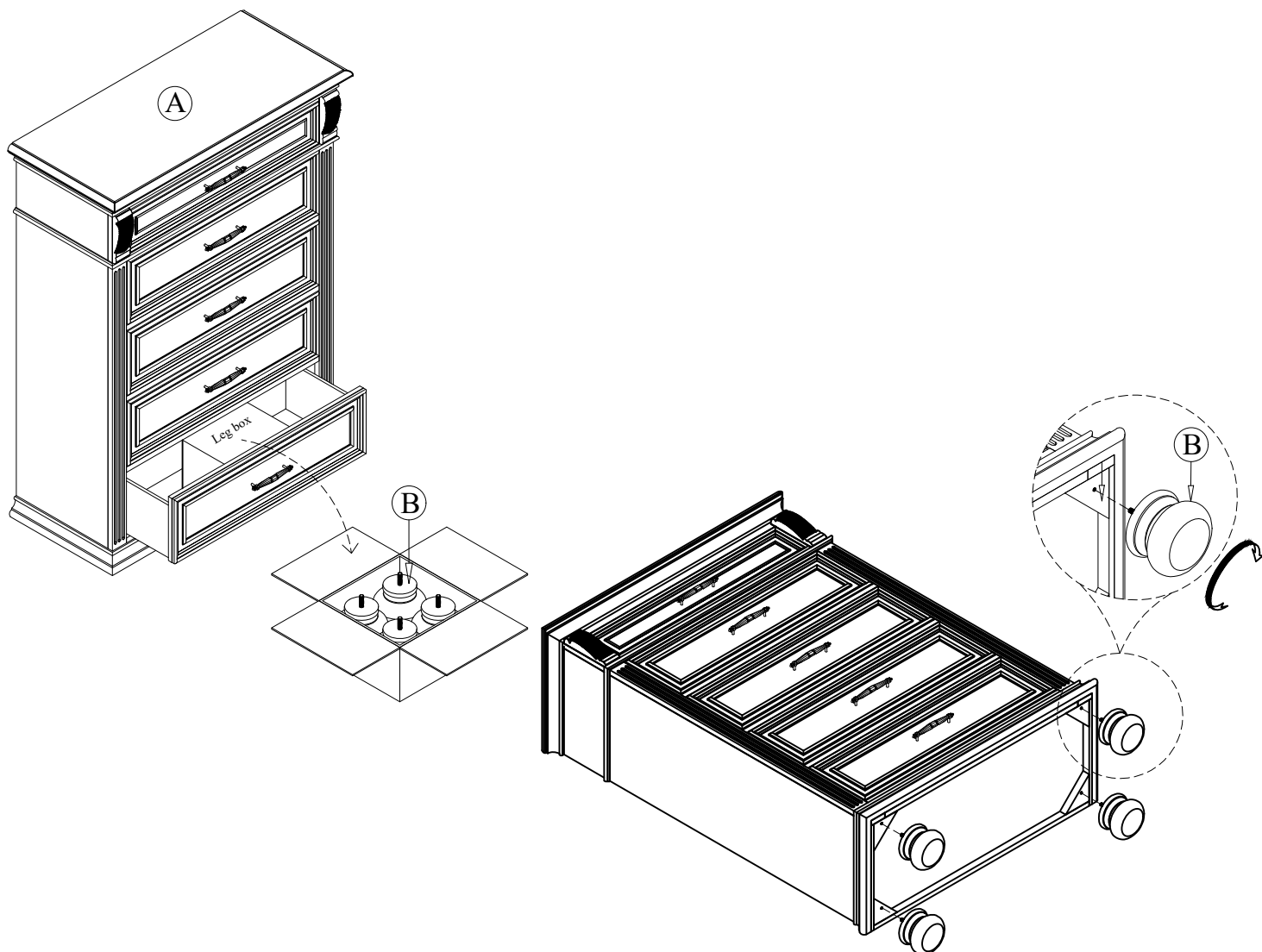



Assembly Instructions



ITEM: B909 - 070 BALBOA LIFT TOP CHEST-WALNUT

Thank you for purchasing this quality product. Be sure to check all packing materials carefully for small parts, which may have come loose inside the carton during shipment. Identify and count all items and compare with the PARTS LIST and/or HARDWARE LIST shown below.

Caution: Please read the instructions thoroughly before assembly.

1. We recommend that you assemble this product with the assistance of another person; this will make the assembly easier, and will help eliminate damage to the product or injury to persons during assembly.
2. Please do not over tighten screws or bolts until the assembly is completed.
3. Please put all parts on a non-abrasive floor before assembly, and follow the assembly steps to assemble your newly purchased product correctly and efficiently.

PARTS LIST

NO:	COMPONENT	SKETCH	Q'TY
A	CHEST		1 PC
B	BUN FEET		4 PCS
C	ANTI-TIPPING KIT		1 SET

Installing anti-tipping kit: Following the installation instructions that come in the tip-restraint package. Assemble is complete.

