











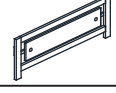

Thank you for purchasing this quality product. Be sure to check all packing materials carefully for small parts, which may have come loose inside the carton during shipment. Identify and count all items and compare with the parts list and/or hardware list shown below.

PARTS LIST			
ITEM	DESCRIPTION	SKETCH	QTY
1	HEADBOARD		1PC
2	HEADBOARD LEG (RSF)		1PC
3	HEADBOARD LEG (LSF)		1PC
4	FOOTBOARD		1PC
5	SIDE RAIL (L/R)		2PCS
6	SLAT		4PCS

HARDWARE LIST			
ITEM	DESCRIPTION	SKETCH	QTY
A	JCBC SCREW - M8 x 25/32"		8PCS
B	JCBC SCREW - M6 x 19/32"		6PCS
C	JCBC SCREW - M6 x 63/64"		8PCS
D	SPRING WASHER - M6 x 15/32"		4PCS
E	FLAT WASHER - M6 x 3/4"		4PCS
F	M4 ALLEN KEY (3 15/16")		1PC
G	M5 ALLEN KEY (2 9/16")		1PC

BACK VIEW

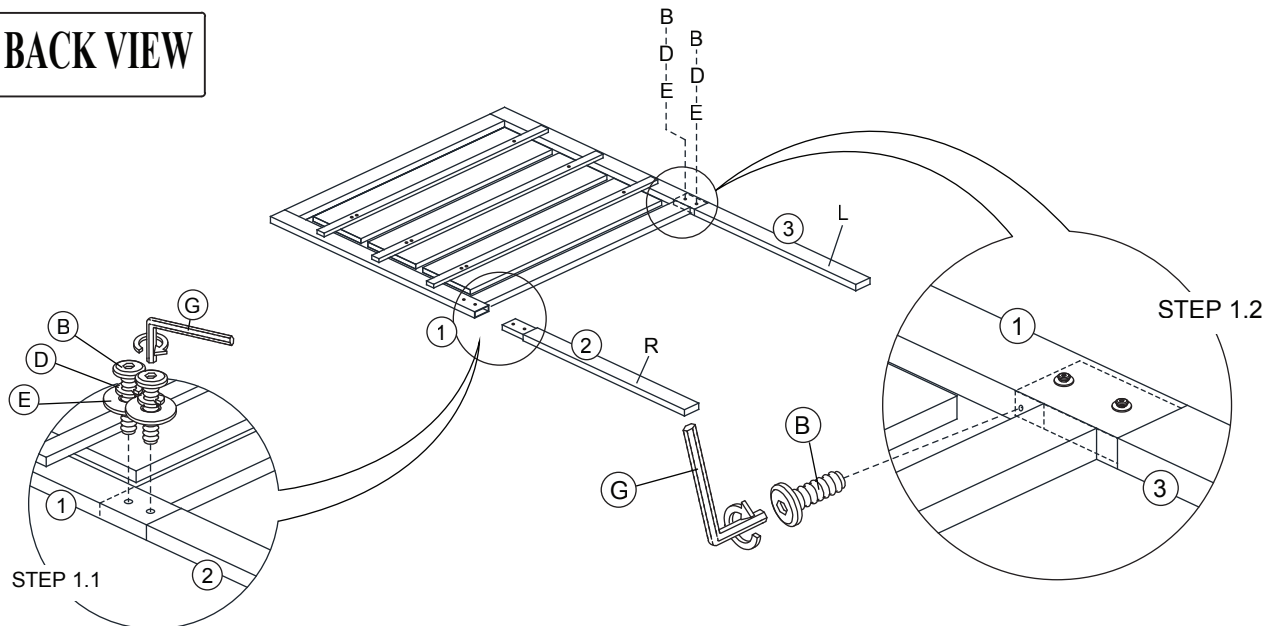

IMPORTANT NOTE :

- * Place all wooden parts on a clean and smooth surface such as a rug or carpet to avoid the parts from being scratched.
- * Check to be sure that you have all parts and hardware.
- * Remove all wrapping materials, including staples & packing straps before you start to assemble.
- * Do not tighten all screws/bolts until all completely assembled.
- * Keep all hardware parts out of reach of children.

ASSEMBLY INSTRUCTIONS
ELK RIVER TWIN BED

B5533-515 ELK RIVER 3/3 T HB, FB & SLATS
 B5533-535 ELK RIVER 4/6-3/3 F/T SIDE RAILS

Thank you for purchasing this quality product. Be sure to check all packing materials carefully for small parts, which may have come loose inside the carton during shipment. Identify and count all items and compare with the parts list and/or hardware list shown below.

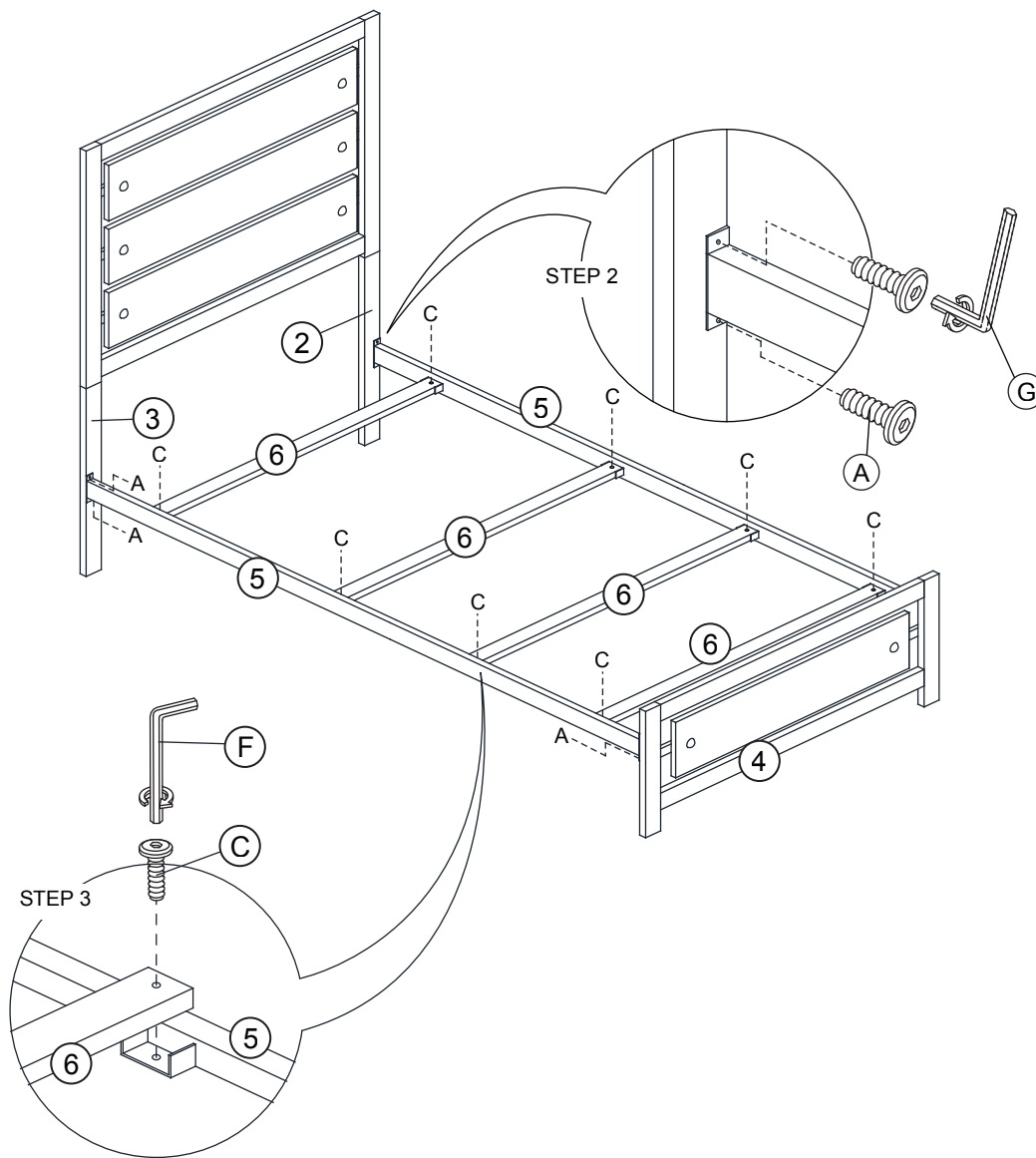

IMPORTANT NOTE :

- * Place all wooden parts on a clean and smooth surface such as a rug or carpet to avoid the parts from being scratched.
- * Check to be sure that you have all parts and hardware.
- * Remove all wrapping materials, including staples & packing straps before you start to assemble.
- * Do not tighten all screws/bolts until all completely assembled.
- * Keep all hardware parts out of reach of children.