

# Assembly Instructions









ITEM: B1731-110 – ANASTASIA 6/6-6/0 EK/WK HEADBOARD  
 B1731-120 – ANASTASIA 6/6-6/0 EK/WK FOOTBOARD & SLATS  
 B1731-330 - ANASTASIA 5/0 -6/6 Q/EK SIDE RAILS

Thank you for purchasing this quality product. Be sure to check all packing materials carefully for small parts, which may have come loose inside the carton during shipment. Identify and count all items and compare with the PARTS LIST and/or HARDWARE LIST shown below.

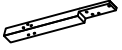





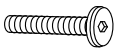

**Caution:** Please read the instructions thoroughly before assembly.

1. We recommend that you assemble this product with the assistance of another person; this will make the assembly easier, and will help eliminate damage to the product or injury to persons during assembly.
2. Please do not over tighten screws or bolts until the assembly is completed.
3. Please put all parts on a non-abrasive floor before assembly, and follow the assembly steps to assemble your newly purchased product correctly and efficiently.

## PARTS LIST

NO:	COMPONENT	SKETCH	Q'TY
A	HEADBOARD		1PC
B1	HEADBOARD LEFT LEG		1PCS
B2	HEADBOARD RIGHT LEG		1PCS
C	HB BOTTOMRAIL		1PC
D	FOOTBOARD		1PC
E	SIDE RAIL		2PCS
F	SLATS		5PCS
G	SUPPORT LEG		10PCS

## HARDWARE LIST

NO:	COMPONENT	SKETCH	Q'TY
1	BOLT 5/16" x 1-3/4"		8PCS
2	LOCK WASHER 5/16"		8PCS
3	FLAT WASHER 5/16" (19 mm)		8PCS
4	ALLEN KEY		1PC
5	OPEN WRENCH		1PC
6	HEX NUT 5/16" Dia		8PC
7	U WASHER 5/16" DIA		8PC
8	THREAD BOLT 5/16" x 3-1/2"		8PC
9	SCREW: # 8 X 1-1/4"		10PCS

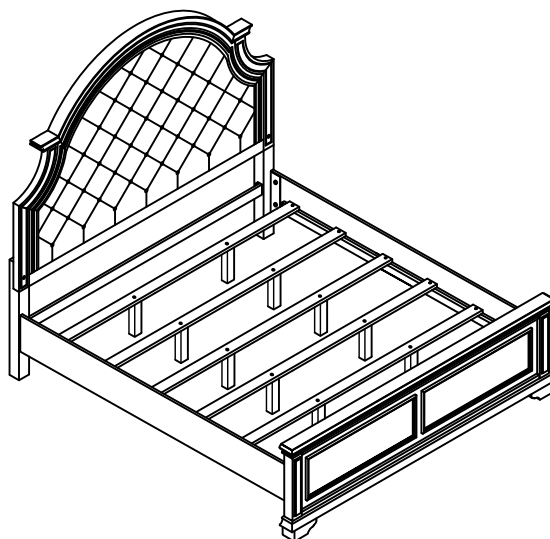

# Assembly Instructions

ITEM: B1731-110 – ANASTASIA 6/6-6/0 EK/WK HEADBOARD  
 B1731-120 – ANASTASIA 6/6-6/0 EK/WK FOOTBOARD & SLATS  
 B1731-330 - ANASTASIA 5/0 -6/6 Q/EK SIDE RAILS

## STEP1

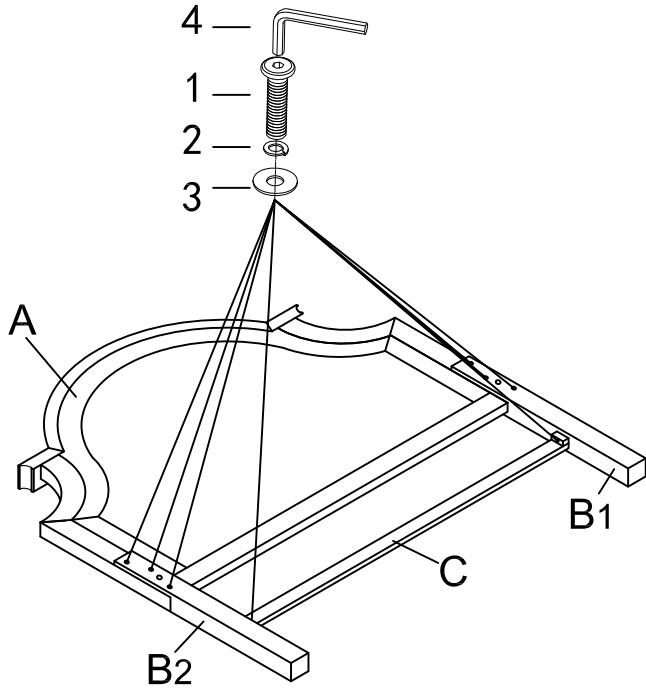

## STEP2

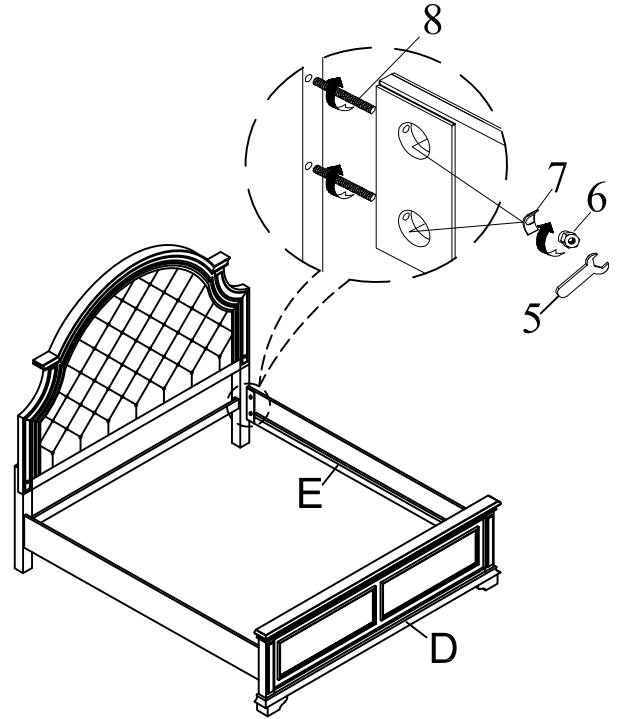

## STEP3

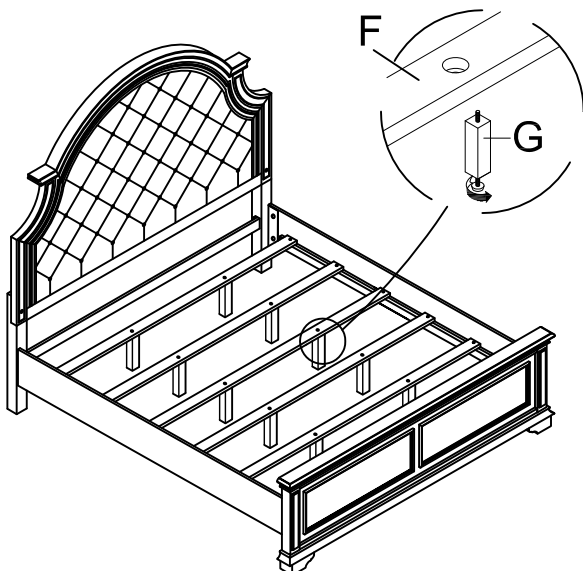

## STEP4

