

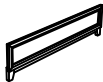





# ASSEMBLY INSTRUCTIONS







**B1655-315 OBSIDIAN 5/0 Q HEADBOARD, FOOTBOARD & SLATS**  
**B1655-335 OBSIDIAN 5/0-6/6 Q/EK SIDE RAILS**

Thank you for purchasing this quality product. Be sure to check all packing materials carefully for small parts, which may have come loose inside the carton during shipment. Identify and count all items and compare with the parts list and/or hardware list shown.

## PARTS LIST

NO	COMPONENT	DRAWING	QTY
A	Headboard		1 pc
B	Footboard		1 pc
C	Headboard Right Side Facing (RSF) Leg		1 pc
D	Headboard Left Side Facing (LSF) Leg		1 pc
E	Slat		4 pcs
F	Slat Support Leg		4 pcs
G	Side Rail		2 pcs
H	Headboard Stretcher		1 pc

## HARDWARE LIST

NO	COMPONENT	DRAWING	QTY
1	JCBC M6 x 1 3/16" Blk		6 pcs
2	Spring Washer 1/4" Blk		6 pcs
3	Flat Washer 1/4"IDx4/8"OD Blk		6 pcs
4	Allen Key M4 x 2 9/16" Blk		1 pc
5	Allen Key M5 x 2 9/16" Blk		1 pc
6	Flat Head Chipboard Screw M4 x 1 2/8" Rbw		12 pcs

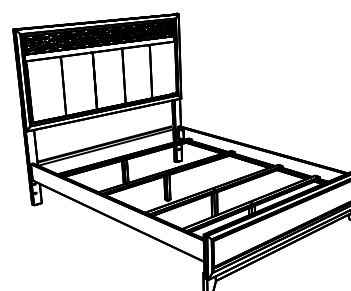

**STEP 1 :** Attach Head Board Leg ( C & D ) to Head Board ( A ) as shown using JCBC BOLT ( 1 ) with Spring Washer ( 2 ), Flat washer ( 3 ) and securing with Allen Key ( 4 ).

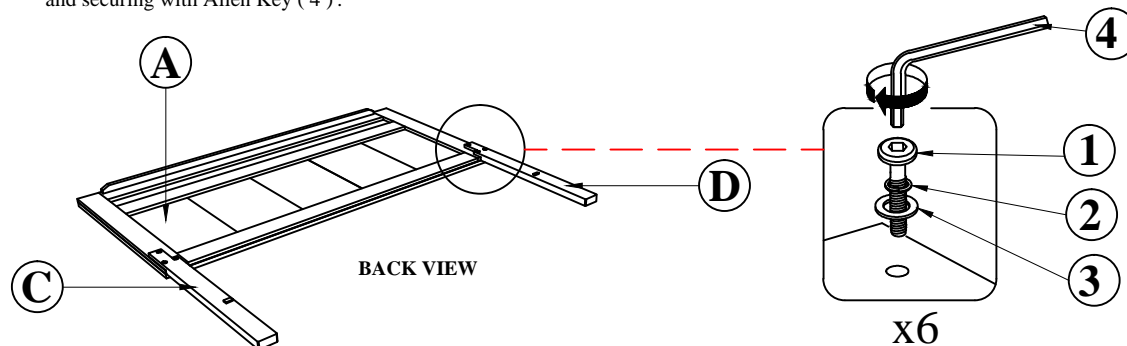

**STEP 2 :** Assemble Headboard Stretcher (H) to Headboard Legs (C & D) by using a screwdriver with Csk Screw (6).

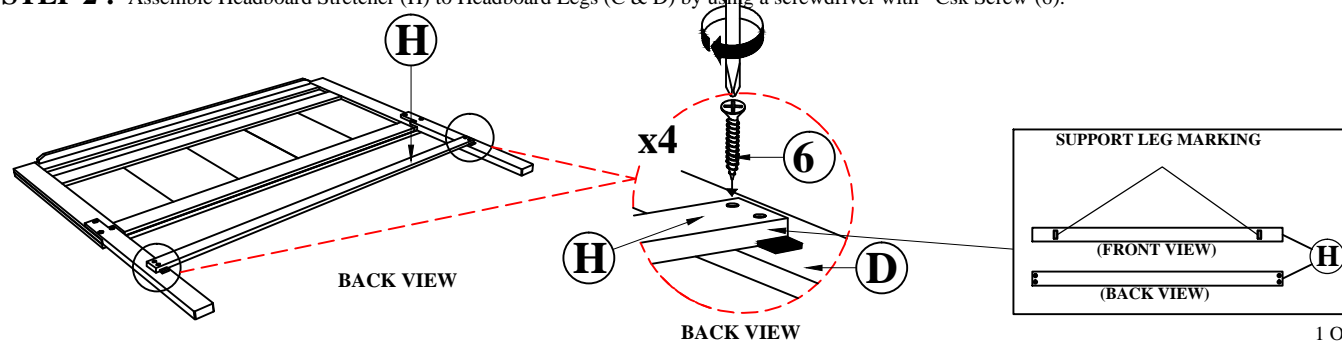

**STEP 3 :** Hook side rail (G) to Headboard legs (C & D) and push it down to fit. Repeat with the other end of rail to hook onto Footboard (B). Tighten the 4 corners with Allen Key (5)

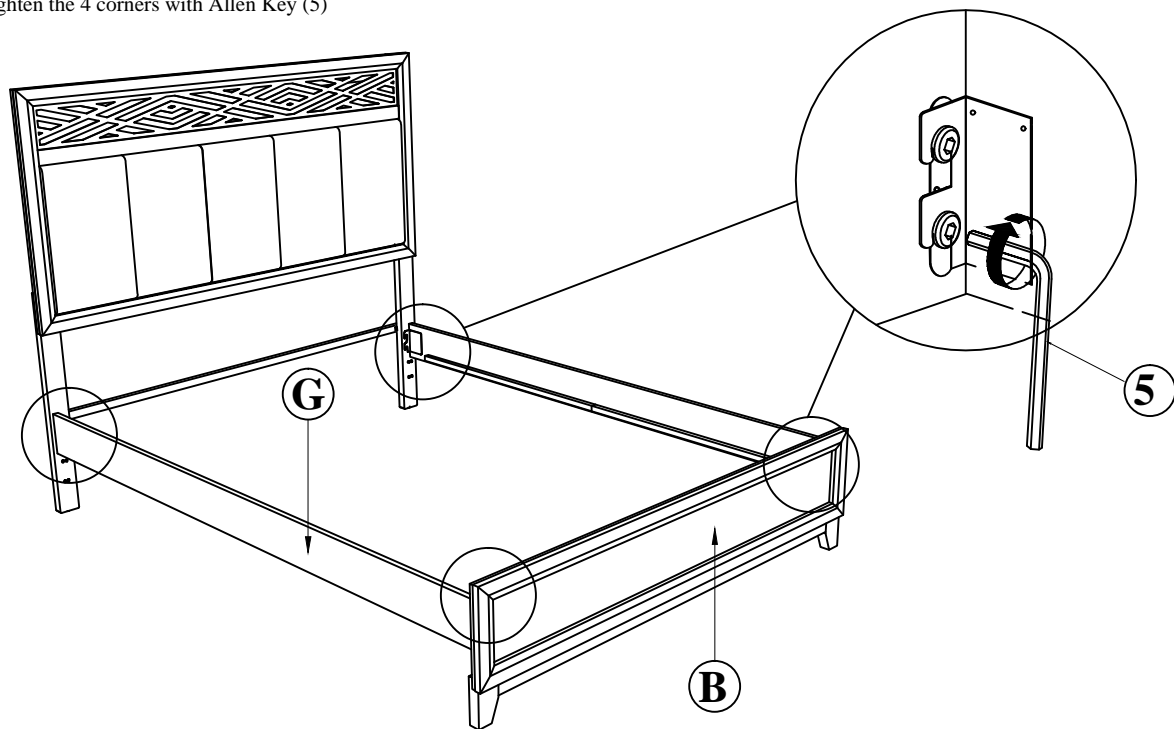

**STEP 4 :** Install the Slat support legs (F) to the Slats (E). Assemble the slats (E) to the side rails (G) by using a screwdriver with hardware (6).  
 (Note: THE SET UP MUST BE DONE AT THE DESIGNATED LOCATIONS FOR THE BED TO BE STABLE)

**STEP 4.1 :**

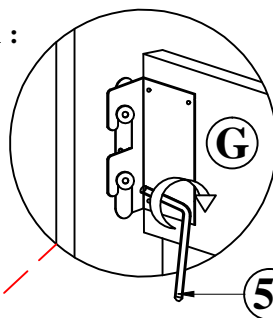

**STEP 4.4 :**

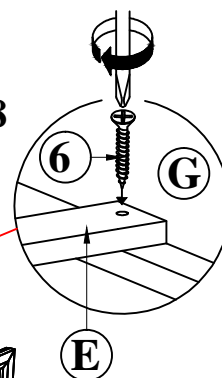

**STEP 4.2 :**

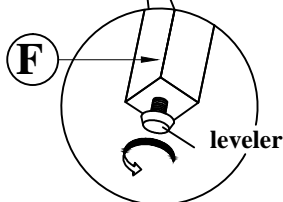
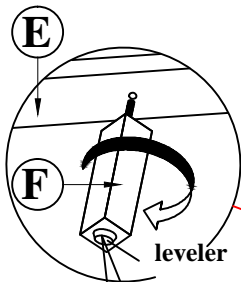

**STEP 4.3 :**

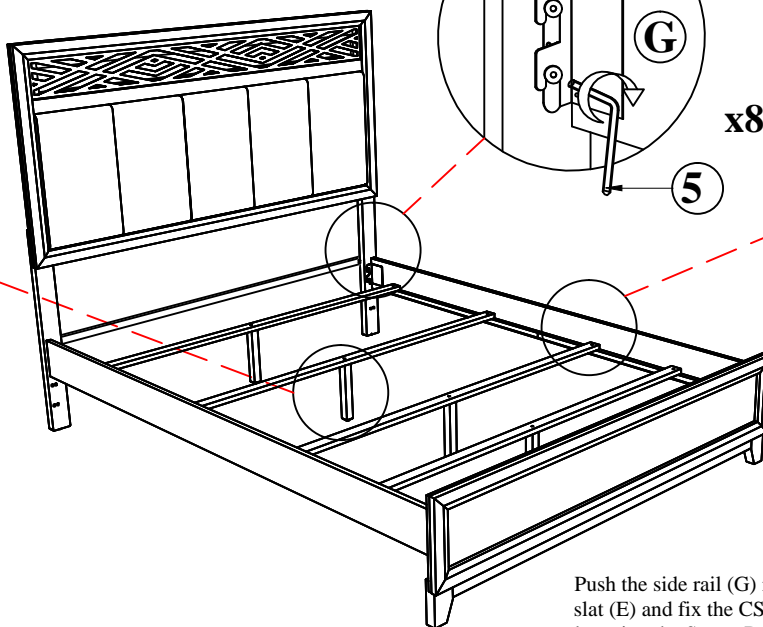

Push the side rail (G) meet with wooden slat (E) and fix the CSK screw (6) by using the Screw Driver (NOT PROVIDED).