









# ASSEMBLY INSTRUCTIONS

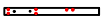
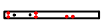

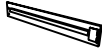

B1564-300 PISCES 5/0 Q PANEL BED-HB/FB/RAILS

Thank you for purchasing this quality product. Be sure to check all packing materials carefully for small parts, which may have come loose inside the carton during shipment. Identify and count all items and compare with the parts list and/or hardware list shown.

## PARTS LIST

No	ITEM	Qty
A	Headboard 	1 pc
B	Footboard 	1 pc
C	Headboard Leg LSF 	1 pc
D	Headboard Leg RSF 	1 pc
E	Bed Roll-Out Slats 	2 sets
F	Bed Slats Support 	4 pcs
G	Side Rail Left 	2 pcs
H	Side Rail Right 	2 pcs
I	Center Slat 	1 pc
J	Side Rail Leg 	2 pcs

## HARDWARE LIST

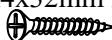
No	ITEM	Qty
1	JCBC M6 x 30mm 	12 pcs
2	JCBC M6 x 50mm 	4 pcs
3	Flat Washer 1/4"ID x 19mmOD Blk 	12 pcs
4	ALLEN KEY m4x65mm Blk (FOR HB LEG) 	1 pc
5	ALLEN KEY m5x65mm Blk (FOR SIDE RAIL) 	1 pc
6	Flat Head Chipboard Screw m4x32mm Rbw 	32 pcs

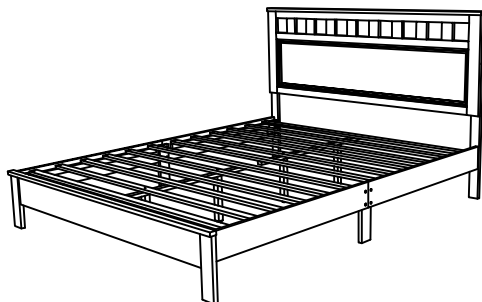

**STEP 1.1 :** Attach Head Board Leg ( C,D ) to Head Board ( A ) as shown using JCBC BOLT( 1 ) with Flat washer (3)and securing with ALLEN KEY ( 4 ).

**STEP 1.2 :** Fix the other holes with Csk Screw (6) as shown.

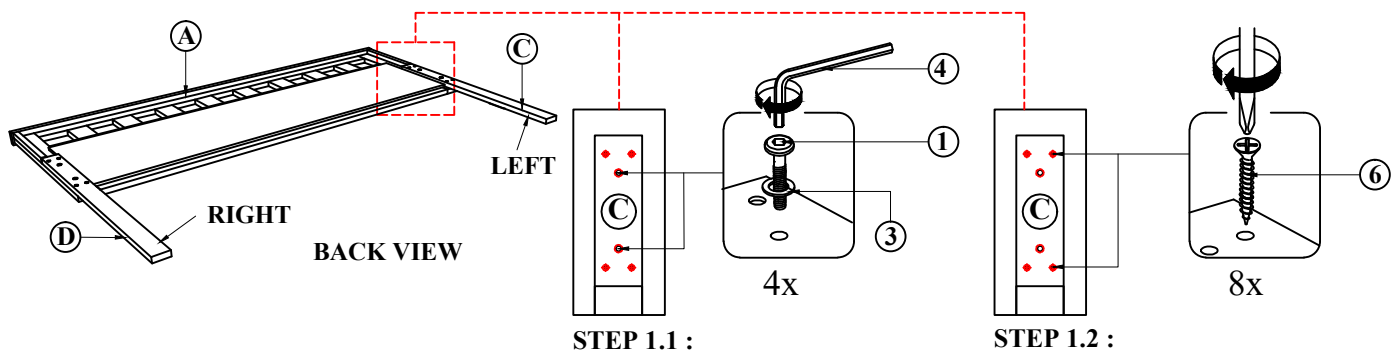

**STEP 2.1 :** Attach Side Rail ( G ) & ( H ) to the Side Rail Leg ( J ) as shown using JCBC BOLT( 1 )with Flat washer (3)and securing with ALLEN KEY ( 4 ) by outside side rail (G) & (H) .

**STEP 2.2 :** Loosen JCBB Bolt at Headboard & Footboard Leg using Allen Key (5) (Do not tighten them before Hook SET-UPSIDE RAIL TO HEAD BOARD (A) closely and push down to fit and tighten them accordingly.

Repeat step 2.2 with other end of rail to hook onto FOOTBOARD (B).

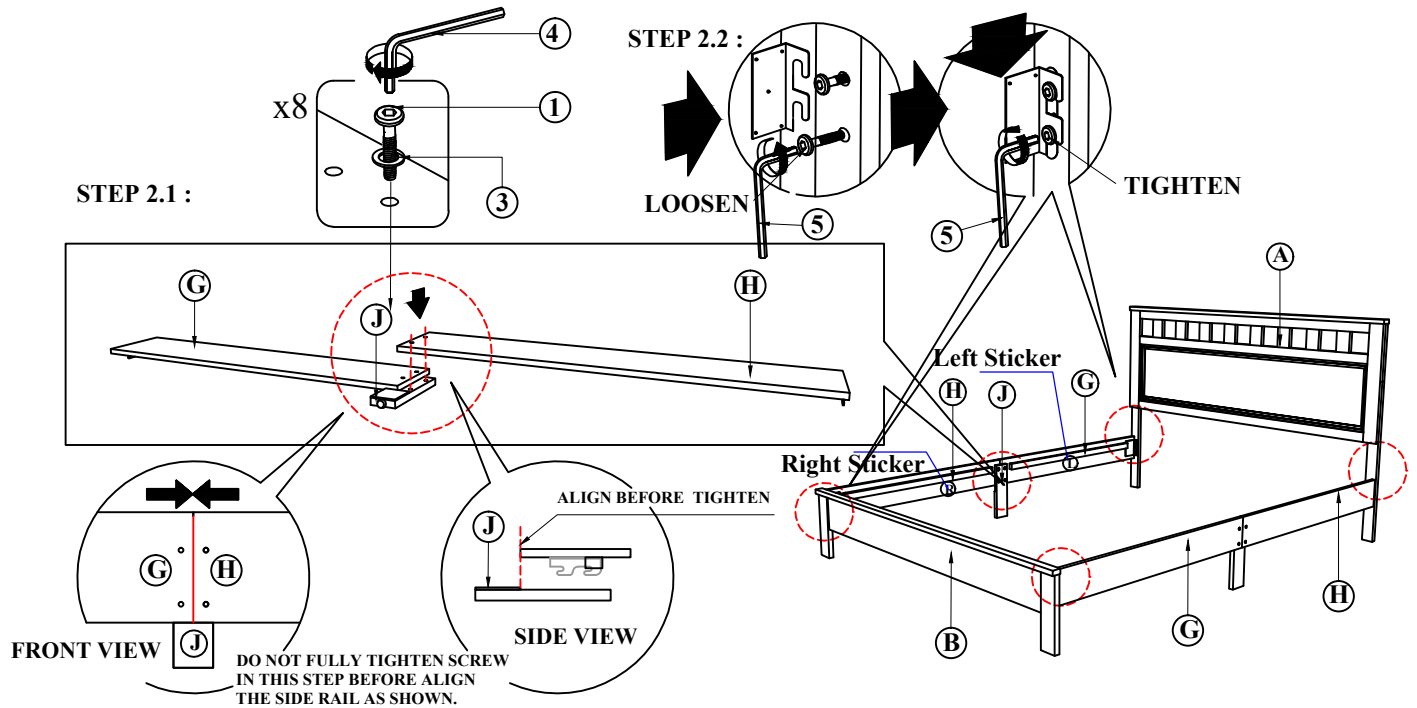

**STEP 3 :** Fix the Bed Slat Support ( F ), to Bed Slat ( E ) and Center slats ( I ) tighten with JCBC Bolt ( 2 ) as shown . Install the bed slat ( E ) to side rail ( G ) & ( H ) and tighten with Csk Screw ( 6 ) as per diagram shown. (NOTE: THE SETUP MUST DONE AT THE DECIDED LOCATION FOR THE BED TO OBTAIN PERFECT STABILITY)

Repeat step 3 for other set of slats assembly.

