

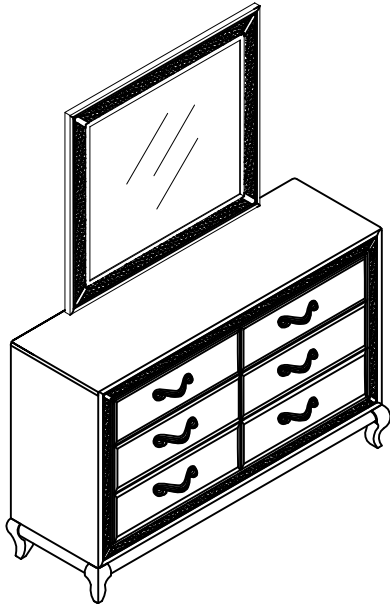



Assembly Instructions





PARK IMPERIAL DRESSER / B0931B/P/W-050

PARK IMPERIAL MIRROR / B0931B/P/W-060

Thank you for purchasing this quality product. Be sure to check all packing materials carefully for small parts, which may have come loose inside the carton during shipment. Identify and count all items and compare with the parts list and hardware list shown below.

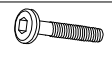

PARTS LIST			
NO	DESCRIPTION	SKETCH	QTY
1	DRESSER		1 PC
2	MIRROR		1 PC
3	MIRROR SUPPORT		2 PCS

HARDWARE LIST			
NO	DESCRIPTION	SKETCH	QTY
A	JCBC BOLT - M6 x 35mm		8 PCS
B	SPRING WASHER - M6		8 PCS
C	FLAT WASHER - M6		8 PCS
D	ALLEN KEY - M4		1 PC

COMPLETE ASSEMBLY

PLACE WOOD PARTS ON A
CLEAN NON-ABRASIVE SURFACE

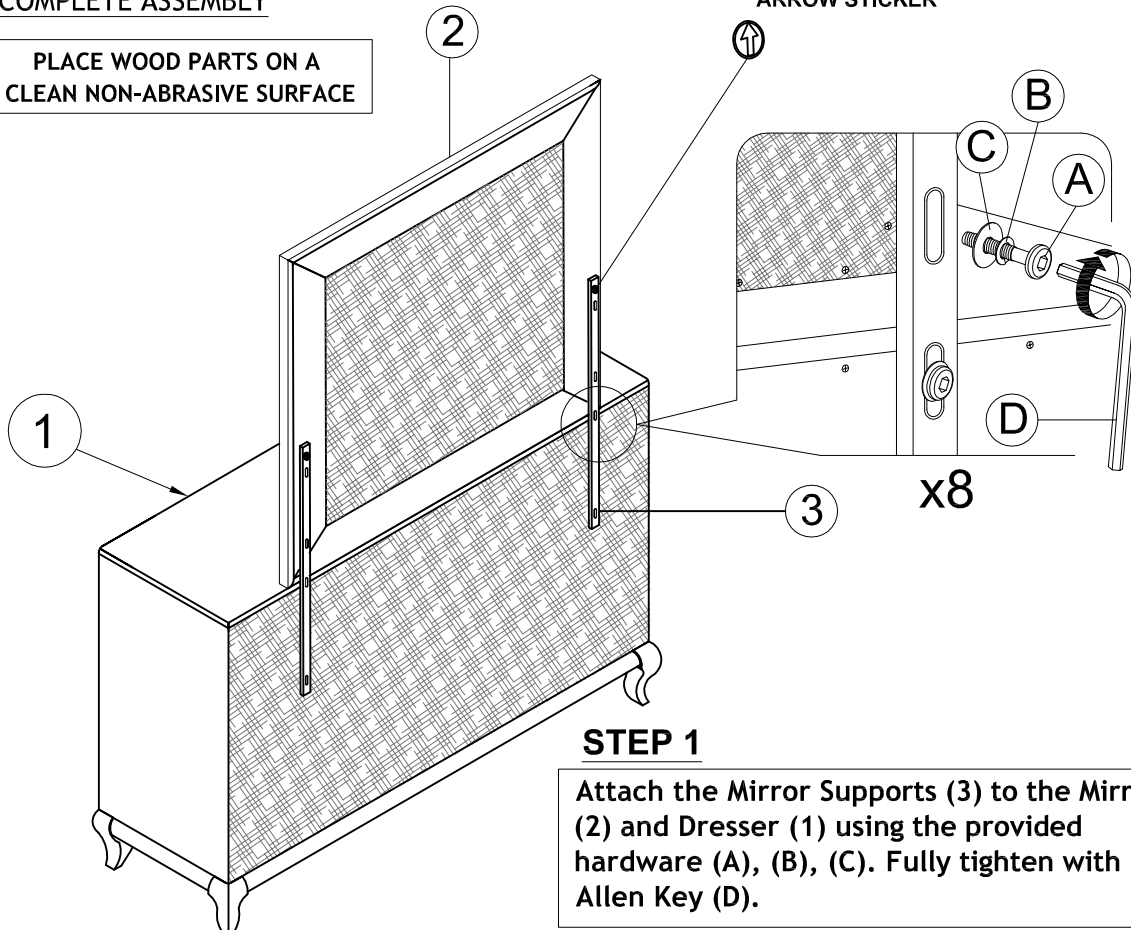

STEP 1

Attach the Mirror Supports (3) to the Mirror (2) and Dresser (1) using the provided hardware (A), (B), (C). Fully tighten with Allen Key (D).