

ASSEMBLY INSTRUCTIONS

Oliver Bed- K

meridian.
furniture

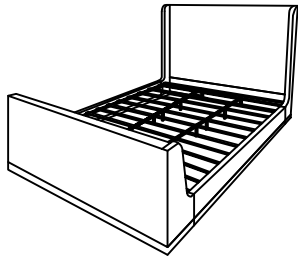

+ Do Not Use
Power Tools



+ Suggested
Adults

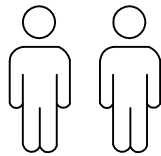

NOTE: For questions about parts or assembly please email support@meridianfurnitureusa.com or call us at 718-758-4455.

- 1 Read instructions cover to cover.
- 2 Save all packaging until assembly is completed.

1 IMPORTANT SAFETY INFORMATION

Do not assemble the product if any of the following parts arrived damaged:

Part #1 -HeadBoard Part #7 -Center leg
Part #2 -FootBoard
Part #3 -Wood strip for Side rail
Part #4 -Middle support rail of slats
Part #5 -Side rail Part #8 -Wood Block on
Part #6 -Slats Headboard &Footboard

Do not assemble if any of the following Hardware parts are missing:

Part#B,E,H -Bolt Part#D,I -Lock washer
Part #A -Allen Key Part # G -Metal bracket
Part# C,I-Flat washer Part# F-screw

2 IMPORTANT ASSEMBLY INFORMATION

Assembly Step If loosening persists, please make sure to tighten all the bolts periodically, or use a thread locker adhesive.

+ Parts Included

① HeadBoard
(1 pc)



② FootBoard
(1 pcs)



③ Wood strip for
Side rail
(2 pcs)



④ Middle support
rail of slats
(2 pcs)



⑤ Side rail
(2 pcs)



⑥ Slats
(13 pcs)



⑦ Center leg
(8 pcs)



⑧ Wood Block on
Headboard &Footboard
(4 pcs)



+ Hardware Included

A Ø5/16"
(1 pc)



B Ø5/16"*3/4"
(24 pcs)



C Ø5/16"
(36 pcs)



D Ø5/16"*3/4"
(36 pcs)



E Ø1/4"*2 1/2"
(12 pcs)



F M6*35mm
(30 pcs)



G Metal bracket
(4 pcs)



H Ø5/16"*2"
(12 pcs)



I Ø1/4"
(12 pcs)



J Ø1/4"
(12 pcs)



ASSEMBLY INSTRUCTIONS

Oliver Bed- K

meridian.
furniture

- 1** Step 1: Attach Metal Bracket (G) to side rail (#5), Headboard (#1) and Footboard (#2) with Bolt (B), Lock washer (D) and Flat washer (C). Tighten with Allen Key (A).

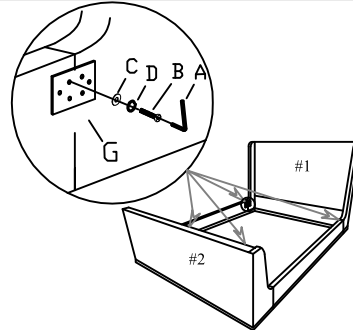

- 2** Step 2: Attach Wood strip for Side rail (#3) to Side Rail (#5), Headboard (#1), and Footboard (#2) with Bolt (H), Lock washer (D) and Flat Washer (C). Tighten with Allen Key (A).

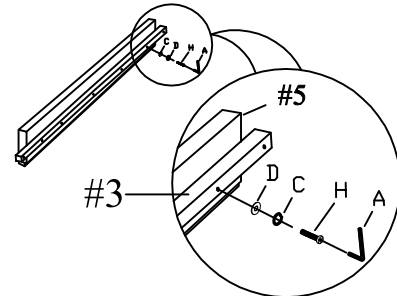

- 3** Step 3: Attach Wood block (#8) to Headboard (#1) and Footboard (#2) with Bolt (E), Lock washer (J) and Flat Washer (I). Tighten with Allen Key (A)

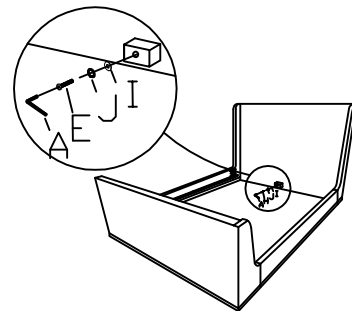

- 4** Step 4: Attach Middle Support Rail (#4) to Headboard (#1) and Footboard (#2) with Screw (F).

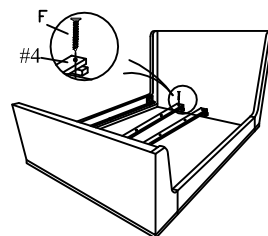

NOTE: For questions about parts or assembly please email support@meridianfurnitureusa.com or call us at 718-758-4455

www.MeridianFurnitureUSA.com | support@meridianfurnitureusa.com

ASSEMBLY INSTRUCTIONS

Oliver Bed- K

meridian.
furniture

- 5** Step 5: Attach Center Leg (#7) TO Middle support rail (#4) and Slats (#6) with Bolt (E), Lock washer (J) and Flat washer (I). Tighten with Allen Key (A).

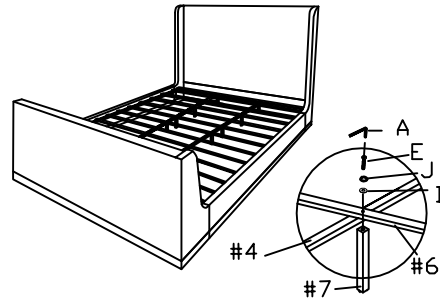

- 6** Step 6: Attach Slats (#6) to Side rail (#5) with Screw (F).

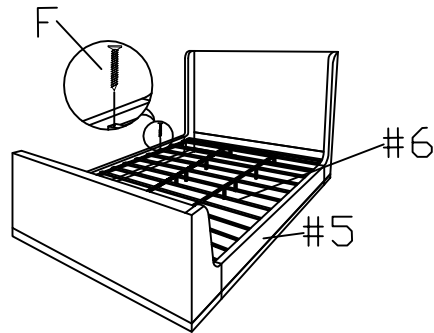

- 7** Step 7: Assembly Complete.

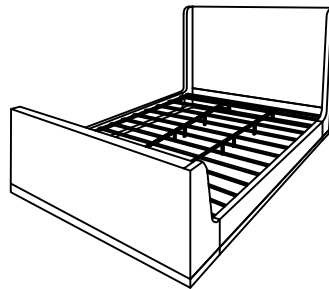

NOTE: For questions about parts or assembly please email support@meridianfurnitureusa.com or call us at 718-758-4455

www.MeridianFurnitureUSA.com | support@meridianfurnitureusa.com