

ASSEMBLY INSTRUCTIONS

SKU/ITEM#:716-T/732-T DINING TABLE

meridian.
furniture

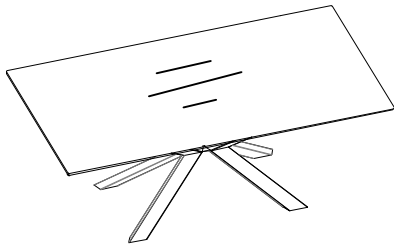

+ Do Not Use PowerTools



+ Suggested Adults

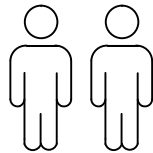

NOTE: For questions about parts or assembly please email support@meridianfurnitureusa.com or call us at 718-758-4455.

- 1 Read instructions cover to cover.
- 2 Save all packaging until assembly is completed.

1 IMPORTANT SAFETY INFORMATION

Do not assemble the product if any of the following parts arrived damaged:

- Part ① Glass table top
- Part ② Table base
- Part ③ Connector

Tempered Glass Warning: Should the tempered glass chip at ANY point throughout ownership please immediately discontinue use of the table to avoid injury.

CAUTION: DO NOT place hot object (100°F or more) directly on the glass surface

2 IMPORTANT ASSEMBLY INFORMATION

Assembly Step 1

Use C,D to connect ③ to ②

Assembly Step 2

Use B,D to connect ② to ①

+ Parts Included

① Glass table top 1PC

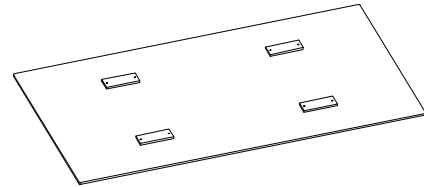

② Table base 2PCS

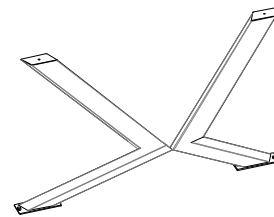

③ Connector 1PC

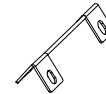

+ Hardware Included

A ALLEN WRENCH 1PC

M8



B BOLT 8PCS

M8*10MM



C BOLT 4PCS

M8*15MM



D FLAT WASHER 12PCS

Ø18*Ø8



ASSEMBLY INSTRUCTIONS

SKU/ITEM#:716-T/732-T DINING TABLE

meridian.
furniture

1

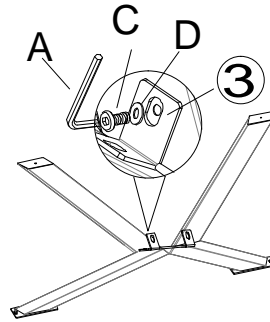

2

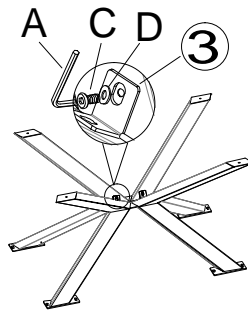

IMPORTANT: BE SURE NOT TO TIGHTEN ALL SCREWS HERE UNTIL YOU CAN ALIGN GLASS AND BASE IN STEP 3

3

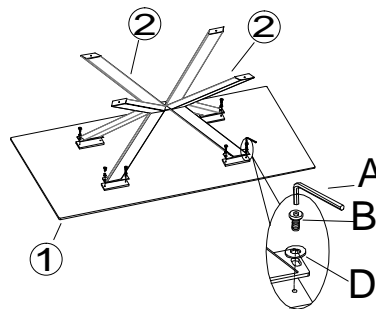

4

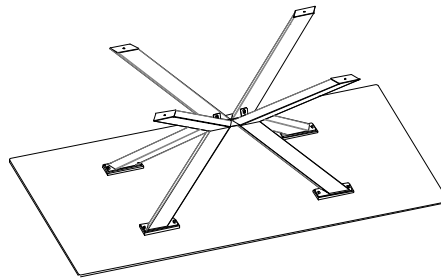

ATTENTION: WHEN YOU ASSEMBLE, PLEASE DON'T TIGHTEN EACH SCREW UNTIL ALL SCREWS ARE LINED UP WITH THE FRAME.

NOTE: For questions about parts or assembly please email support@meridianfurnitureusa.com or call us at 718-758-4455.

[www.Meridian Furniture USA.com](http://www.MeridianFurnitureUSA.com) | support@meridianfurnitureusa.com