

MOD - 6520

Thank you for purchasing the **MODWAY BED!**

Before you start, here are some helpful advice:

1. We suggest you spend a short time reading through this leaflet and then follow the simple step instructions.
2. Owing to the size and weight of the bed, we recommend that it is assembled by two adults, on a carpeted or padded area, in the room that it is intended for. Approximate assembly time: 20 minutes.
3. Please do not use any tools other than those provided or recommended in these instructions.
4. Please do not throw away any of the packaging or the instruction until you have checked all the components and hardware and the furniture is fully assembled. Please ensure that the packaging is disposed of in a safe environmentally friendly way.
5. Assemble all components loosely until advised to tighten. Depending on use, it may be necessary to tighten the components from time to time, so please save tools that have been provided.
6. Please keep all fitting out of reach of children.

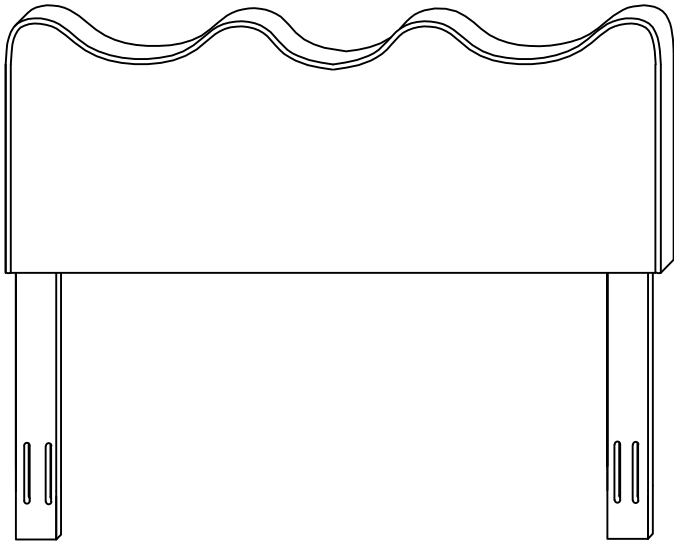

Component:

A	HEADBOARD	1 PC
B	SUPPORT WOOD	2 PCS
C	BED FRAME (DOES NOT INCLUDE WITH THE PURCHASE)	-









MOD - 6520

HARDWARE HEADBOARD

- 1  JCBB BOLT M8 x 60mm 4 PCS
- 2  M8 FLAT WASHER 4 PCS
- 3  M5 ALLEN KEY 1 PC

HARDWARE BED FRAME

- 4  JCBB BOLT M6 x 60mm 4 PCS
- 5  JCBB BOLT M6 x 35mm 4 PCS
- 6  M6 FLAT WASHER 8 PCS
- 7  M6 SPRING WASHER 4 PCS
- 8  M6 HEX NUT 4 PCS
- 9  M4 ALLEN KEY 1 PC

STEP 1

- 1.1 Open the zip at the **Headboard (A)** backing and take out all the parts.
- 1.2 Align pre-drilled **Support Wood (B)** holes over the pre-drilled headboard holes according to your desired **Headboard (A)** height.
- 1.3 Secure each **Support Wood (B)** by using 2x **JCBB Bolt (1)** and 2x **M8 Flat Washer (2)**. Tighten with supplied **Allen Key (3)**. Repeat the same procedure to secure the other side.

Note: Hardware may loosen over time.
Periodically check that all connections are tight.

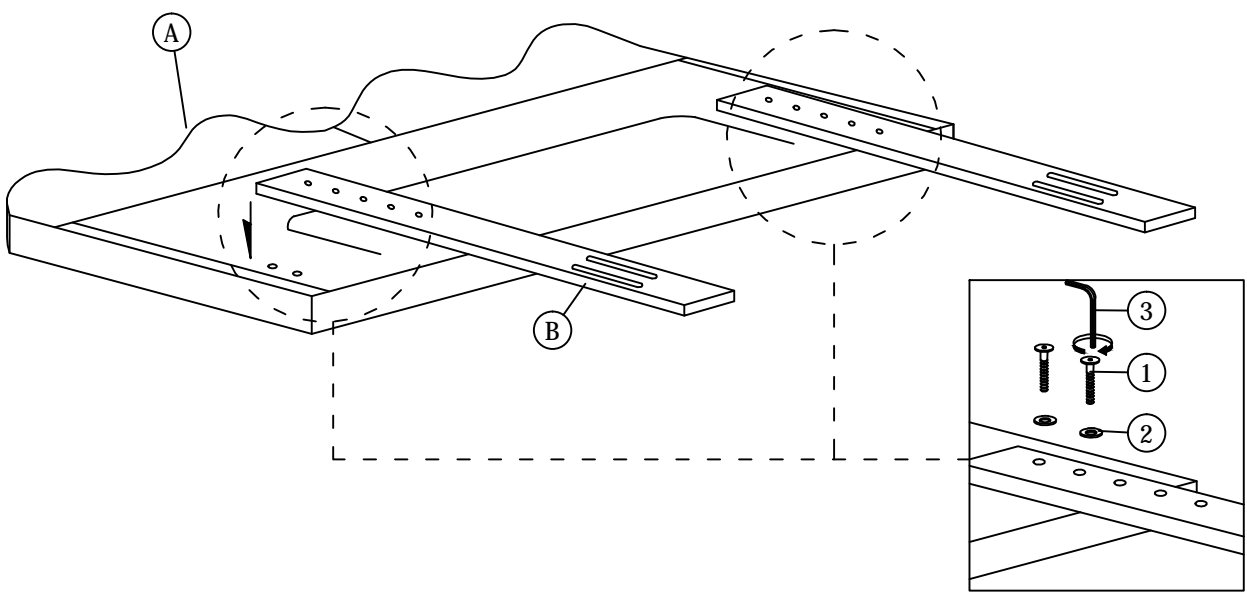

MOD - 6520

STEP 2

2.1 Line up the **Bed Frame (C)** board's pre-drilled holes to match those of the **Headboard (A)**.

2.2 Secure the **Headboard (A)** to the **Bed Frame (C)** by using 2x **bolt (4)** for the thicker bed frame, and 2x **Bolt (5)** for the thinner bed frame. Before inserting each bolt, place a **Spring Washer (7)** and **Flat Washer (6)** on each bolt. Then fit a **Flat Washer (6)** on the screw as it protrudes through the other side of the bed frame.

2.3 Place a **Hex Nut (8)** after the **Flat Washer (6)** at the end of each screw. Then tighten by using the **Allen Key (9)**.

2.4 Repeat the same procedure for each screw and each side of the bed frame.

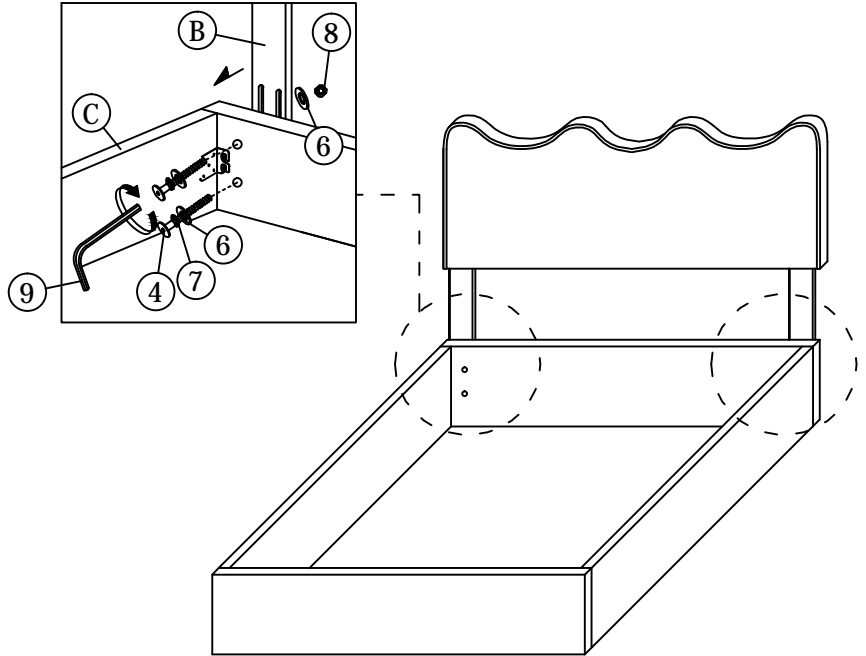

STEP 3

