

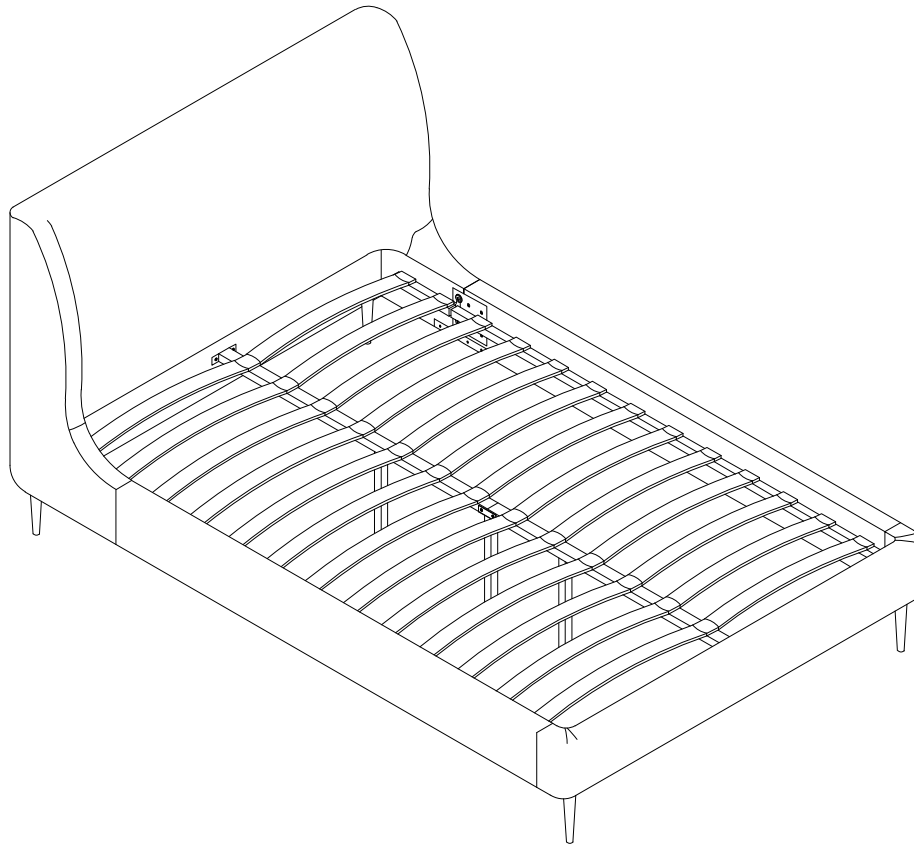





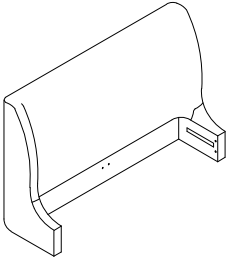
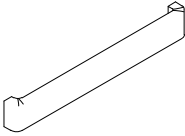
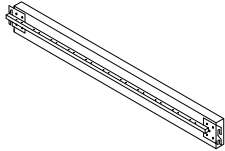
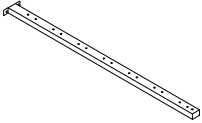
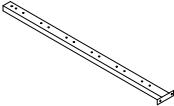
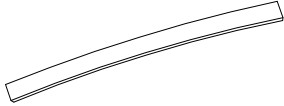

BD003

60" x 80"

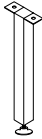
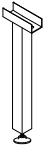
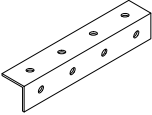
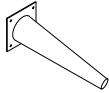
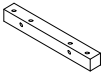
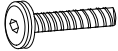
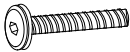

IMPORTANT NOTE

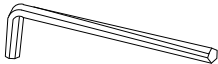
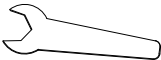
1. PLEASE CHECK THAT ALL PARTS ARE PRESENT BEFORE YOU START THE ASSEMBLY OF YOUR FURNITURE.
2. FOR THE PROTECTION OF YOUR FURNITURE, PLACE ALL PARTS ON A CLEAN AND SMOOTH SURFACE TO PREVENT ANY DAMAGE.
3. DO NOT USE POWER TOOLS TO ASSEMBLE THE BED.
4. PLEASE PERIODICALLY CHECK ALL FITTINGS AND RE-TIGHTEN AS NECESSARY.
5. DO NOT USE THE BED UNLESS ALL BOLTS AND SCREWS ARE FIRMLY SECURED.

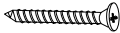
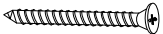
PART LIST		
(1)Headboard x 1pc 	(2)Footboard x 1pc 	(3)Crossrail x 2pcs 
(4)Centre Support Bar I x 1pc 	(5)Centre Support Bar II x 1pc 	(6)Slat x 26pcs 
(7)Double Plastic Cap x 13pcs 	(8)Single Plastic Cap x 26pcs 	(9)Support Leg I x 2pcs 
(10)Support Leg II x 1pc 	(11)Connection Metal Bar x 2pcs 	(12)Leg x 4pcs 
(13)Metal Support Rail x 2pcs 		
HARDWARE LIST		
(A)Bolt M8 x 25mm x 12pcs 	(B)Bolt M8 x 40mm x 6pcs 	(C)Nut M8 x 13mm x 6pcs 
(D)Spring Washer x 8pcs 	(E)Flat Washer x 18pcs 	(F)Allen Key M5 x 1pc 
(G)Spanner x 1pc 	(H)Screw M4 x 20mm x 16pcs 	(I)Screw M4 x 35mm x 16pcs 
(J)Black Screw M5 x 45mm x 4pcs 		

STEP 1

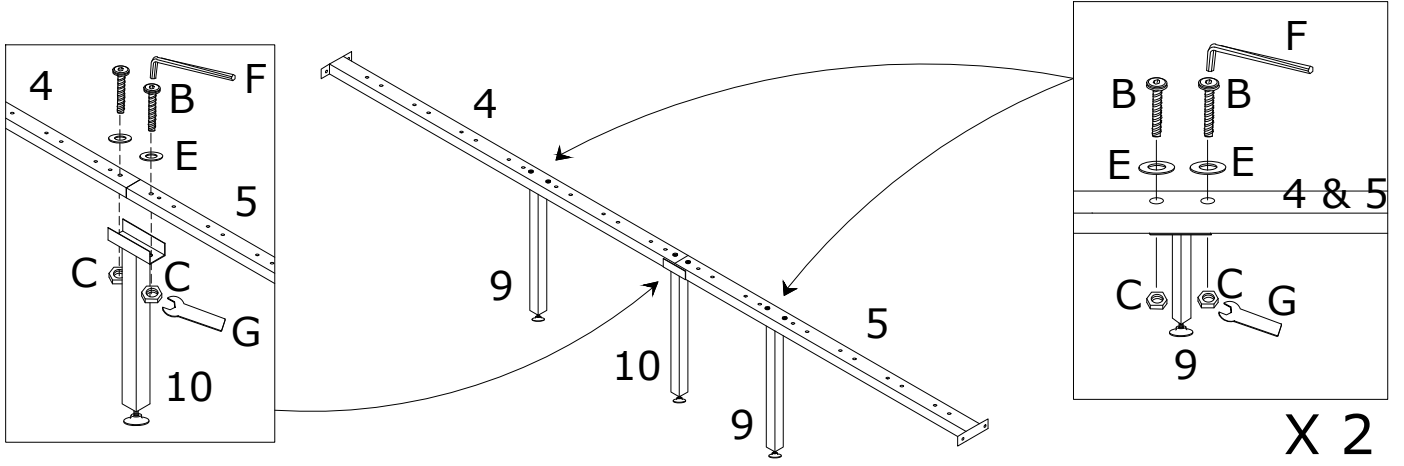

STEP 2

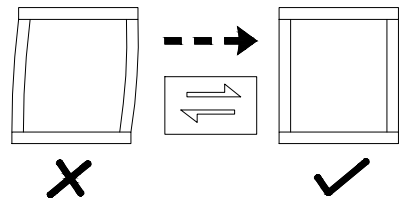
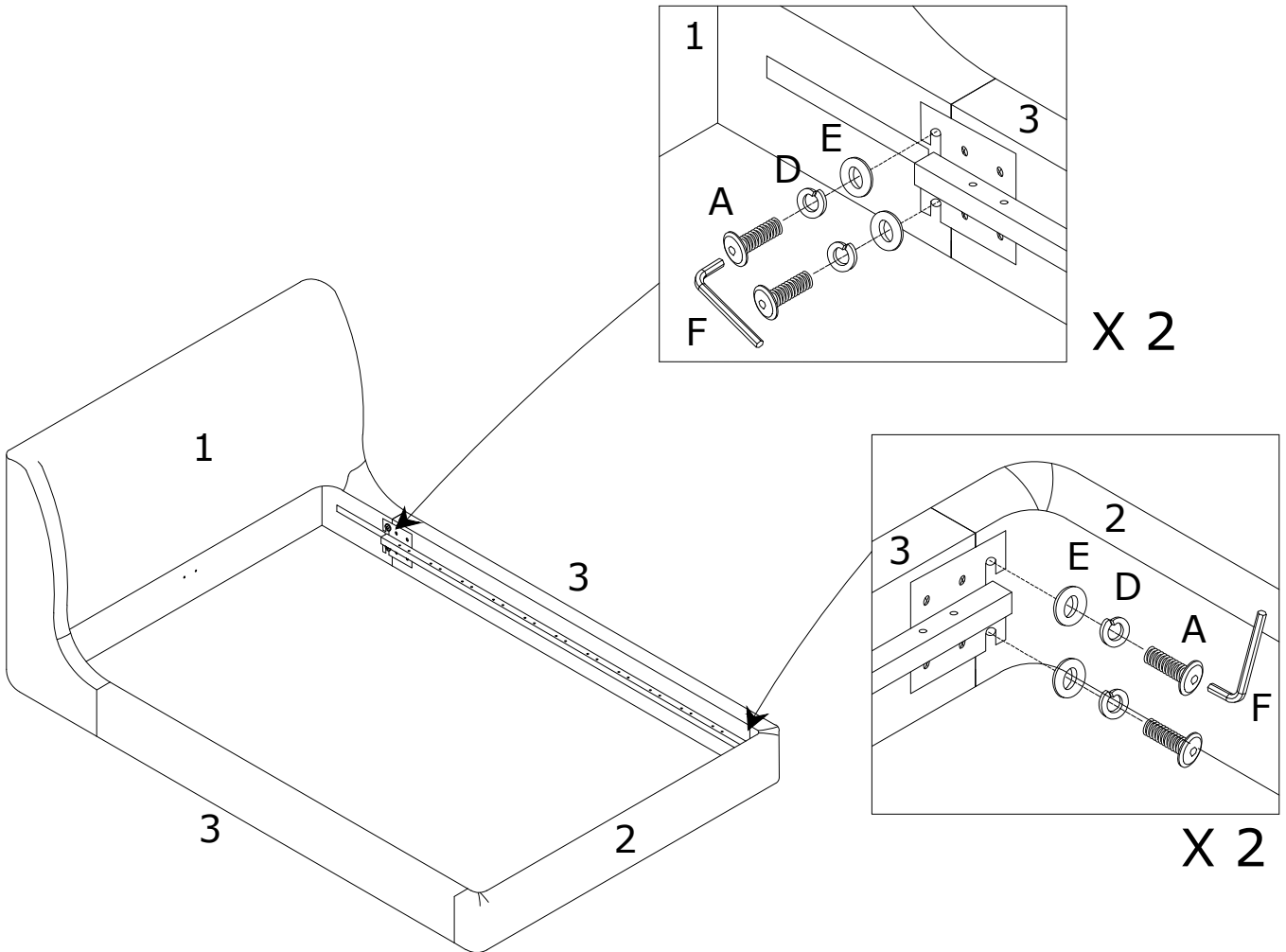

STEP 3

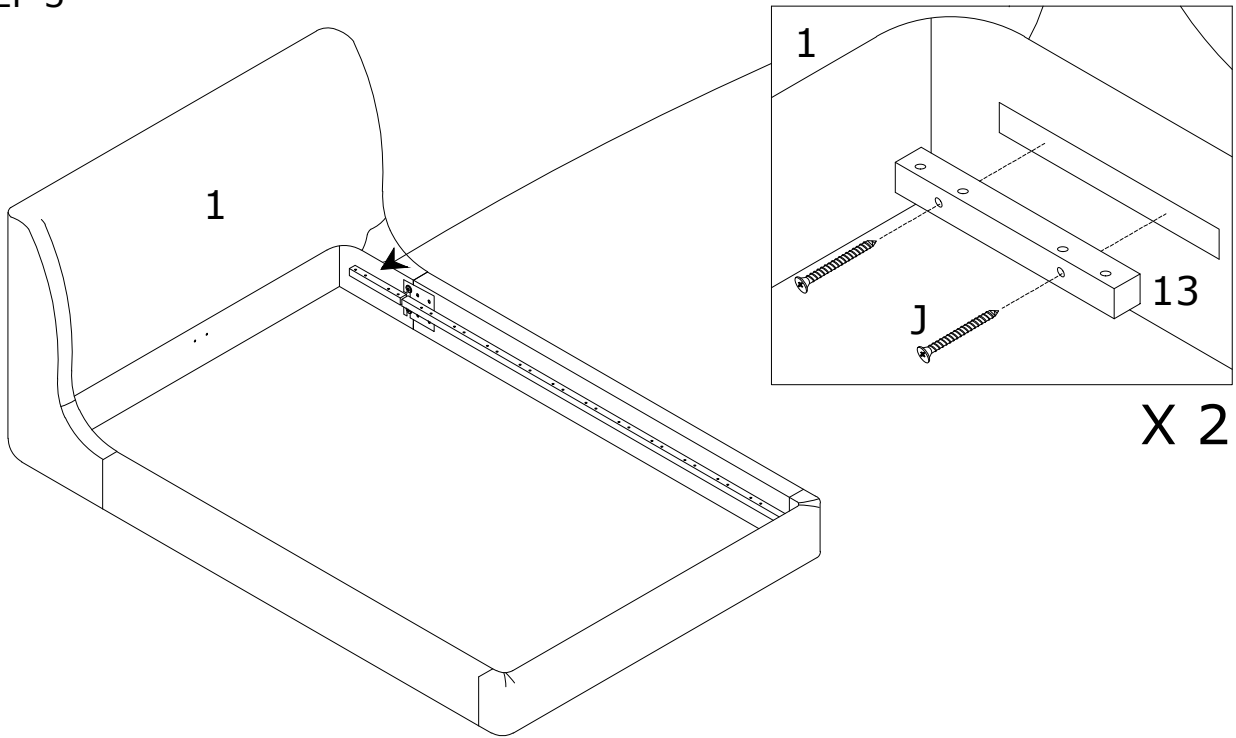

STEP 4

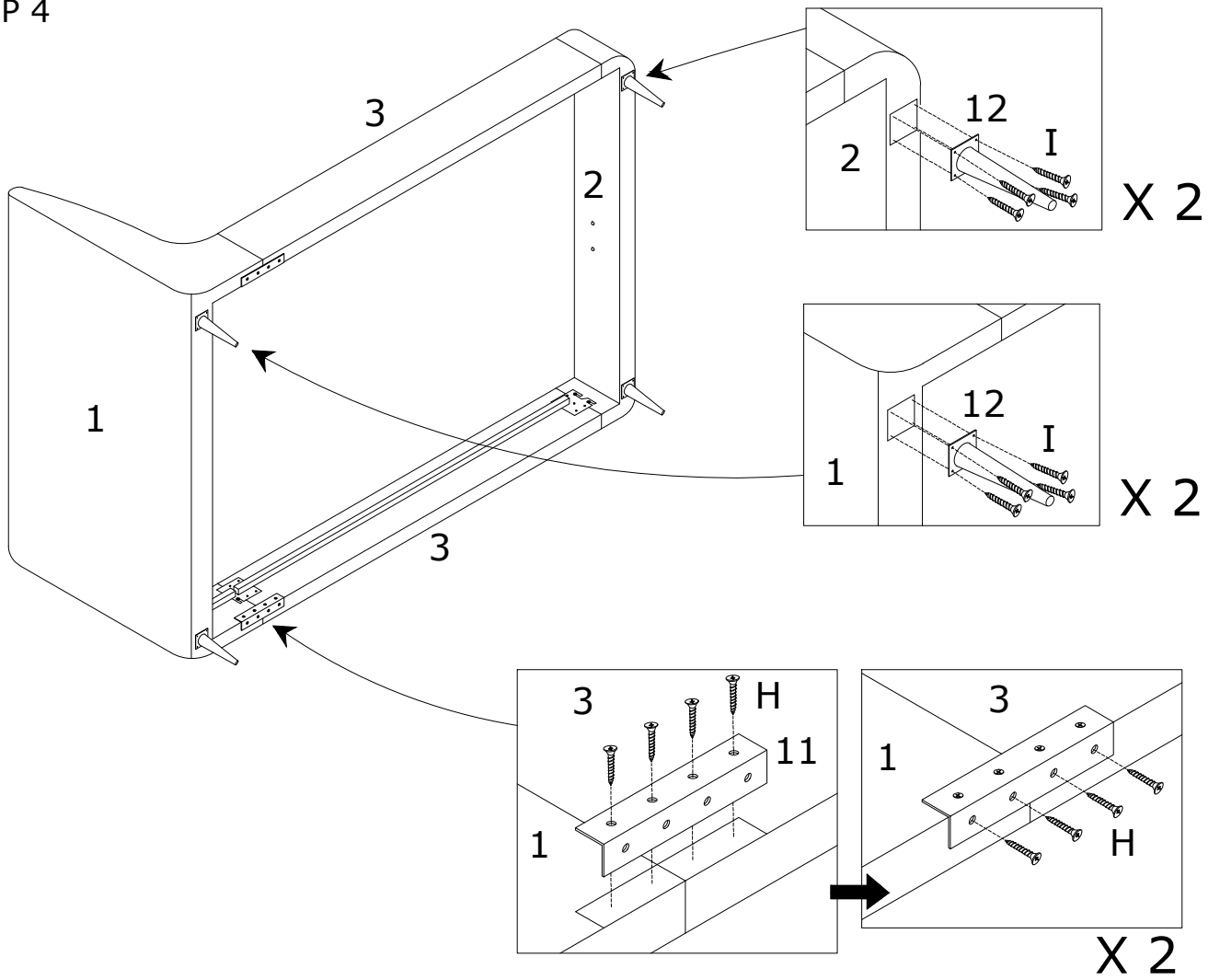

STEP 5

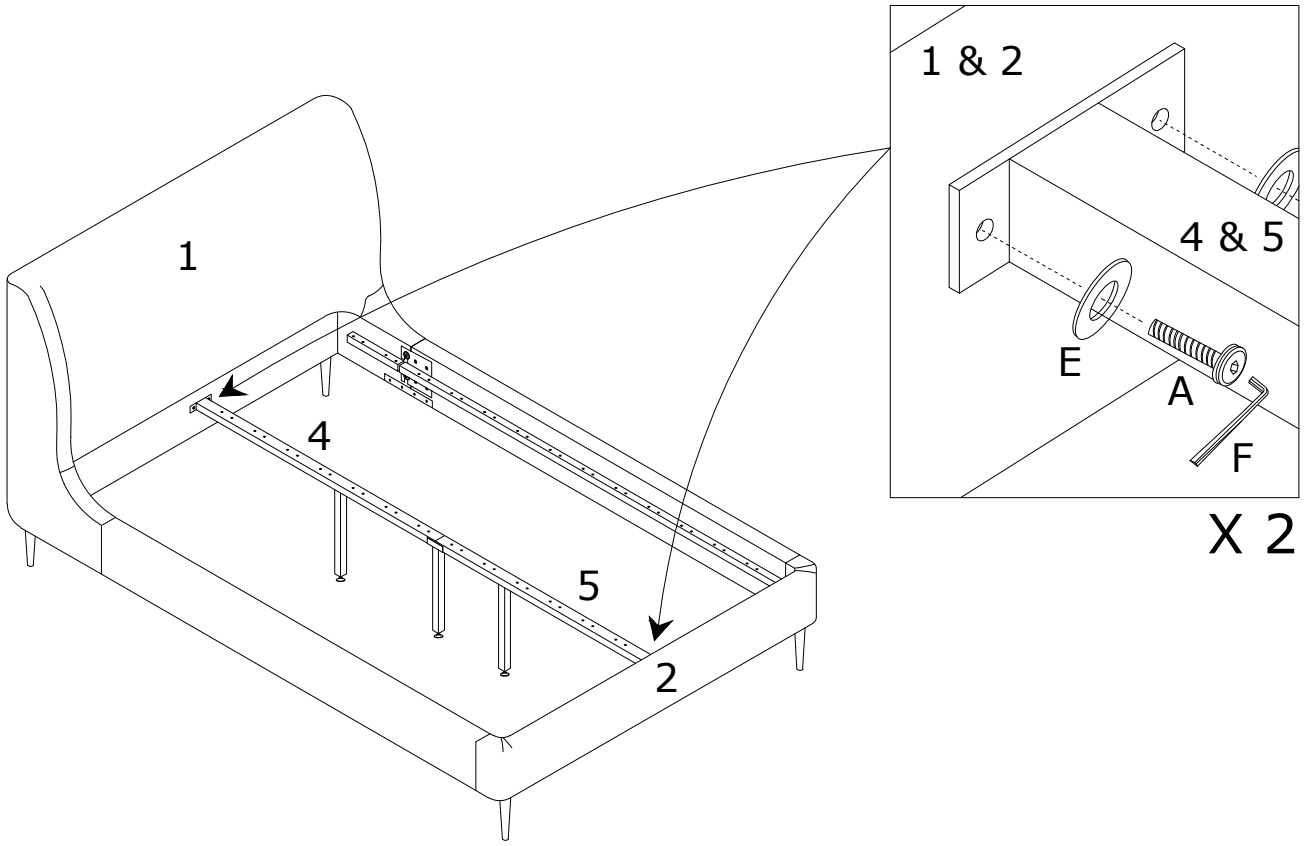

STEP 6

