



ASSEMBLY INSTRUCTIONS
NOTICE DE MONTAGE
INSTRUCCIONES DE MONTAJE

COD BR: BE 71
COD US: 308AMC182, 308AMC157

Summary

Résumé

Resumen

Introduction	3
Introduction		
Introducción		
QR Code guide	3
Guide de QR Code		
Guía de códigos QR		
Before starting	4
Avant de commencer		
Antes de comenzar		
Avoid accidents	4
Éviter les accidents		
Evitar accidentes		
Dimensions and tools	5
Dimensions et outils		
Dimensiones y herramientas		
Identifying parts	6
Identification des pièces		
Identificación de las piezas		
Hardware included in box	7
Accessoires inclus dans la boîte		
Accesorios incluidos en la caja		
Furniture assembly	8
Montage de meuble		
Montaje del mueble		

Introduction

Introduction

Introducción

Important

Important

Importante

Read this manual and follow the steps in order to keep the guarantee and also for the perfect fit.

Lisez ce manuel et suivez les étapes afin de conserver la garantie et aussi pour un ajustement parfait.

Lea este manual y siga los pasos para que el producto no pierda la garantía y también para el ajuste perfecto.

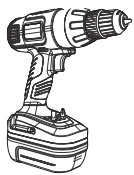

Some parts may have just pre-drilled holes, then use an electric screwdriver to improve assembly.

Certaines pièces peuvent seulement avoir un pré-perçage, utilisez un tournevis électrique pour améliorer l'assemblage.

Algunas partes pueden tener solo pre-huecos, utilice un destornillador para mejorar el armado.

Scan QR codes to help with assembly steps.

You can access the whole playlist scanning this QR code

Scannez les codes QR pour vous aider avec les étapes d'assemblage.

Vous pouvez accéder à toute la playlist en scannant ce code QR.

Utilice los códigos QR para ayudar en los pasos de armado.

Usted puede chequear la lista completa de vídeos utilizando este código QR



Unboxing

Déballage

Desempaquetado



Attach hinges to sides

Fixation de la charnière sur le côté

Fijar bisagra a lateral



Cleaning pieces

Nettoyage de pièces

Limpieza de las piezas



Attach hinges to doors

Fixation de la charnière sur la porte

Fijar bisagra a puerta



Organizing hardware

Organizer le matériel

Organizando los herrajes



Doors adjustment

Réglage de la porte

Ajuste de la puerta



Fixing minifix screw

Minifix vis

Fijación de minifix



Fixing to the wall

Fixation au mur

Fijación a la pared

Before starting
Avant de commencer
Antes de comenzar

Prepare the room before starting the assembly, leaving it completely clean and the area in good condition to start the work.

Avant de commencer l'assemblage, préparez l'environnement en le laissant complètement propre et avec un bon espace pour commencer le travail.

Antes de comenzar el montaje preparar el ambiente, dejándolo completamente limpio y con bueno espacio para comenzar el trabajo.

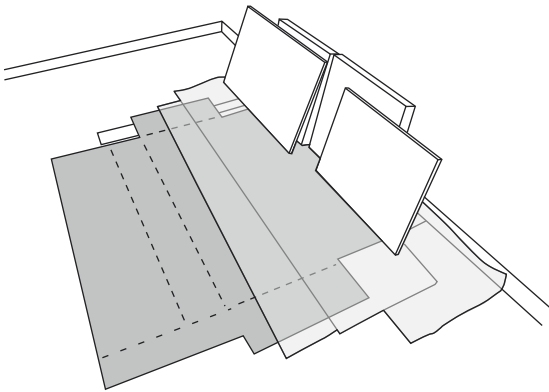

Use the cardboard of the packaging to separate and support the parts removed from the boxes.

Utilisez le carton de l'emballage pour séparer et soutenir les pièces retirées des boîtes

Utilice el cartón de la embalaje para separar y apoyar las piezas desmontadas de las cajas.

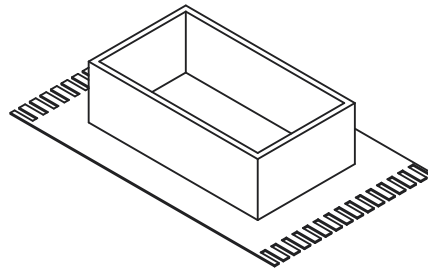

Cover the assembly area with a blanket or carpet to avoid damaging the parts during the assembly process.

Couvrir la zone d'assemblage avec une couverture ou un tapis pour éviter d'endommager les pièces pendant le processus d'assemblage.

Cubrir la zona de ensamble con una manta o alfombra. De este modo, se evitan daños en las piezas durante el proceso de montaje.

SCAN TO WATCH THE VIDEO
Scannez pour regarder la vidéo
Scanea para ver el vídeo



Avoid accidents
Éviter les accidents
Evitar accidentes

We request you to carefully observe the assembly instructions as: fixing the product on the wall, adding glue in needed and specific places, product weight limit, etc.

Nous vous demandons de lire attentivement les instructions, principalement les informations sur la fixation du produit sur le mur, le placement de la colle dans un endroit spécifique et nécessaire, le poids supporté par le produit etc...

Pedimos que lea atentamente las instrucciones, principalmente las informaciones de fijación del producto en la pared, colocación de pegamento en local específico y necesario, el peso soportado por el producto etc...

Do not climb or lean on the furniture.

Ne grimpez pas et ne vous appuyez pas sur les meubles.

No se suba ni se apoye en el mueble.

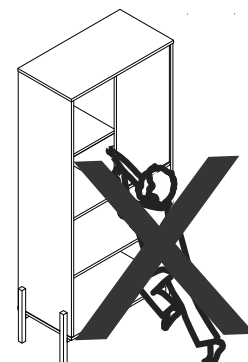

Dimensions and tools
Dimensions et outils
Dimensiones y herramientas

Dimensions:

W: 28,54 H: 60,43 D: 13,97 inches

Dimensions / Dimensiones:

L: 725 A: 1535 P: 355 mm

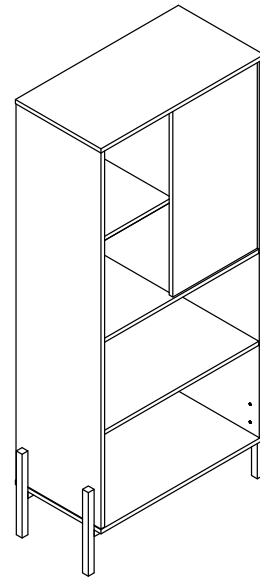

Cleaning
Vettoyage
Limpieza

You can clean the product with slightly dampened cloth followed by a dry cloth.

Do not use chemicals or abrasives.

Chiffon légèrement humecté d'eau, puis chiffon sec, ne pas utiliser de produits chimiques ou abrasifs.
Solamente utilizar un paño húmedo y después un paño seco, no utilice productos químicos o abrasivos.

All the furniture parts have been marked with a number. Before you start assembling, please identify the numbered parts in relation to the assembly instructions. Once assembly is completed, the numbers can be easily removed with a cloth slightly damped in alcohol. Use alcohol only to remove part numbers.

Toutes les pièces mobiles ont été marquées par un nombre. Avant de commencer l'assemblage, identifiez les pièces numéroté par rapport aux instructions de montage. Une fois l'assemblage terminé, les chiffres peuvent être facilement enlevé avec un chiffon légèrement trempé dans l'alcool. Utilisez de l'alcool uniquement pour supprimer les références.

Todos las piezas del mueble fueron marcadas con un número. Antes de empezar el montaje, identifique las piezas numeradas en relación con las instrucciones de montaje. Una vez que se completa el armado, los números se pueden quitar fácilmente con un paño ligeramente empapado en alcohol. Use alcohol solo para eliminar números de las piezas.

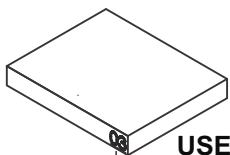

USE ALCOHOL ONLY TO REMOVE PART NUMBERS

UTILISEZ DE L'ALCOOL UNIQUEMENT POUR SUPPRIMER LE NOMBRE DE PIÈCES

UTILICE ALCOHOL SOLAMENTE PARA ELIMINAR EL NUMERO DE LAS PIEZAS

SCAN TO WATCH THE VIDEO

*Scannez pour regarder la vidéo
Scanea para ver el vídeo*

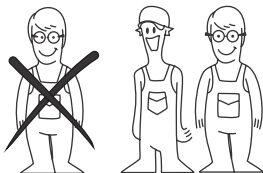

To improve assembly, use an electronic screwdriver.

Pour faciliter l'assemblage, utilisez un tournevis électrique.

Para facilitar el armado, utilice un destornillador eléctrico.

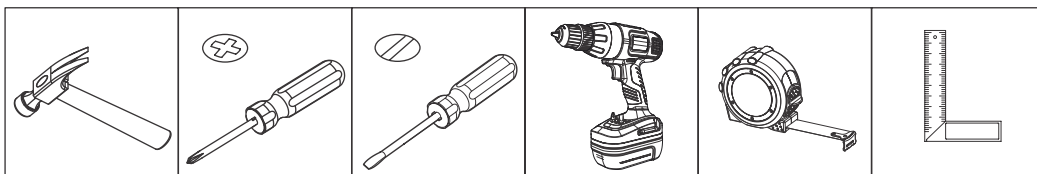

COD BR: BE 71
 COD US: 308AMC182, 308AMC157

PART	DESCRIPTION	QTY	PIÈCE	DESCRIPTION	QUANT.	PIEZA	DESCRIPCIÓN	CANTIDAD
001	Base	1	001	Base	1	001	Base	1
002	Top	1	002	Plateau	1	002	Tapa	1
003	Left side	1	003	Côté gauche	1	003	Lateral izquierda	1
004	Right side	1	004	Côté droit	1	004	Lateral derecha	1
005	Lower shelf	1	005	Étagère inférieure	1	005	Repisa inferior	1
006	Central shelf	1	006	Étagère central	1	006	Repisa central	1
007	Upper shelf	1	007	Étagère supérieure	1	007	Repisa superior	1
008	Partition	1	008	Partition	1	008	Partición	1
009	Door	1	009	Porte	1	009	Puerta	1
010	Upper back	1	010	Dos supérieure	1	010	Revés superior	1
011	Lower back	1	011	Dos inférieure	1	011	Revés inferior	1
012	Feet	2	012	Pieds	2	012	Pies	2

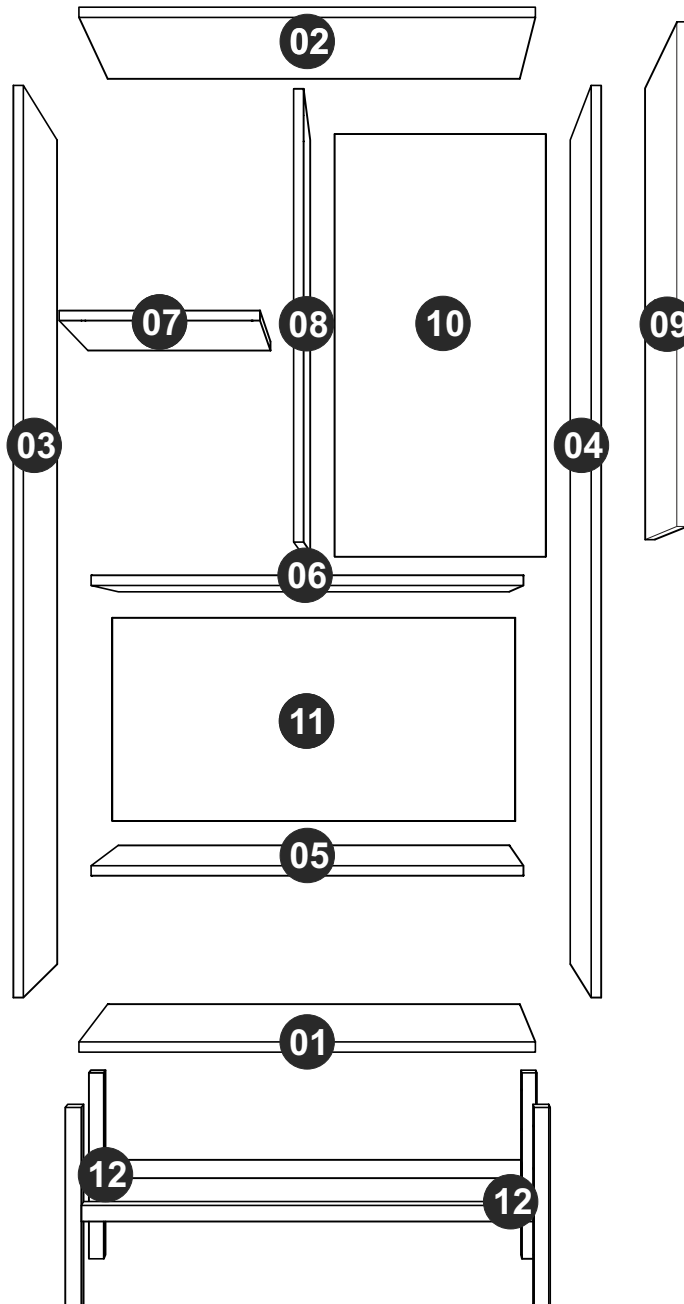

Hardware included in box

Accessoires inclus dans la boîte

Accesorios incluidos en la caja

SCAN TO WATCH THE VIDEO

*Scannez pour regarder la vidéo
Scanea para ver el vídeo*



EF 000033x 24



EF 000094 X 18



EF 000106 X 08



EF 000136 x 08



EF 000132 x 06

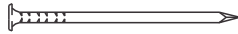

EF 000168 X 36



EF 000216 X 18

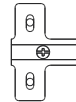

EF 000025 X 02



EF 000246 X 1



EF 000016 X 1

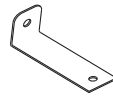

EF 000529 X 1



EF 000248 x 1

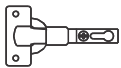

EF 000043 X 02



CHALK x 01
CRAIE x 01
TIZA x 01

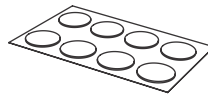

STICKER x 28
ADHÉSIF x 28
TAPAS PLÁSTICAS x 28

A = 8 KG - 17,63 LB

B = 4 KG - 8,81 LB

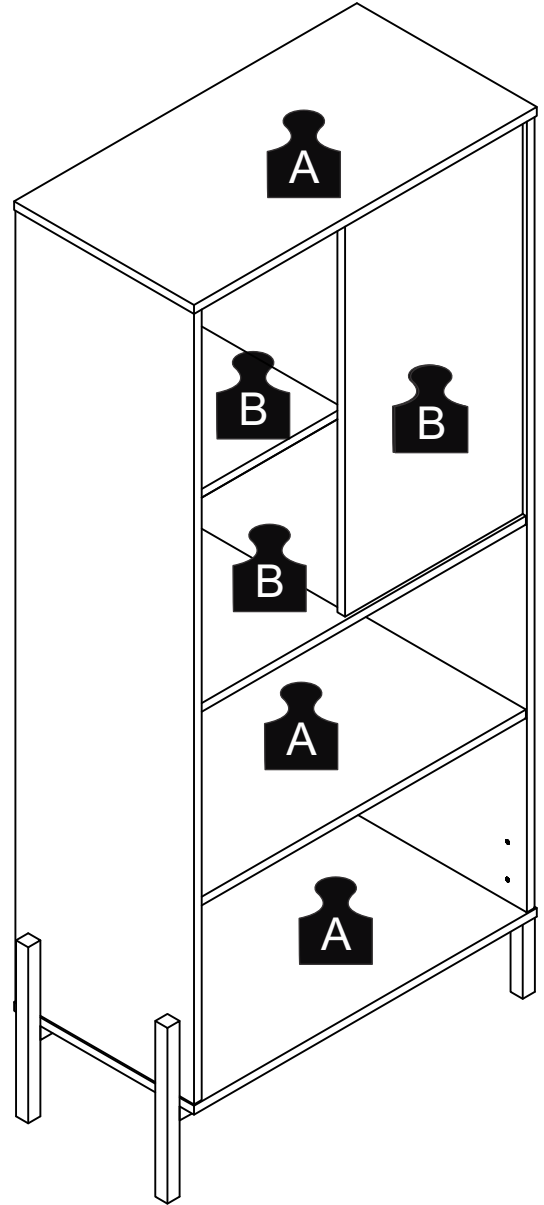

STEP 1 / ÉTAPE 1 / PASO 1
Attach hardware EF 000043 to piece 09 using hardware EF 000106.
Fixez le matériel EF 000043 à la pièce 09 à l'aide du matériel EF 000106.
Fije el herraje EF 000043 en la pieza 09 utilizando el herraje EF 000106.

SCAN TO WATCH THE VIDEO
Scannez pour regarder la vidéo
Scanea para ver el vídeo

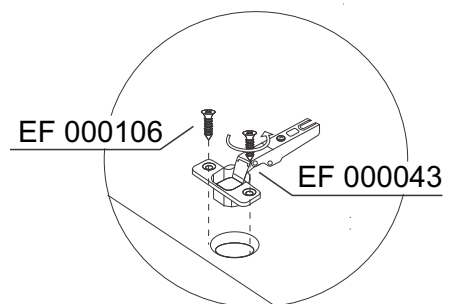
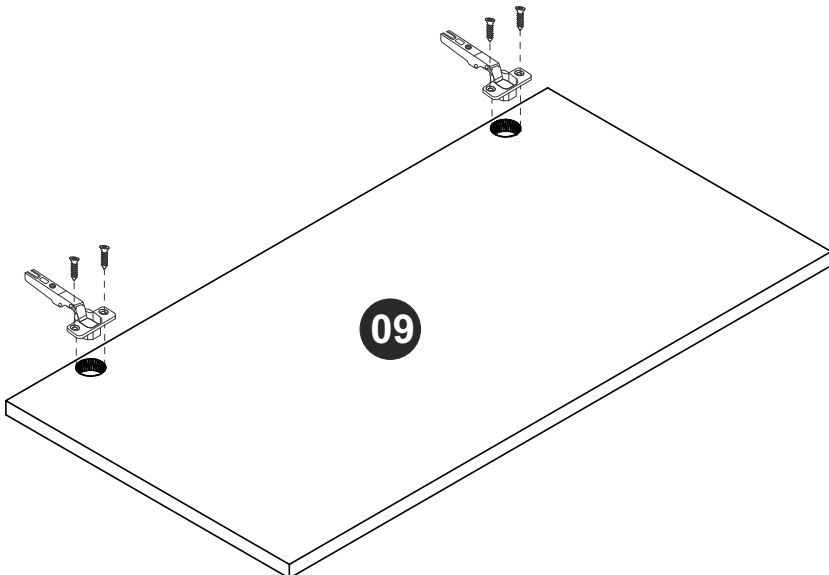

STEP 2 / ÉTAPE 2 / PASO 2

Insert hardware EF 000033 into pieces 03, 05, 06, 07 and 08.

Insérez le matériel EF 000033 dans les pièces 03, 05, 06, 07 et 08.

Añade el herraje EF 000033 en las piezas 03, 05, 06, 07 y 08.

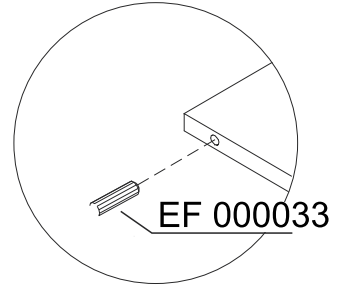
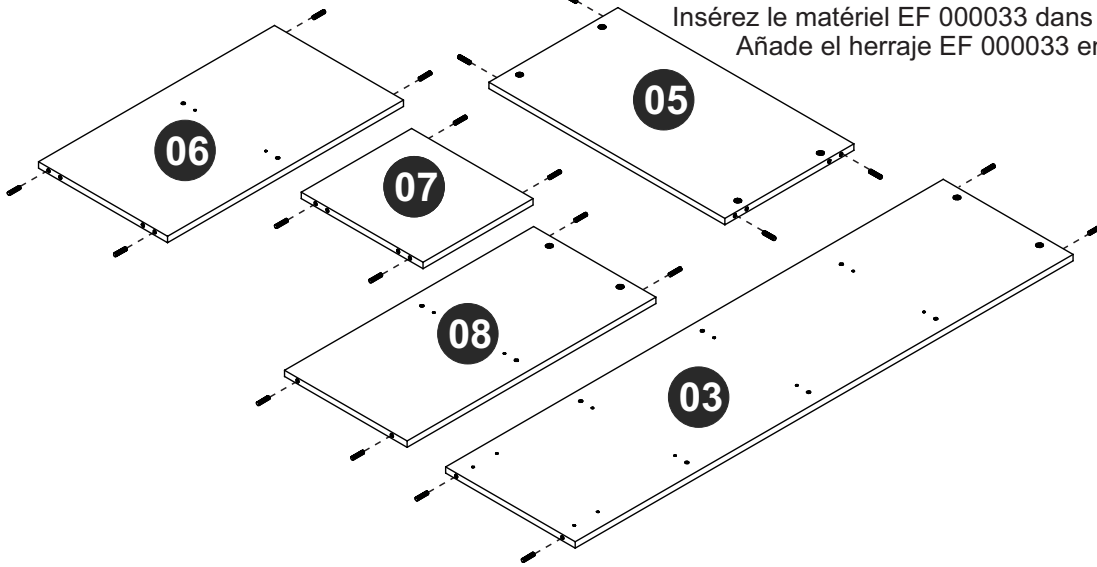

STEP 3 / ÉTAPE 3 / PASO 3

Insert hardware EF 000094 into pieces 02, 03, 04 and 08.

Insérez le matériel EF 000094 dans les pièces 02, 03, 04 et 08.

Fije el herraje EF 000094 en las piezas 02, 03, 04 y 08.

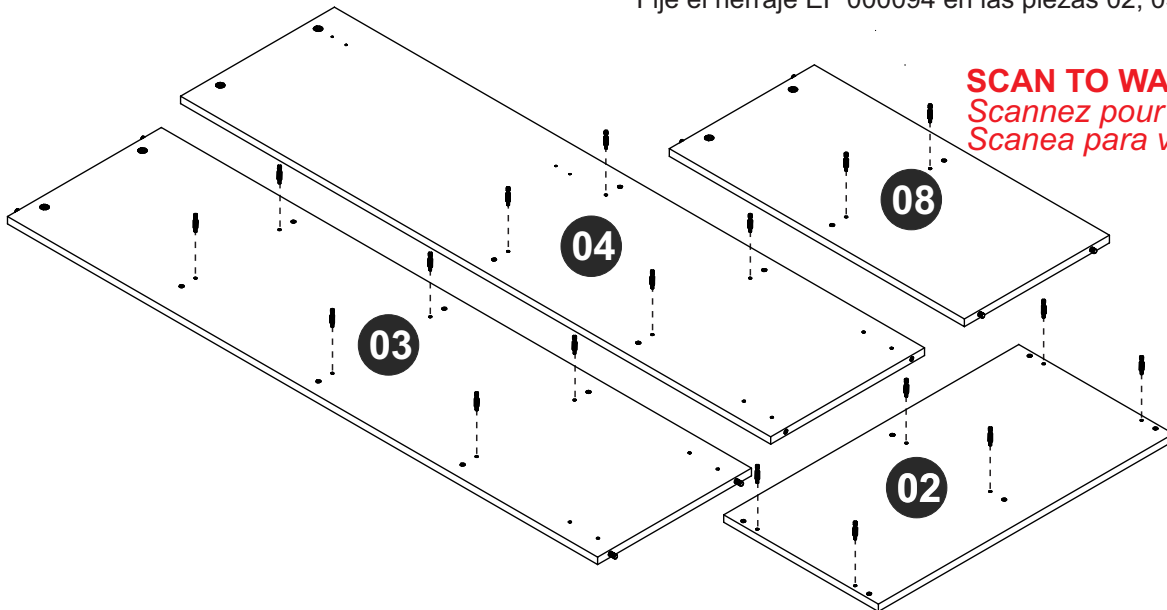

SCAN TO WATCH THE VIDEO
Scannez pour regarder la vidéo
Scanea para ver el vídeo

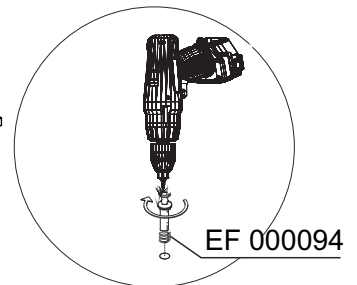

STEP 4 / ÉTAPE 4 / PASO 4

Insert hardware EF 000033 at pre-drilled holes in piece 04. Fix hardware EF 000025 using hardware EF 000106.

Insérez le matériel EF 000033 dans les pré-trous de la pièce 04. Fixez le matériel EF 000025 à l'aide du matériel EF 000106.

Añade el herraje EF 000033 en la pieza 04. Fije el herraje EF 000025 utilizando el herraje EF 000106.

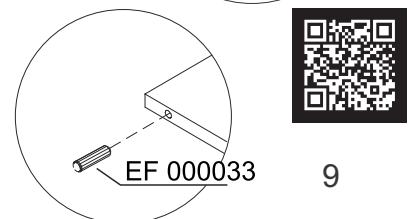
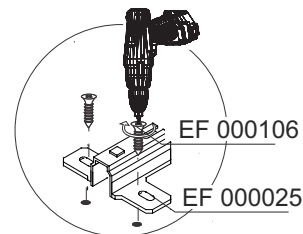
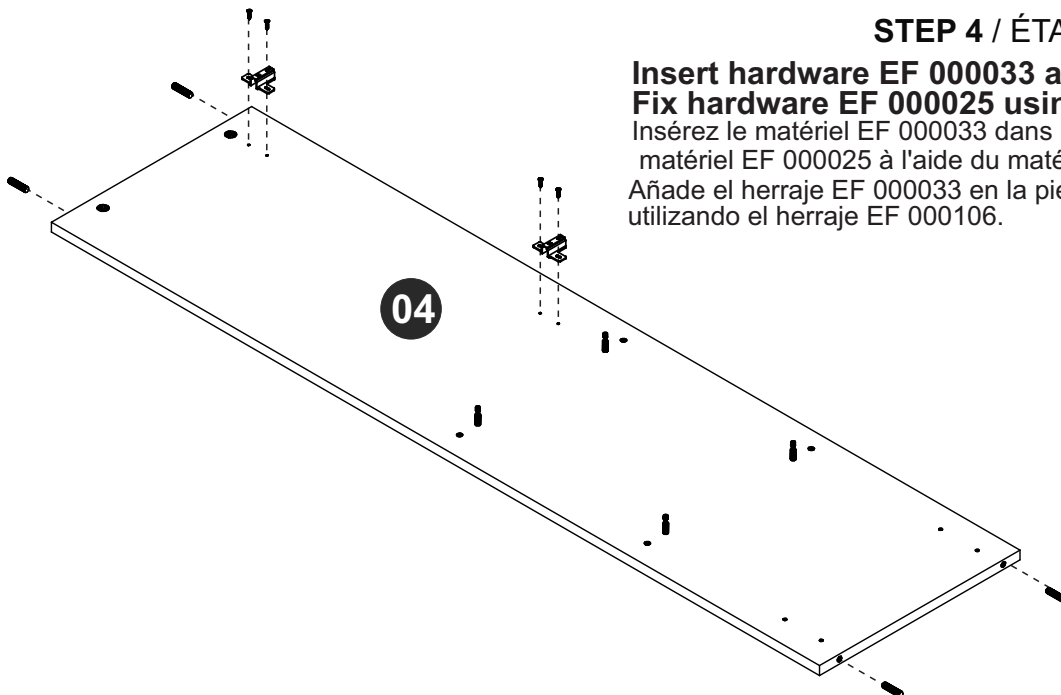

STEP 5 / ÉTAPE 5 / PASO 5

Connect pieces 06 and 08 using hardware EF 000132, connect piece 07 insert hardware EF 000216 and turn to tighten.

Connectez les pièces 06 et 08 à l'aide du matériel EF 000132. Connectez la pièce 07, insérez le matériel EF 000216 et tournez pour serrer.

Junte las piezas 06 y 08 utilizando el herraje EF 000132, junte la pieza 07, añade el herraje EF 000216 y gire para apretar.

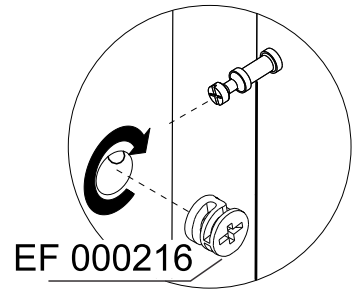
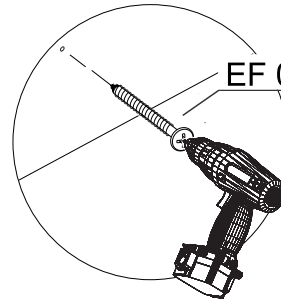
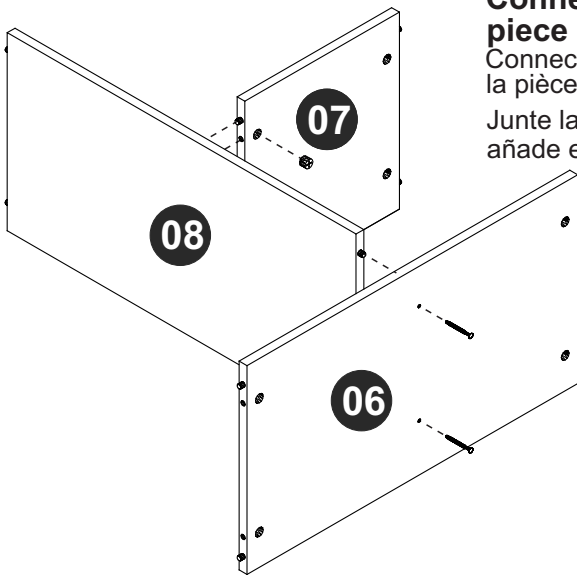

STEP 6 / ÉTAPE 6 / PASO 6

Connectez les pièces 03, 04 et 05 à la pièce assemblée à l'étape précédente. Insérez le matériel EF 000216 et tournez pour serrer.

Connect pieces 03, 04 and 05 to the part assembled in the previous step. Insert hardware EF 000216 and turn to tighten.

Junte las piezas 03, 04 y 05 a la parte armada en el paso anterior. Añade el herraje EF 000216 y gire para apretar.

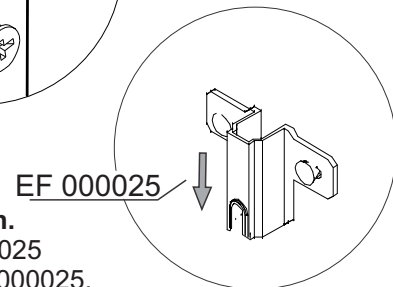
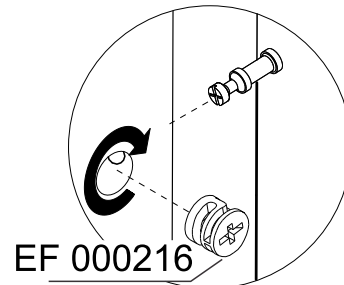
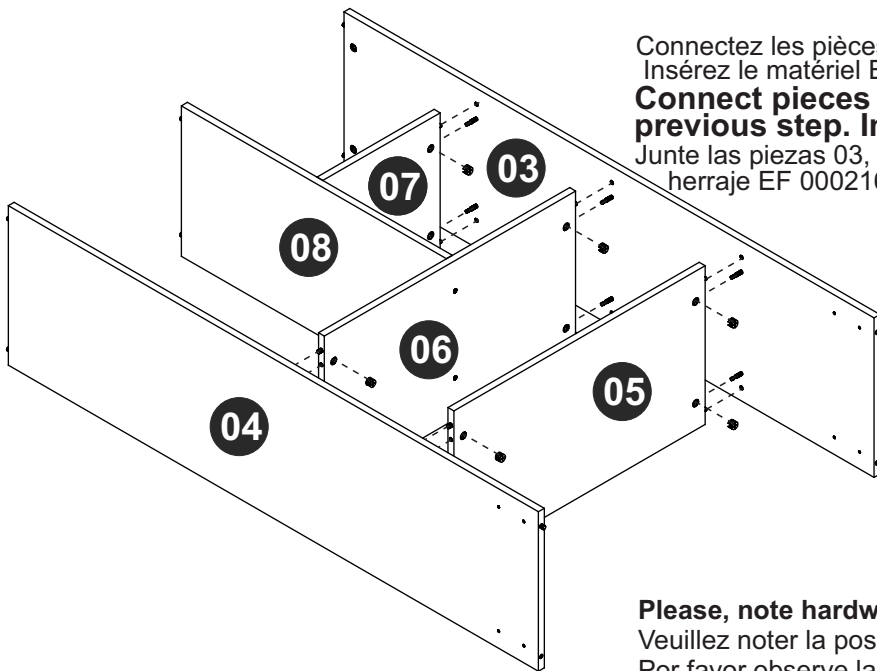

Please, note hardware EF 000025 position.

Veuillez noter la position du matériel EF 000025

Por favor observe la posición del herraje EF000025.

STEP 7 / ÉTAPE 7 / PASO 7

Connect piece 02 insert hardware EF 000216 and turn to tighten.

Connectez la pièce 02, insérez le matériel EF 000216 et tournez pour serrer.

Junte la pieza 02 añade el herraje EF 000216 y gire para apretar.

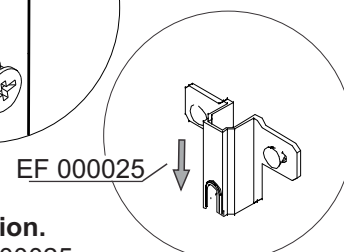
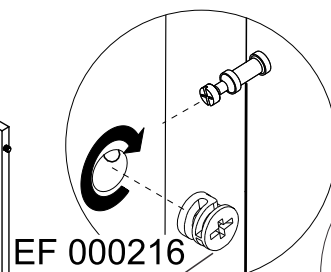
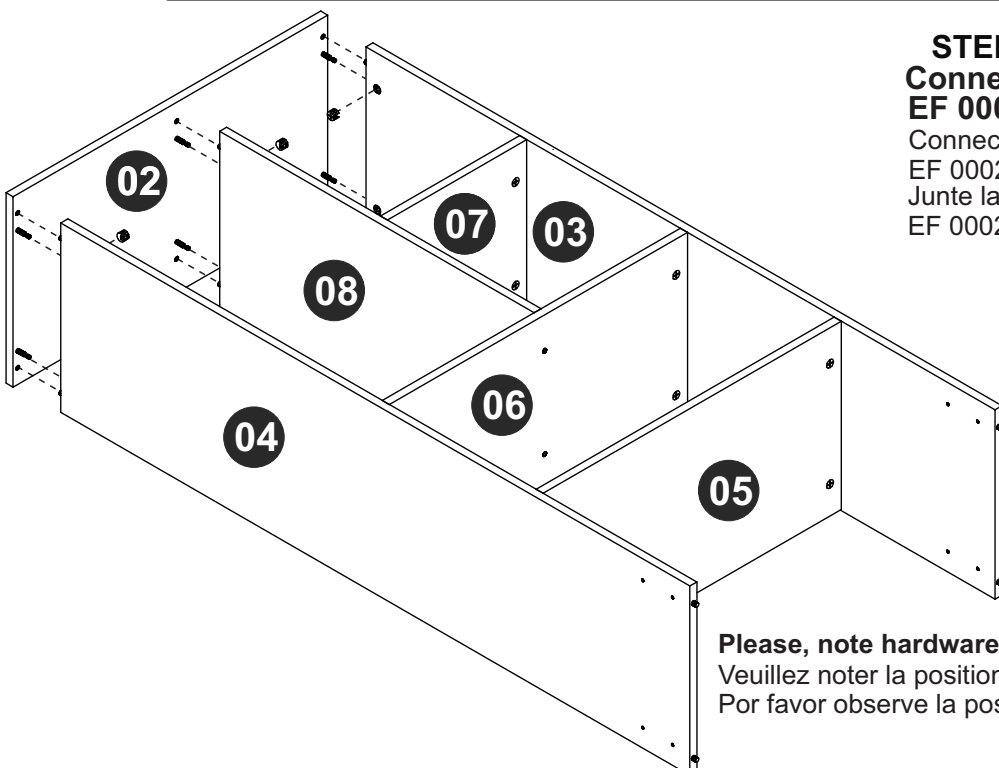

Please, note hardware EF 000025 position.

Veuillez noter la position du matériel EF 000025

Por favor observe la posición del herraje EF000025.

STEP 8 / ÉTAPE 8 / PASO 8

Connect pieces 01, 03 and 04 using hardware EF 000132.
Connectez les pièces 01, 03 et 04 à l'aide du matériel EF 000132.
Junte las piezas 01, 03 y 04 utilizando el herraje EF 000132.

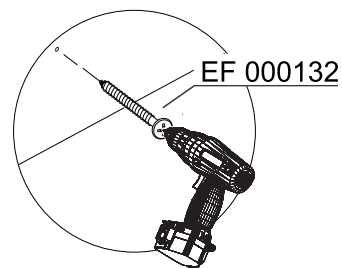
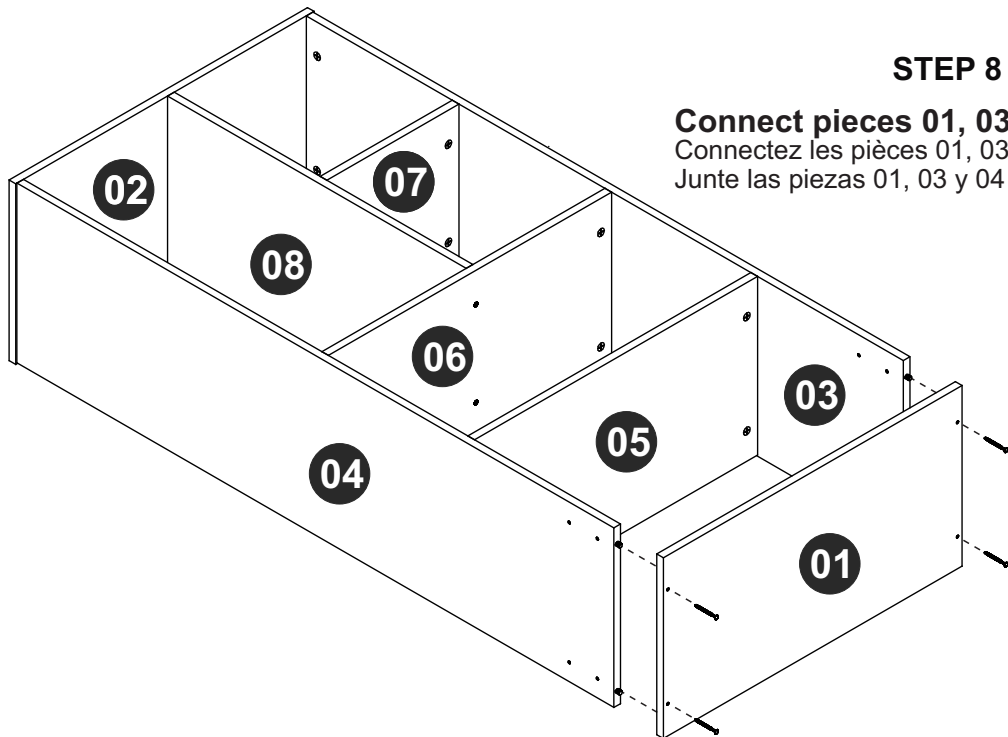

STEP 9 / ÉTAPE 9 / PASO 9

Fix the feet (pieces 12) to the part assembled in the previous step using hardware EF 000136.

Fixez les pieds (pièces 12) à la pièce montée à l'étape à l'aide du matériel EF 000136.
Fije los pies (piezas 12) a la parte armada en el paso anterior utilizando el herraje EF 000136.

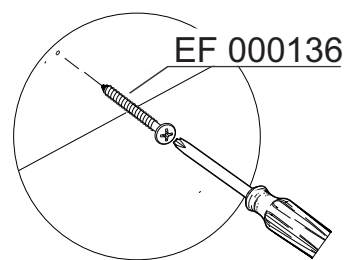
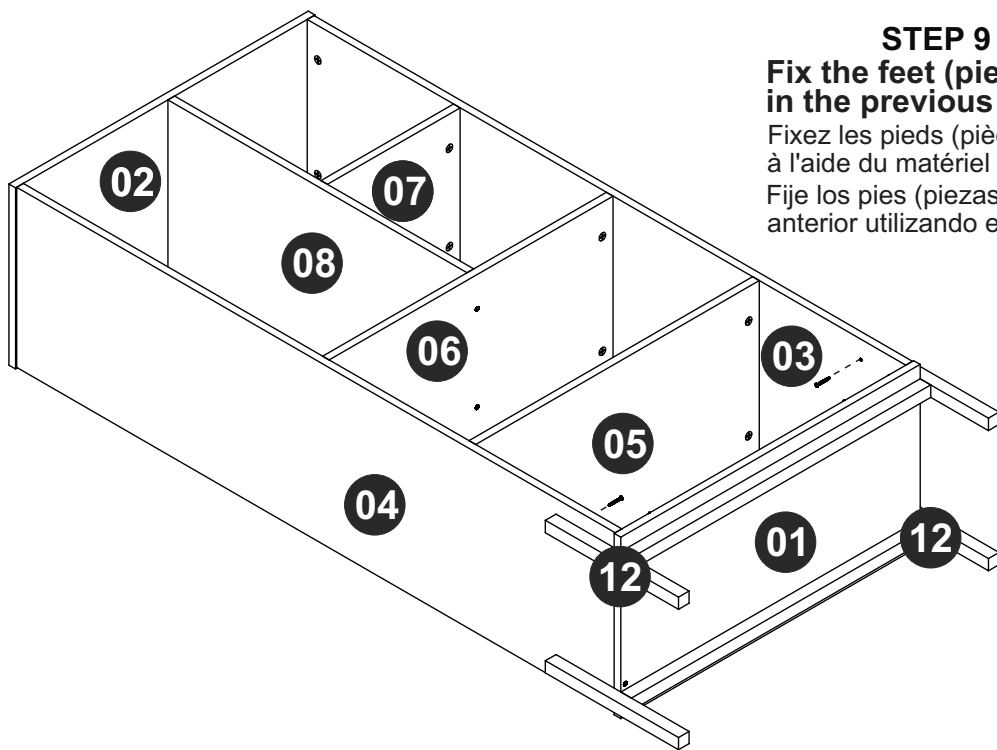

STEP 10 / ÉTAPE 10 / PASO 10

Fix pieces 10 and 11 to the furniture using hardware EF 000168.

Fixez les pièces 10 et 11 au produit à l'aide du matériel EF 000168.
Fije las piezas 10 y 11 al mueble utilizando el herraje EF 000168.

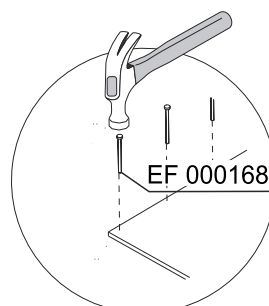
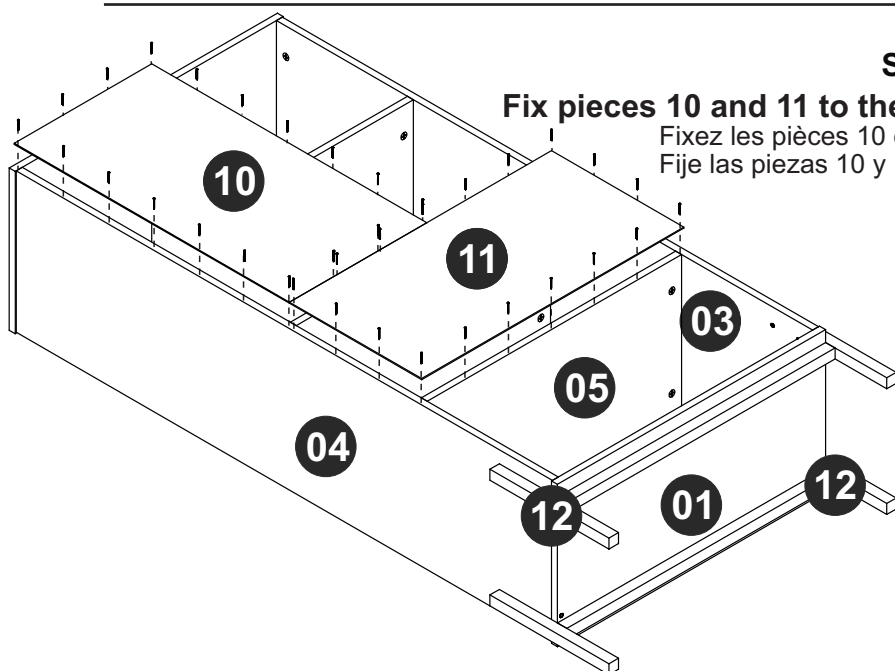

SCAN TO WATCH THE VIDEO
Scannez pour regarder la vidéo
Scanea para ver el vídeo



STEP 11 / ÉTAPE 11 / PASO 11

Fix piece 09 at the assembled furniture. Turn the screw for adjusting the door as needed.

Fixez le pièce 09 aux meubles assemblés.
 Tournez la vis pour régler la porte au besoin.
 Fije la pieza 09 al mueble armado.

Gire el tornillo para ajustar la puerta según sea necesario.

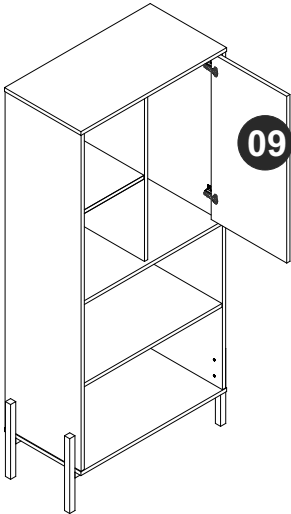

Depth adjusting
 réglage de la profondeur
 ajuste de profundidad

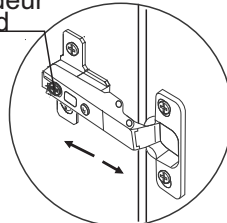

Vertical adjusting
 Réglage horizontal
 Ajuste horizontal

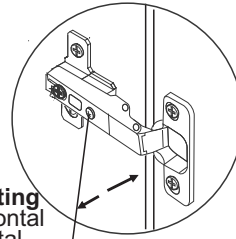

Vertical adjusting
 Réglage vertical
 Ajuste vertical

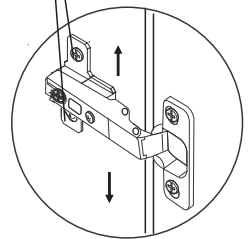

Release the screw for adjusting the door as needed.

Desserrez la vis pour régler la porte au besoin.

Release the screw for adjusting the door as needed.

STEP 12 / ÉTAPE 12 / PASO 12

Use hardware EF 000248 to fix the hardware EF 000529 to the furniture. Use hardware EF 000246 and EF 000016 for fixing the furniture to the wall.

Utilisez le matériel EF 000248 pour fixer le matériel EF 000529 au produit.
 Utilisez les ferrures EF 000246 et EF 000016 pour fixer le meuble au mur.
 Utilice el herraje EF 000248 para fijar el herraje EF000529 al mueble.
 Utilice los herrajes EF000246 y EF000016 para fijar el mueble en la pared.

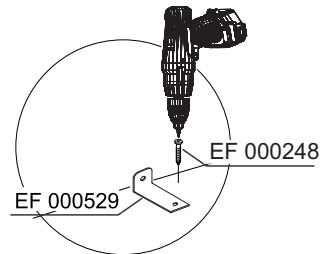
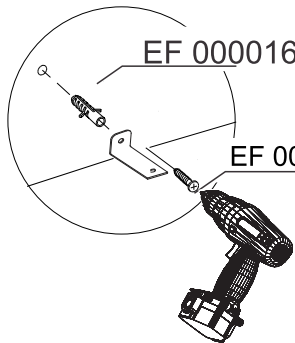
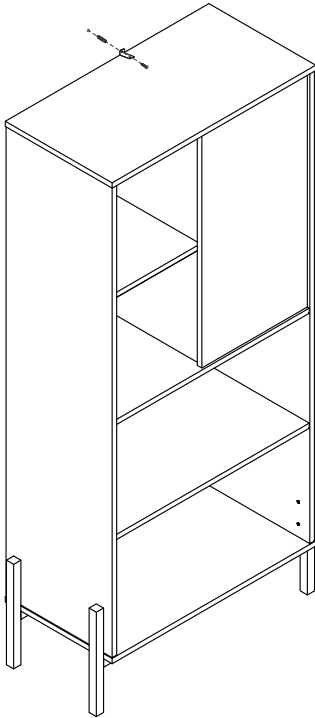

SCAN TO WATCH THE VIDEO
Scannez pour regarder la vidéo
Scanea para ver el vídeo



STEP 13 / ÉTAPE 13 / PASO 13

Use the chalk to give the final finish on the product. Use stickers to cover apparent screws.

Utilisez la craie pour terminer le produit. Utilisez l'adhésif pour couvrir les vis exposées.
 Utilice la tiza para dar el acabado final al producto. Utilice los tapa huecos para cubrir los tornillos aparentes.

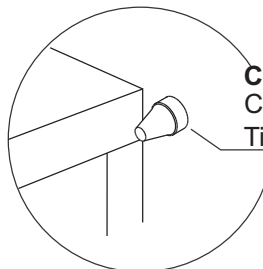
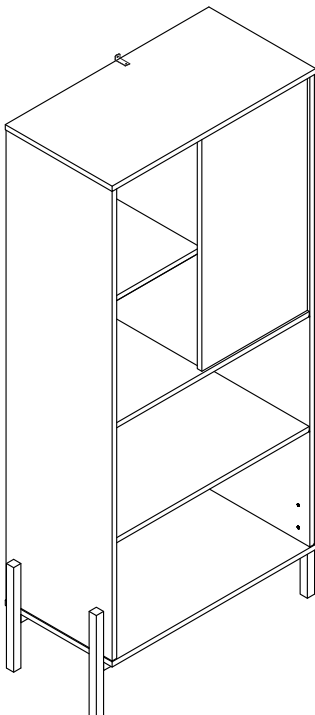

Chalk
 Craie
 Tiza

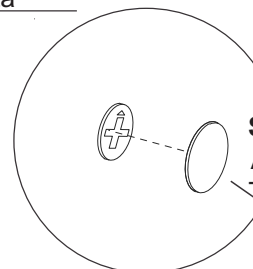

Sticker
 Adhésif
 Tapas Plásticas

