

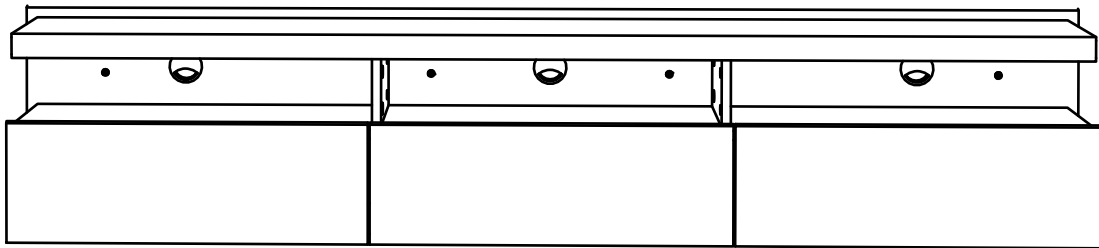

MANHATTAN  
COMFORT

## ASSEMBLY INSTRUCTIONS



COD:220300 CABRINI 2.2 WALL STAND

# IMPORTANT REMARKS



Never climb or lean on the furniture.  
You may suffer serious accidents.

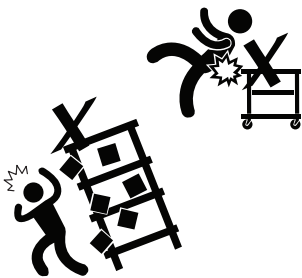

Use the packaging to cover the  
assembly area and separate  
all parts.

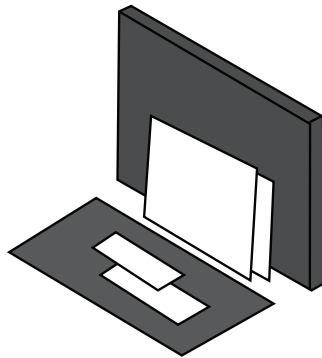

Identify the parts by observing the  
number printed on their edges.

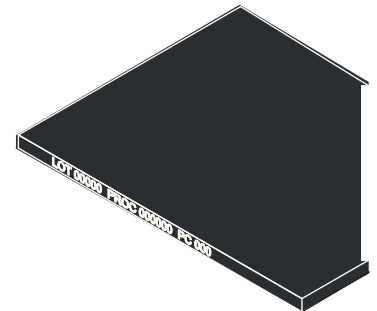

## CARE INSTRUCTIONS



Wipe clean using a damp cloth and a mild cleaner.  
Do not use abrasive and chemical products.



## HANDLING

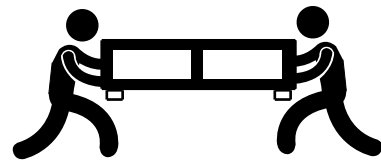

Move the piece carefully, don't drag it. Ask  
for someone else's help to do so.

# HARDWARE



Identify and separate the hardware used in the assembly. There's a label on each package identifying the parts and where to use them.

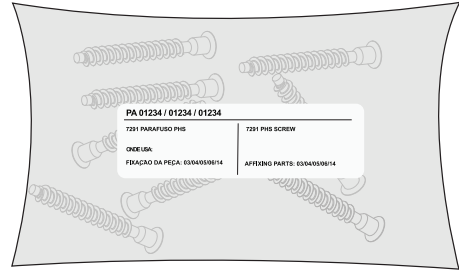

COD. 0599-12x



A

COD. 0494-12x



B

COD. 1533-24x



C

COD. 0160-12x



D

COD. 3557-09x

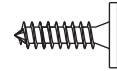

E

COD. 3706-06x

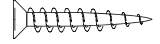

F

COD. 6533-12x



G

COD. 3527-37x



H

COD. 0338-06x



I

STICKER-12x

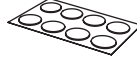

J

COD. 1668-54x



K

COD. 9070-08x

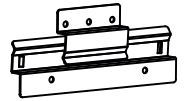

L

COD. 0348-01x



M

COD. 4157-16x

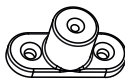

N

COD. 2088-10x



O

COD. 4505-04x



P

COD. 6244-06x



Q

COD. 2661-03x

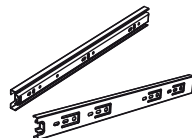

R

WIRE CHANNEL-03x

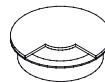

S

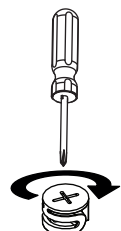
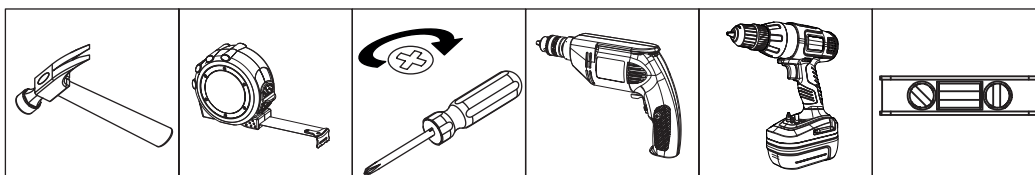

# DESCRIPTION

W:85.63 inches H:14.96 inches D: 17.12 inches  
 L:2175mm A:380mm P:435 mm

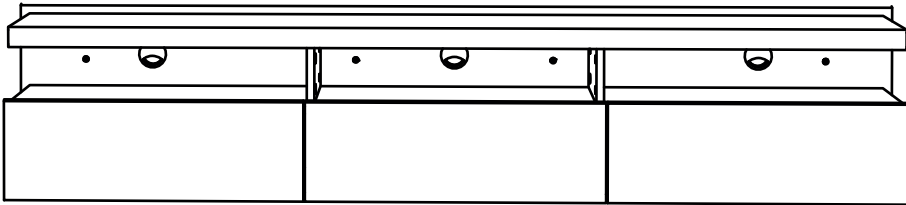

CÓD:220300			
PART	QUANTITY	DESCRIPTION	BOX
22	01	TOP BOARD	01
23	01	CENTER BOARD	01
24	01	BOTTOM BOARD	01
25	02	UPPER DIVIDER	01
26	02	BOTTOM DIVIDER	02
27	01	LEFT SIDE	01
28	01	RIGHT SIDE	01
37	03	DRAWER FRONT	01
38	06	DRAWER SIDE	02
39	06	DRAWER BACK PANEL	02
40	03	DRAWER BOTTOM	02
41	01	BACKPLATE	01
42	02	SIDE BATTEN	01

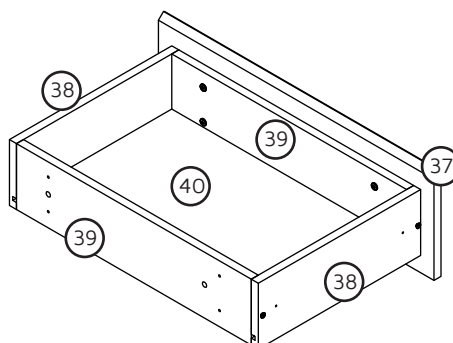
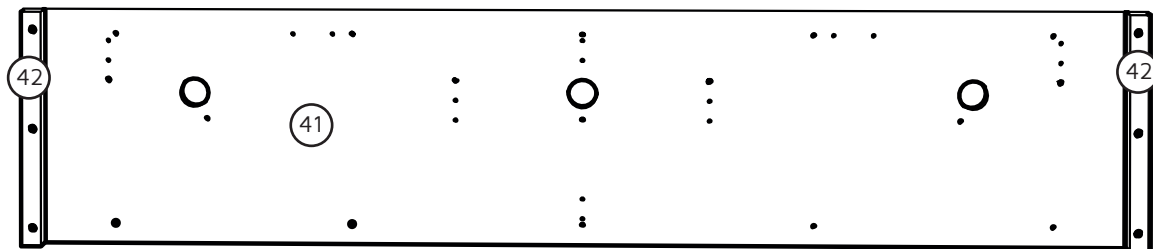
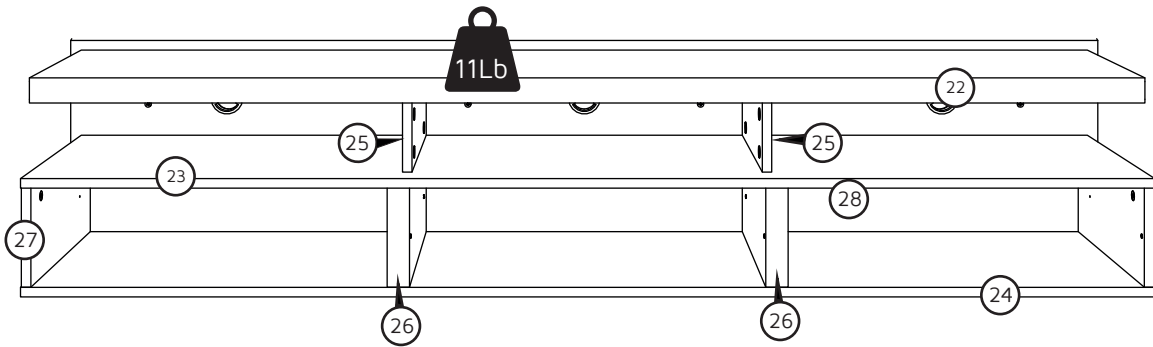



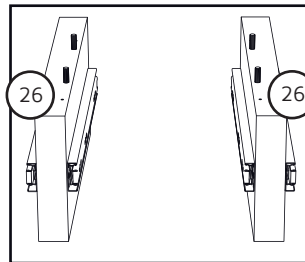
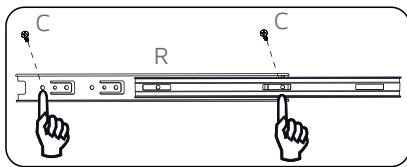
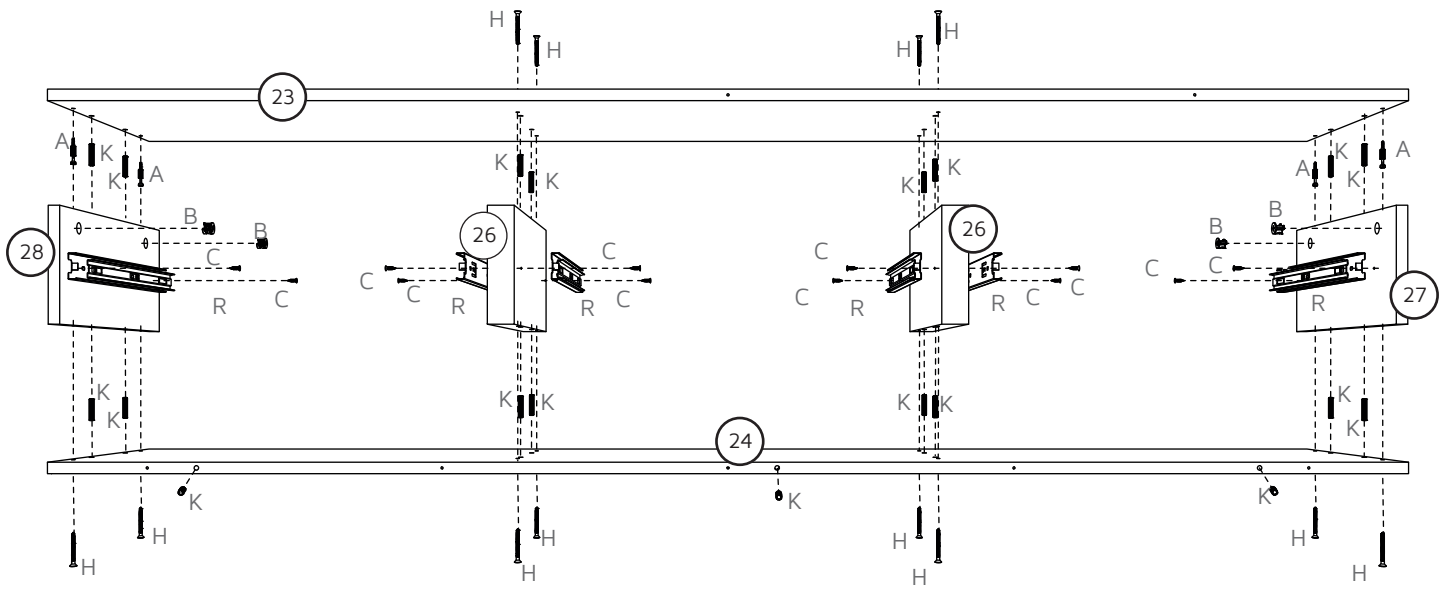
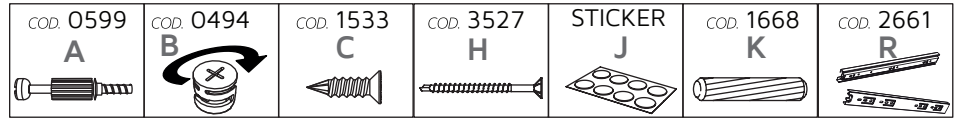

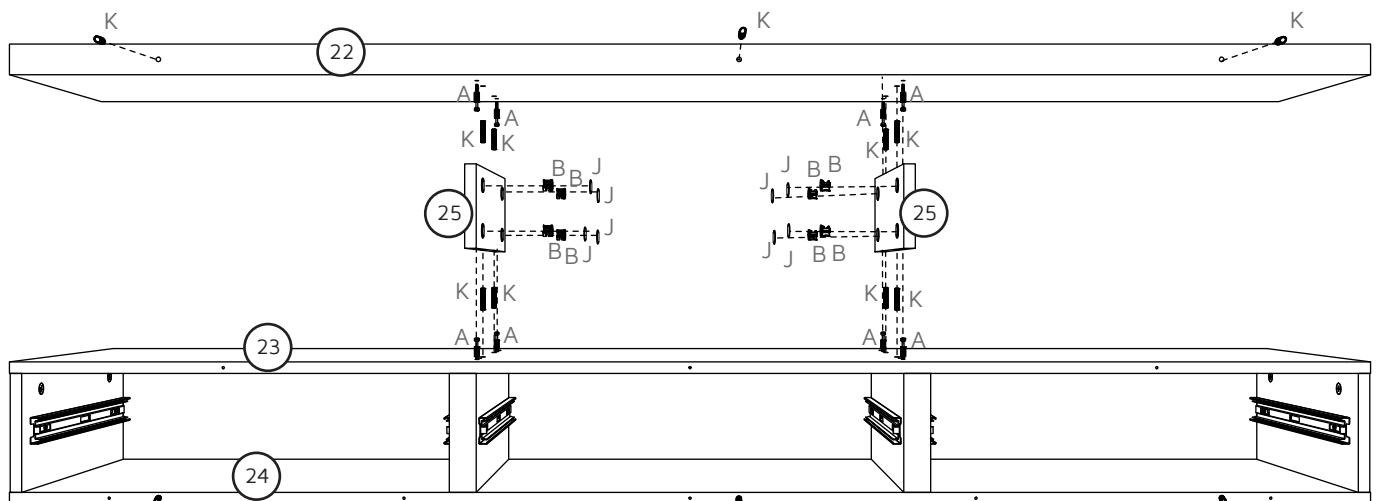

01



02



03



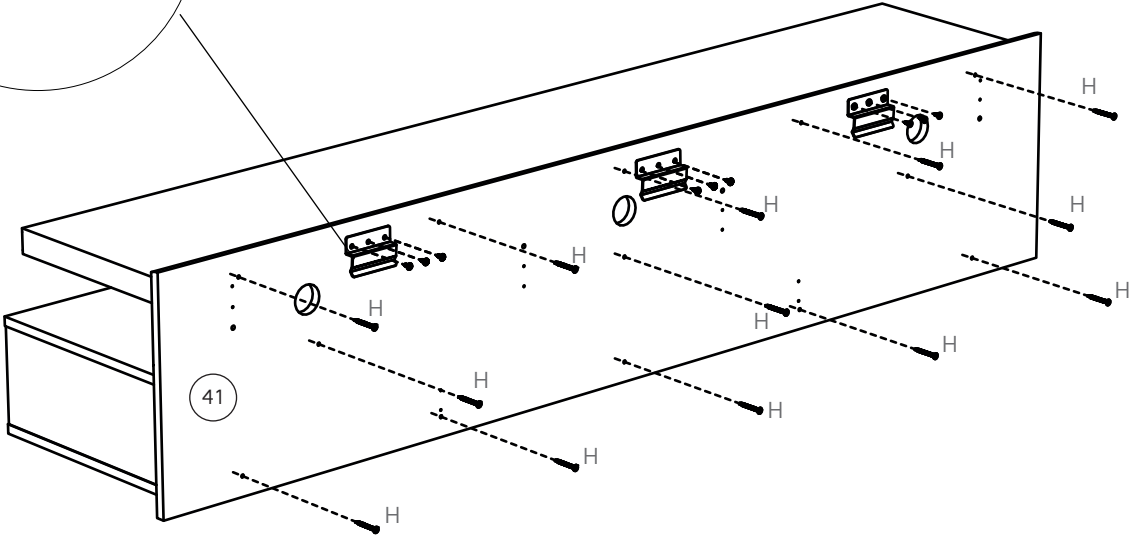
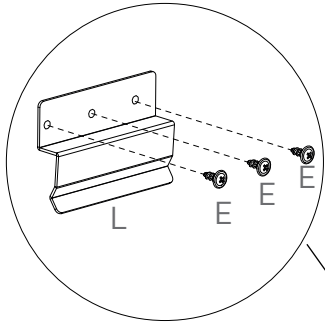



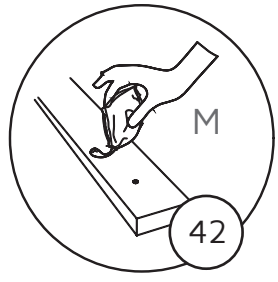
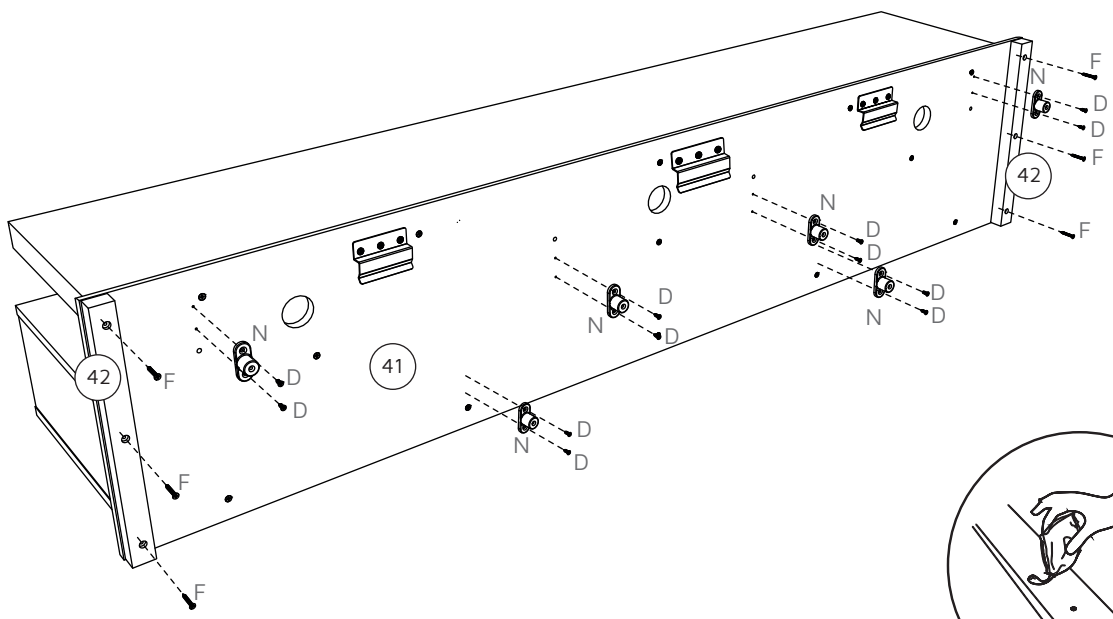

COD. 0160 <b>D</b> 	COD. 3557 <b>E</b> 	COD. 3706 <b>F</b> 	COD. 3527 <b>H</b> 	COD. 9070 <b>L</b> 	COD. 0348 <b>M</b> 	COD. 4157 <b>N</b> 
---	---	---	--	---	---	---



04

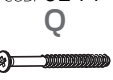

Use the PVA glue before screwing.

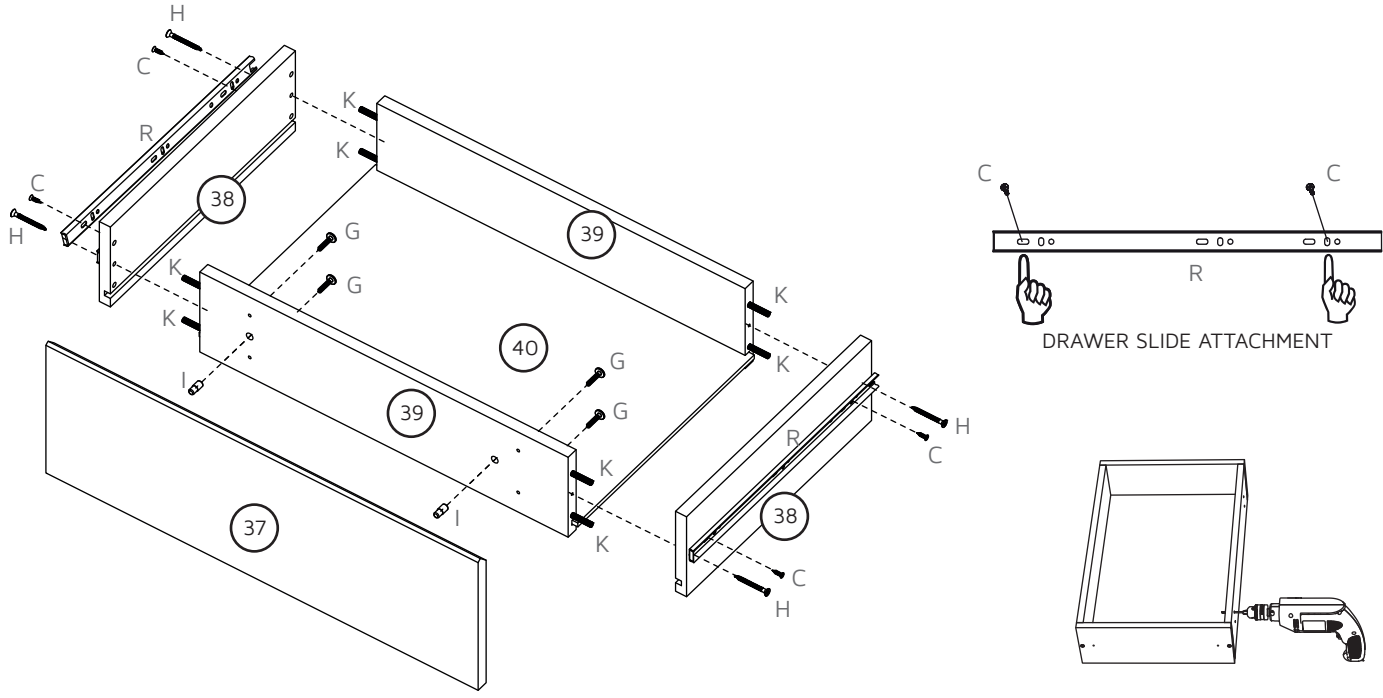

COD. 1533 <b>C</b> 	COD. 6533 <b>G</b> 	COD. 3527 <b>H</b> 	COD. 0338 <b>I</b> 	COD. 1668 <b>K</b> 	COD. 9070 <b>L</b> 	COD. 2088 <b>O</b> 	COD. 6244 <b>Q</b> 	COD. 2661 <b>R</b> 
---	---	---	---	---	--	---	---	---

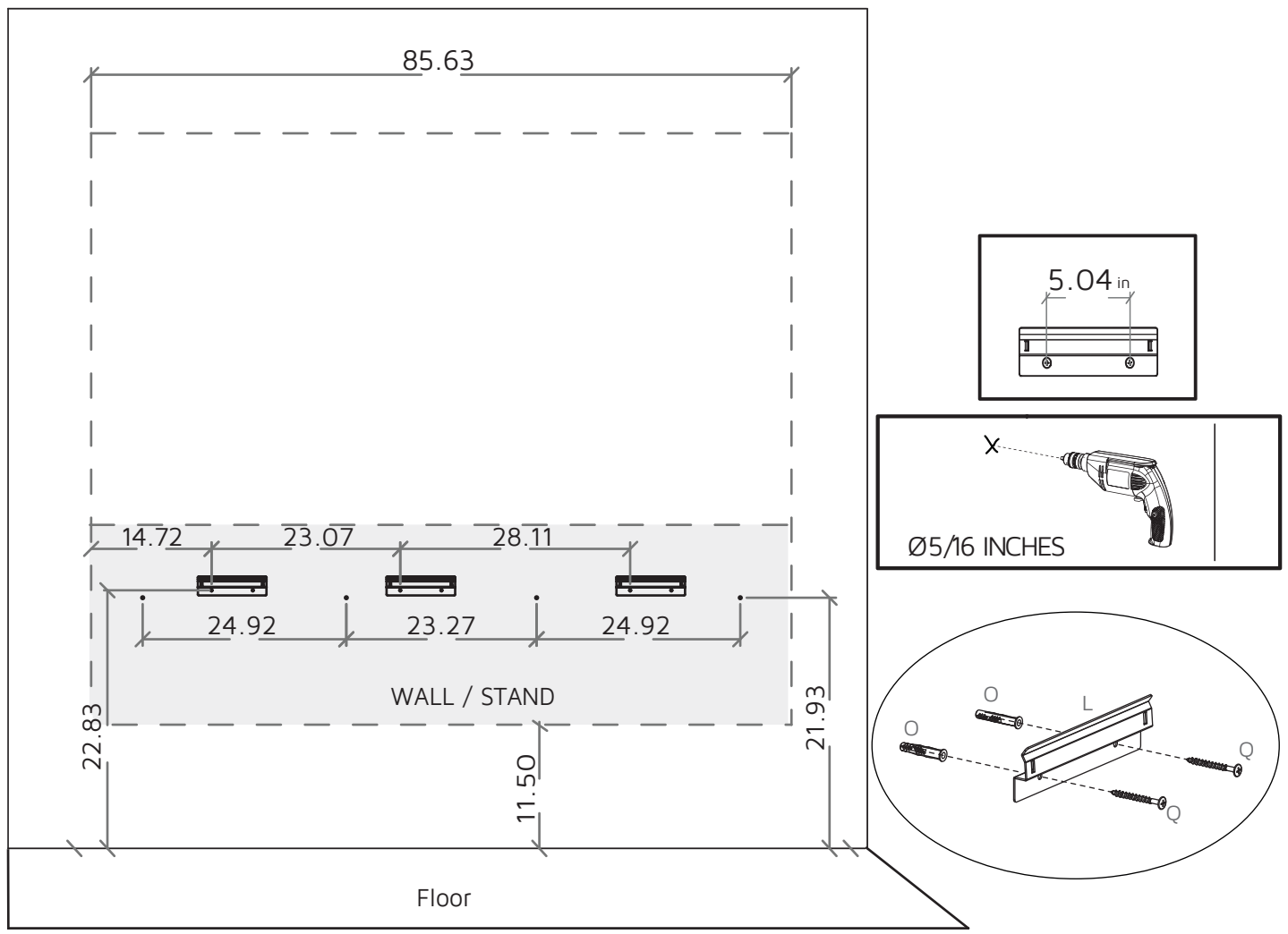

### Measurement to drill the wall.



07

COD. 4505	STICKER	WIRE CHANNEL
P	J	S
		

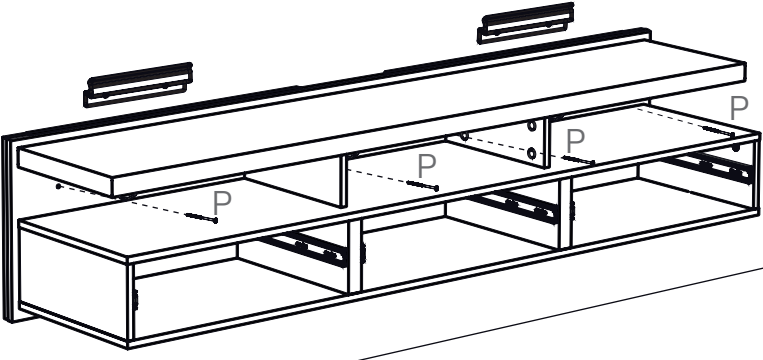

**ATTENTION**  
Pass the cables through the wire channel  
before screwing (P)

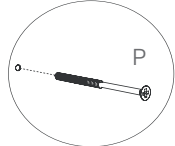
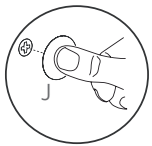

SAFETY SCREW

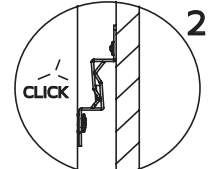
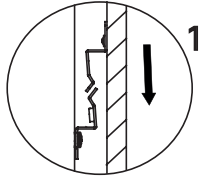

08

DETAIL

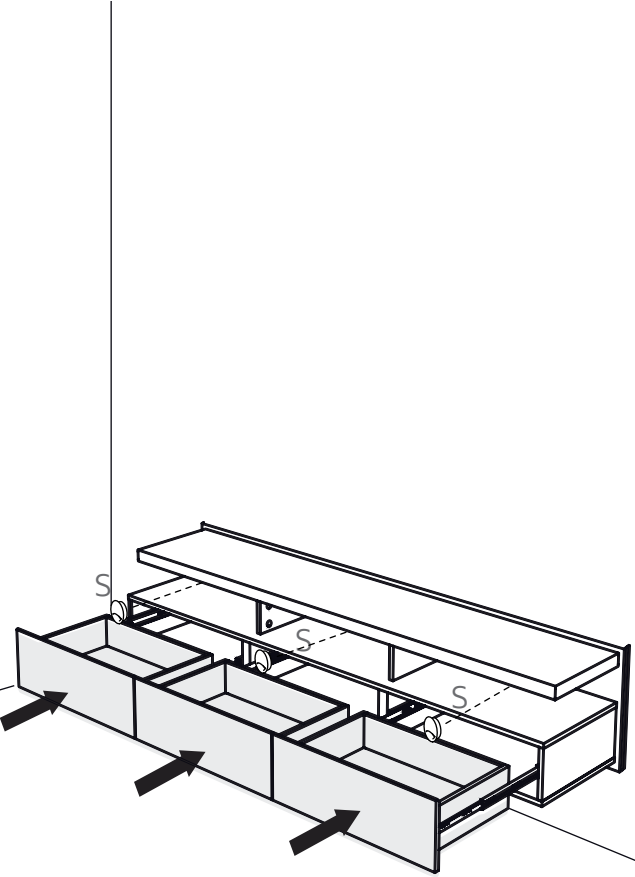
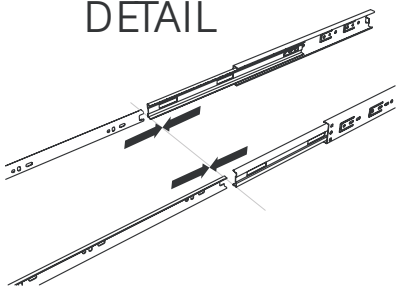

08