

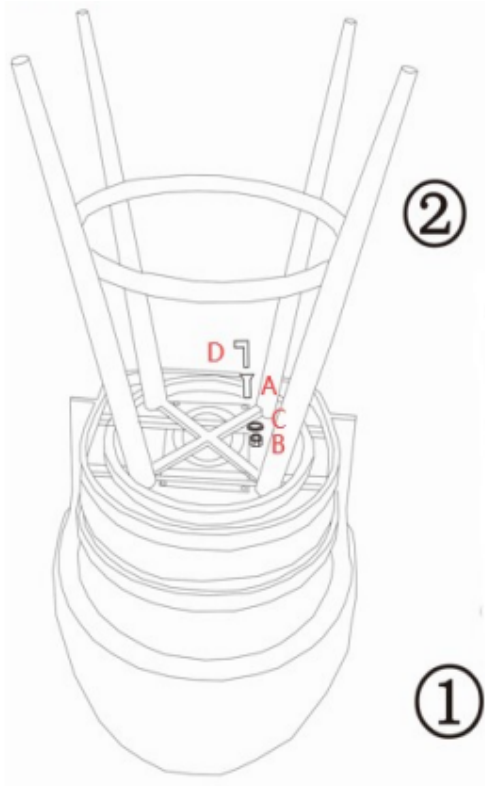





Product Assembly Instructions

Item#: Justin Swivel Barstool

Helpers needed to assemble: 2

Estimate time frame to assemble: 20 minutes



#	Picture	Description	Quantity
1		Seat	1
2		Frame	1
A		Bolts(M6x25)	4
B		Nut	4
C		Washer	4
D		Allen Key	1

- **Step 1** : Place the barstool seat upside down on the floor as seen.
- **Step 2** : Align the barstool legs with the barstool seat holes
- **Step 3** : Please the washer on the screw followed by the nut and proceed to enter the chair and leg insert.
- **Step 4**: Using the Allen key tighten the screw, until it is firm and doesn' t move.
 - Repeat steps 3 and 4 for each leg.



- **Step 5**: Flip the barstool over upright as seen.
- **Step 6**: Test the barstool is firmly on the ground and the seat does not wiggle.
- **Step 7**: Sit and enjoy your new barstool.

Keep the Allen Key and tighten all screws every three months.