







# Product Assembly Instructions

## Item#: Chelsea Swivel Barstool

Helpers needed to assemble: 2

Estimate time frame to assemble: 20 minutes

| # | Picture   | Description  | Quantity |
|---|---|--------------|----------|
| 1 |  | Seat         | 1        |
| 2 |  | Frame        | 1        |
| A |  | Bolts(M6x25) | 4        |
| B |  | Nut          | 4        |
| C |  | Washer       | 4        |
| D |  | Allen Key    | 1        |

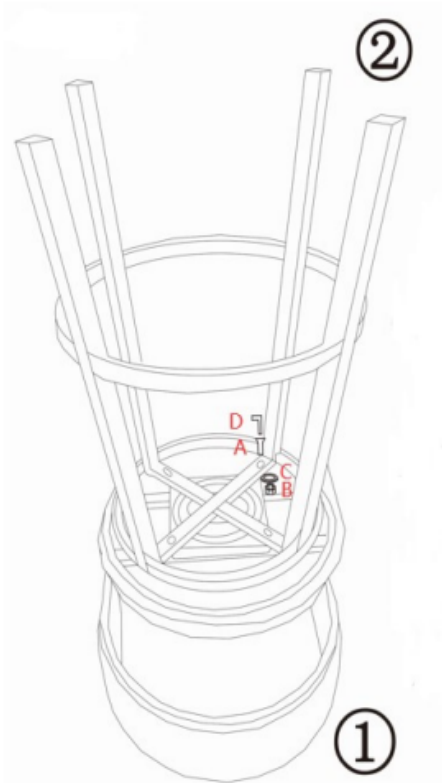

- **Step 1** :Place the barstool seat upside down on the floor as seen.
- **Step 2** :Align the barstool legs/frame with the barstool seat holes.
- **Step 3** :Place the washer on the screw followed by the nut and proceed to enter the chair and leg insert.
- **Step 4**: Using the Allen Key tighten the screw, until it is firm and doesn' t move.
  - Repeat steps 3 and 4 for each leg.



- **Step 5**: Flip the barstool over upright as pictured.
- **Step 6**: Test the barstool is firmly on the ground and the seat does not wiggle.
- **Step 7**: Sit and enjoy your new barstool.

**\*Keep the Allen Key and tighten all screws every three months.**