

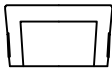





# Assembly Instruction

Item No: 89720-C/89721-C

## COMPONENT LIST

NO.	DRAWING	QTY	NO.	DRAWING	QTY
A		1	B		1
C		1	D		1
E		1	F		4
G		16	H		1

STEP1. Back Cushion (E) 、 Backrest (B) 、 Legs (F) And Hardware(G/H) Under The Seat.

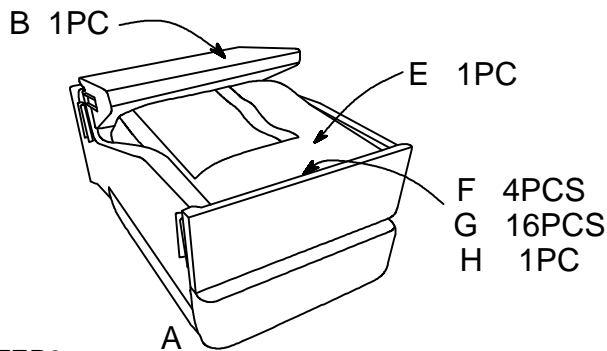

STEP2.

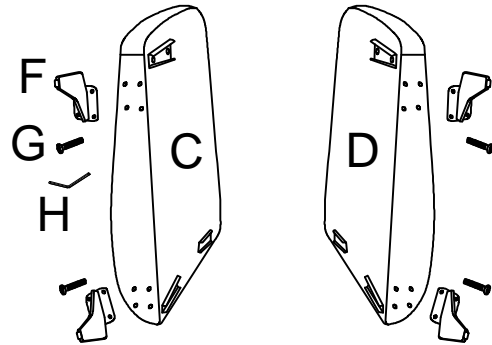

STEP3.

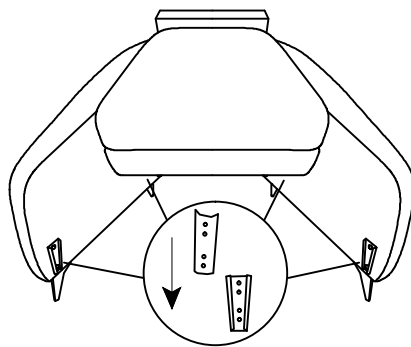

STEP4.

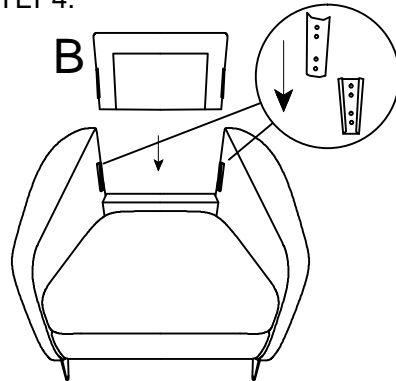

STEP5.

