

Ax1

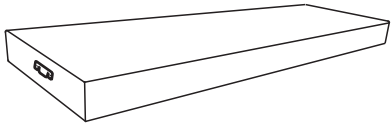

Bx2

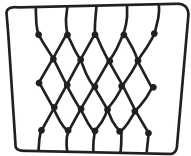

Cx1



Dx1



Ex1



Fx3



Gx2

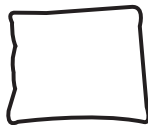

Hx1



Ix4

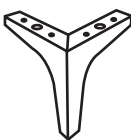

Jx8



Kx1

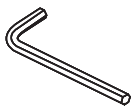

1

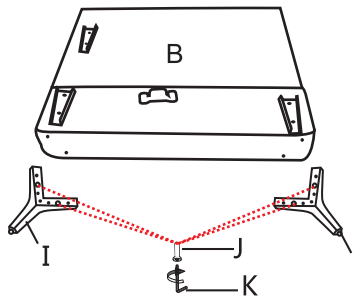
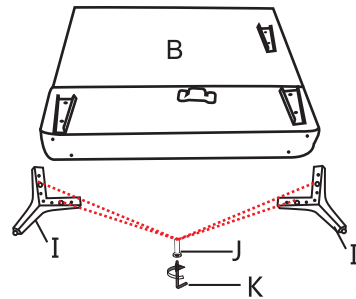

2

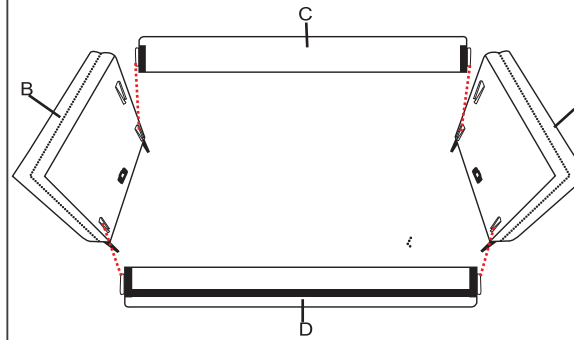

3

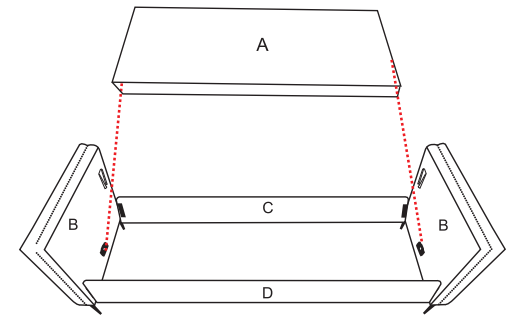

4

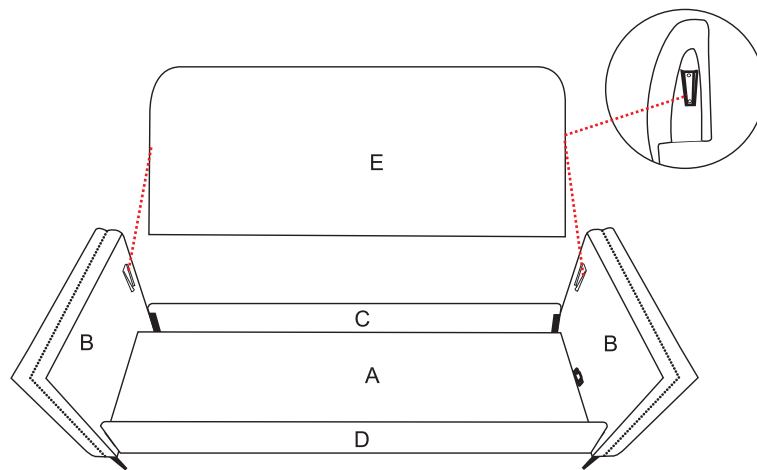

5

