

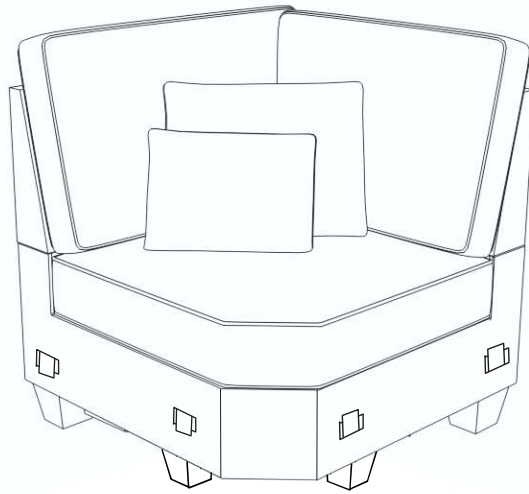







ASSEMBLY INSTRUCTION

ITEM NO: 89131-C/89132-C/89133-C



PARTS LIST

| | | | | |
|--|---|---|---|--|
|  |  |  |  |  |
| A x1 | B x1 | C x1 | D x1 | E x1 |
|  |  |  | | |
| F x1 | G x1 | H Leg x5 | | |

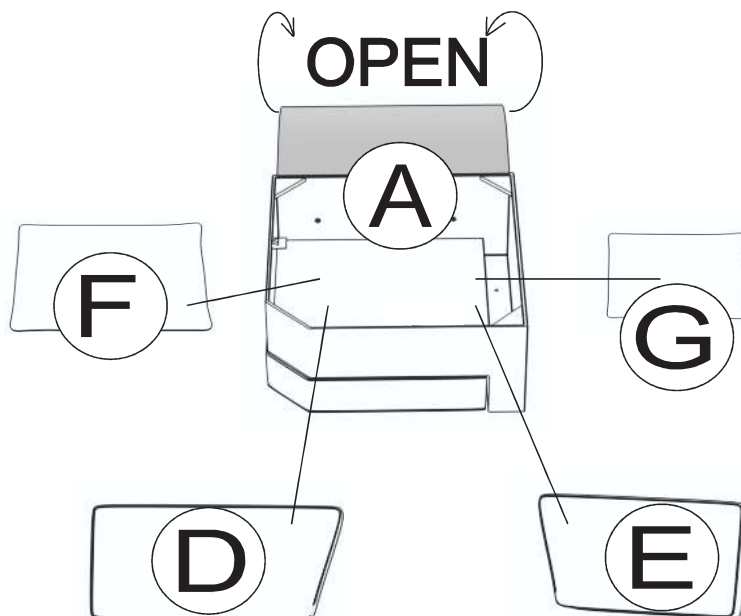

Step 1

