

ASSEMBLY INSTRUCTION

ITEM NO: 87800

Please choose the **CHAISE** will be on the **LEFT** or **RIGHT** hand side

CHAISE ON THE LEFT

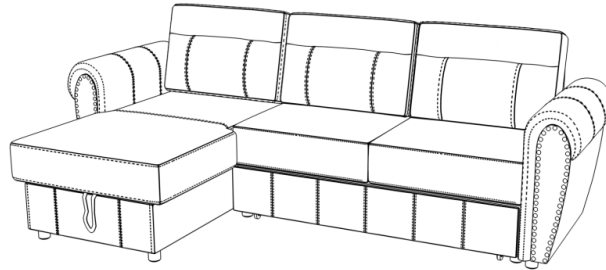

PARTS LIST

BOX-1

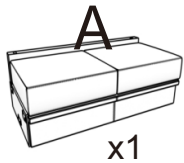

BOX-2

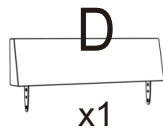
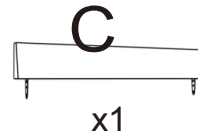
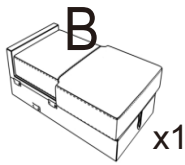

BOX-3

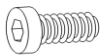
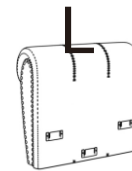

1

x8



2

x4



3

x1



4

x12

BEFORE ASSEMBLY

Open up **(BOX-1) (BOX-2)** Velcro of Non-Woven Fabric cover on the bottom of the seat frame to remove **back cushions, hardwares** and **legs**.

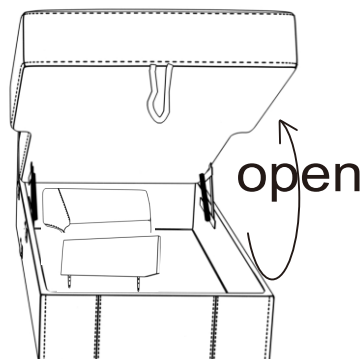
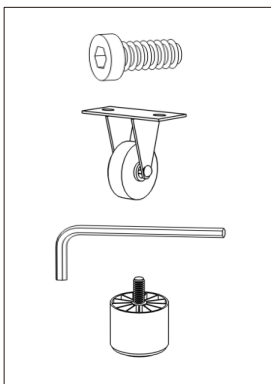

Please check all components before assembly ,Thanks.

CHAISE ON THE LEFT

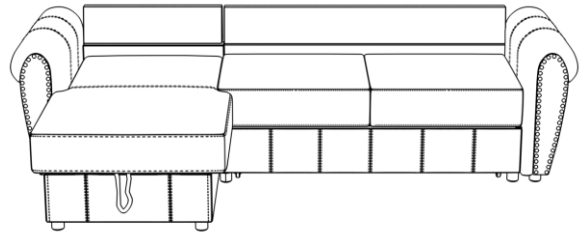
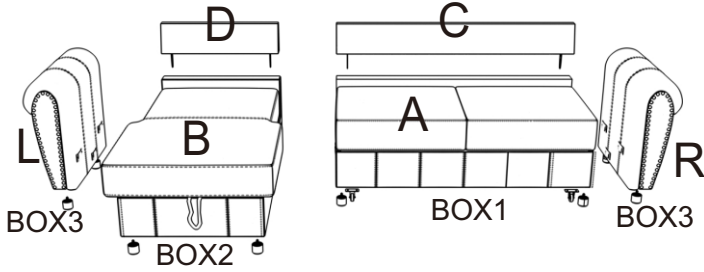

ASSEMBLY INSTRUCTION

Step1

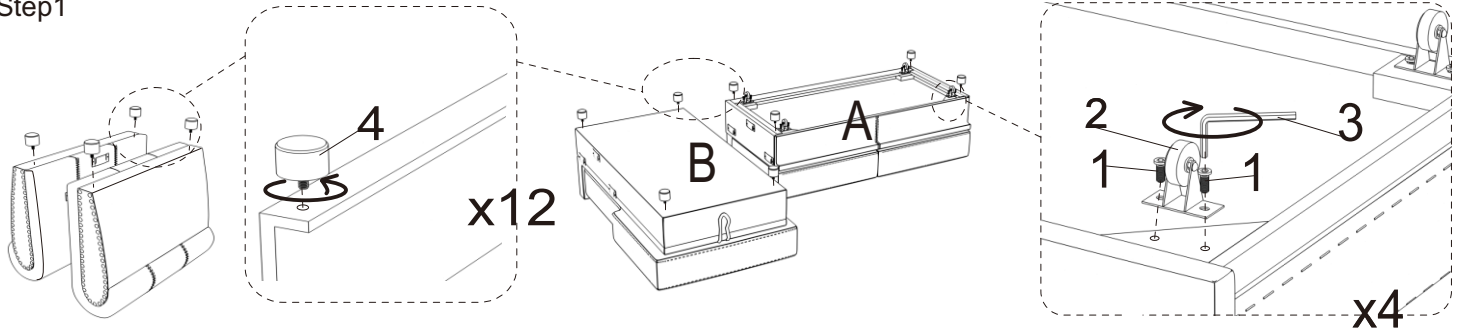

Step2

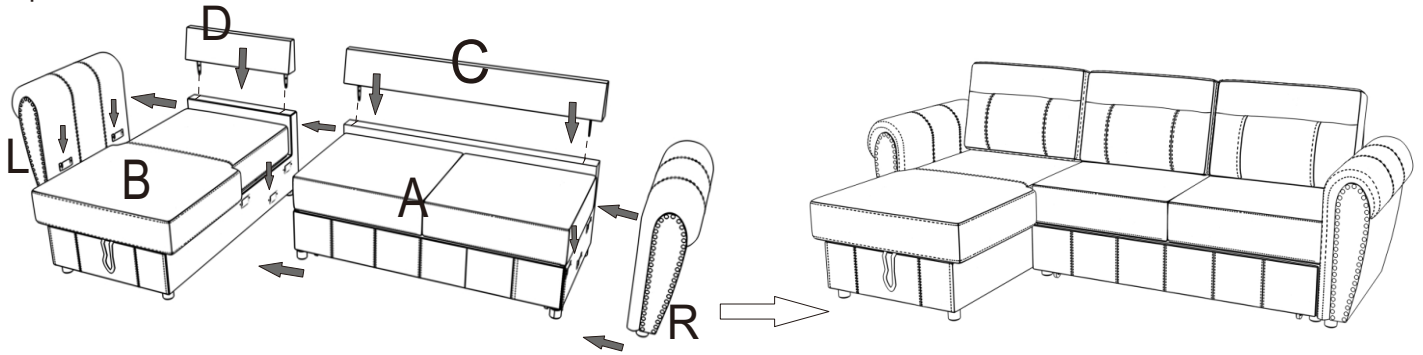

Step3

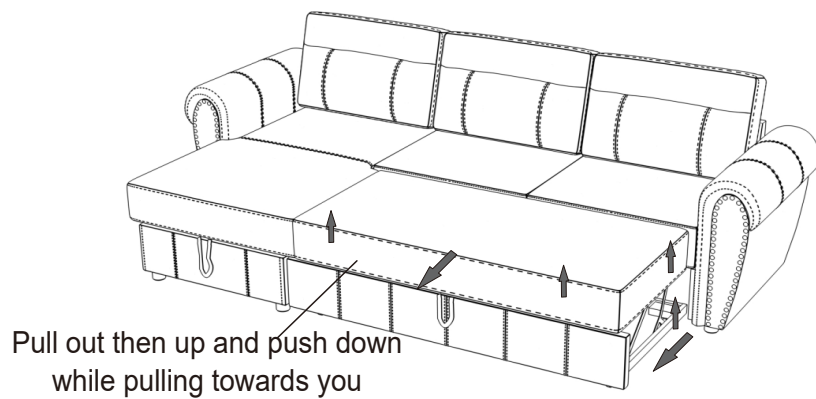

Step4

