

ASSEMBLY INSTRUCTION

ITEM NO.: 81804-A

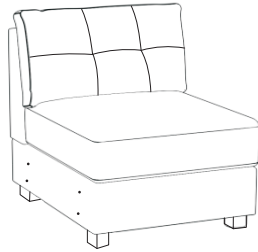

PARTS LIST

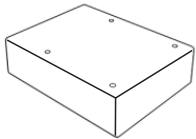

A

x1

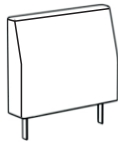

B

x1



D

Leg

x4



5

x2

Open up Velcro of Non-Woven Fabric cover on the bottom of the seat frame to remove **seat cushions, Back cushions and legs.**

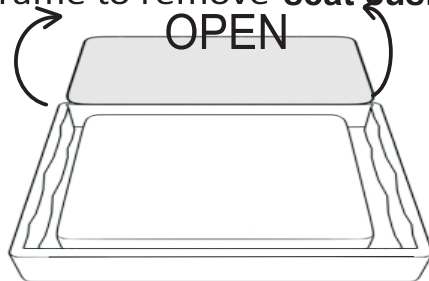

ASSEMBLY INSTRUCTION

Step1

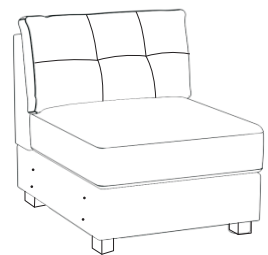
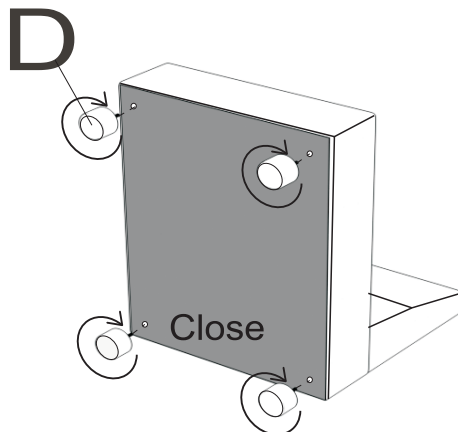
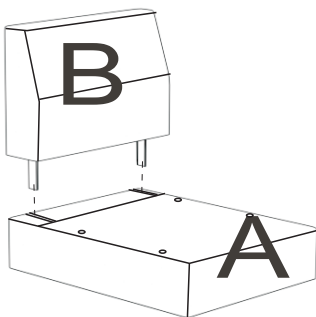



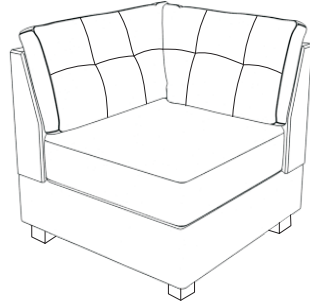

ASSEMBLY INSTRUCTION

ITEM NO.: 81804-C

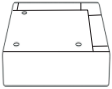

PARTS LIST

									
A	x1	B	x1	C	x1	D Leg	x4	5	x2

Open up Velcro of Non-Woven Fabric cover on the bottom of the seat frame to remove **seat cushions, Back cushions and legs.**

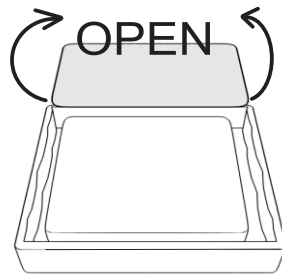

Step1

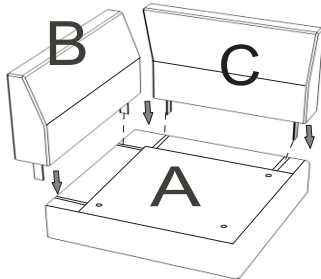

Step2

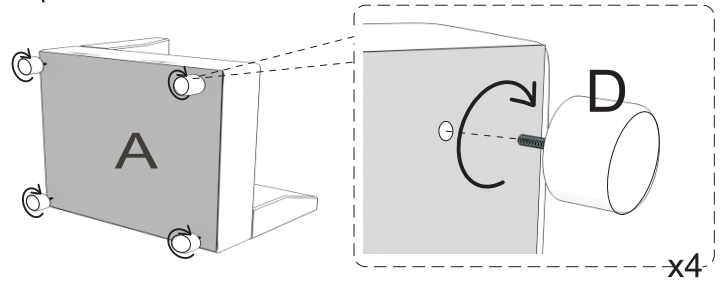

Step3

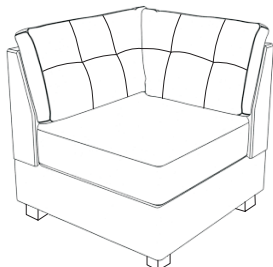

ASSEMBLY INSTRUCTION

ITEM NO.: 81804-LS

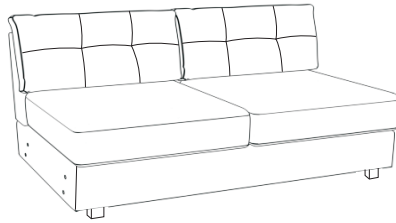

PARTS LIST

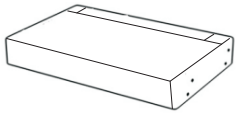

A

x1



B

x1



D Leg

x4



5

x2

Open up Velcro of Non-Woven Fabric cover on the bottom of the seat frame to remove **seat cushions, Back cushions and legs**

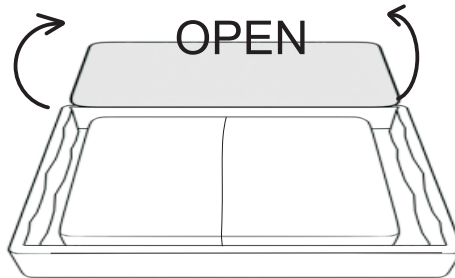

2-SEAT ASSEMBLY INSTRUCTION

Step1

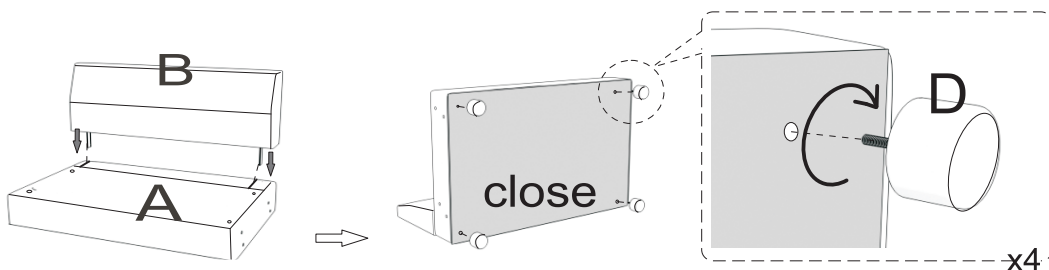

81804-LS

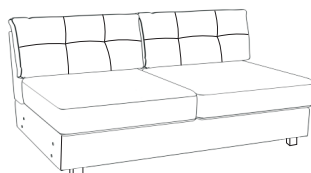

ASSEMBLY INSTRUCTION

ITEM NO.: 81804-ARM

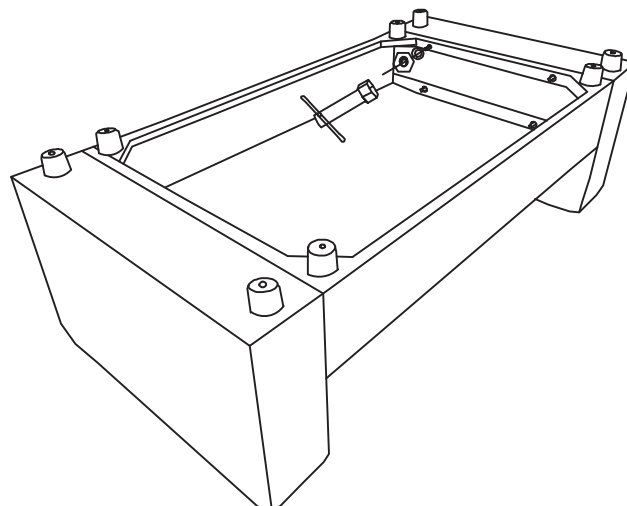
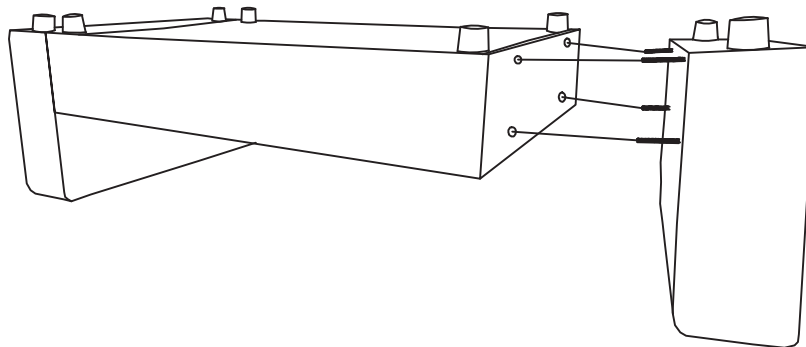
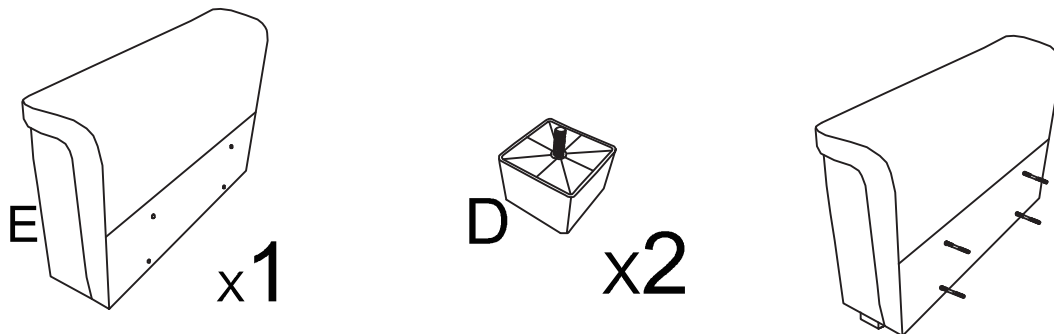

1

x4



2

x4



3

x4

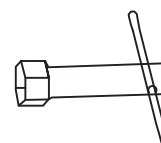

4

x1

ASSEMBLY INSTRUCTION

ITEM NO.: 81804-0

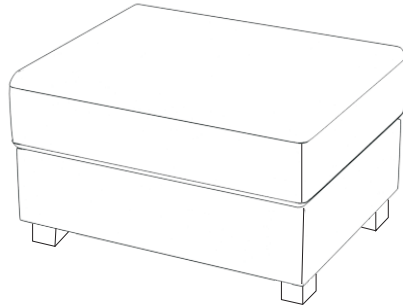

PARTS LIST

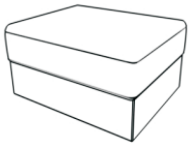

A

x1

D

Leg

x4

5

x2

Step1

