

# ASSEMBLY INSTRUCTION

ITEM NO.: 81803-LS

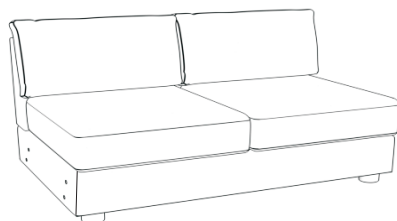

## PARTS LIST

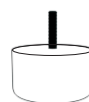
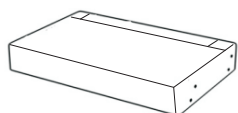

**A**

x1

**B**

x1

**D**

Leg

x4

**5**

x2

Open up Velcro of Non-Woven Fabric cover on the bottom of the seat frame to remove **seat cushions, Back cushions and legs**

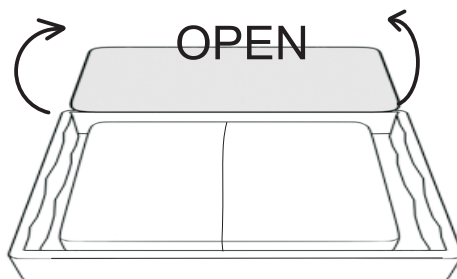

## 2-SEAT ASSEMBLY INSTRUCTION

Step1

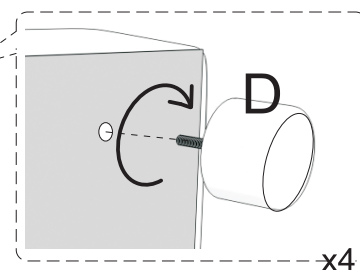
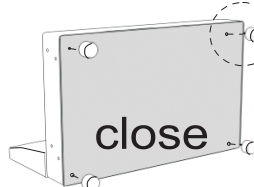
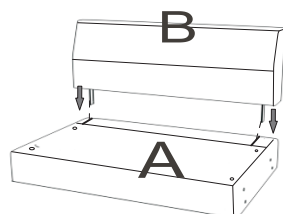

81803-LS

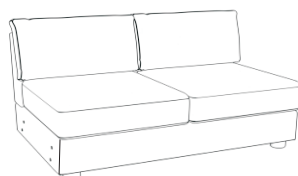

# ASSEMBLY INSTRUCTION

ITEM NO.: 81803-A

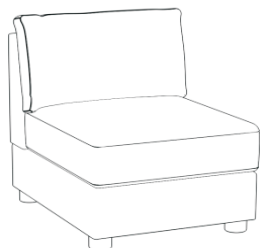

## PARTS LIST

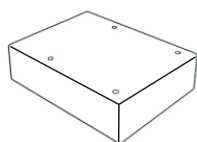

**A**

x1

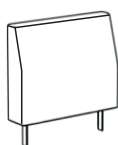

**B**

x1



**D**

Leg

x4



**5**

x2

Open up Velcro of Non-Woven Fabric cover on the bottom of the seat frame to remove **seat cushions, Back cushions** and **legs**.

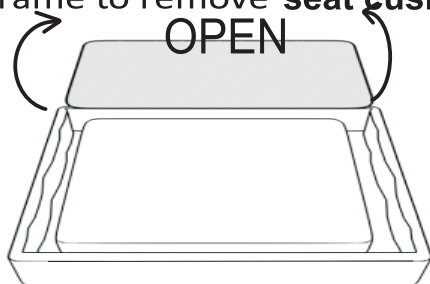

## ASSEMBLY INSTRUCTION

Step1

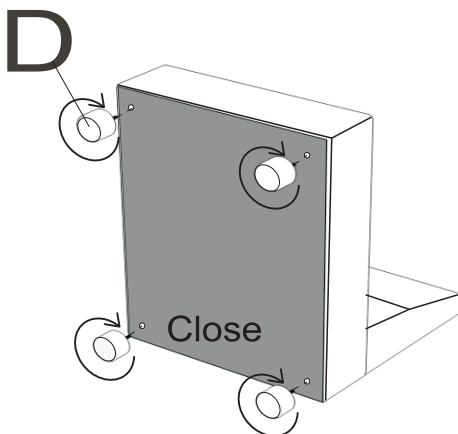
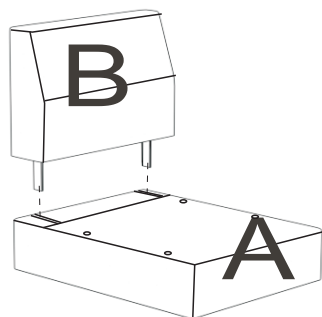

# ASSEMBLY INSTRUCTION

ITEM NO.: 81803-CH

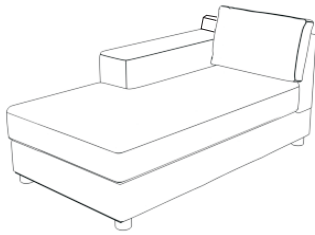

81803-CH

LEFT

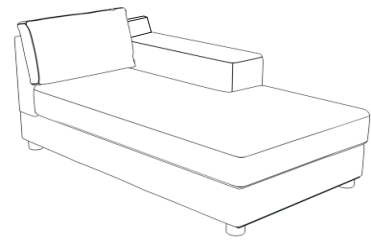

81803-CH

RIGHT

## PARTS LIST

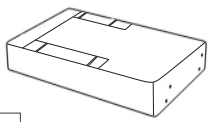

A

x1



B

x1



C

x1



D

Leg

x4

Open up Velcro of Non-Woven Fabric cover on the bottom of the seat frame to remove **seat cushions, back cushions and legs**



## LEFT CHAISE ASSEMBLY INSTRUCTION

Step1

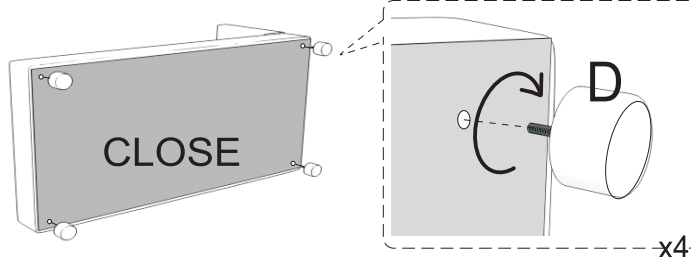
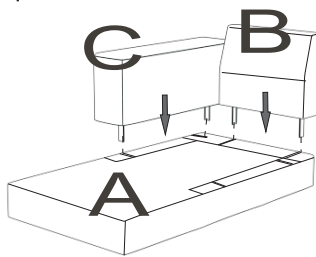

81803-CH

LEFT

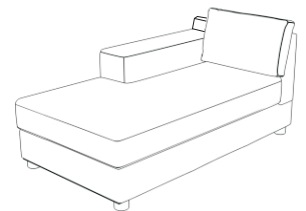

## RIGHT CHAISE ASSEMBLY INSTRUCTION

Step1

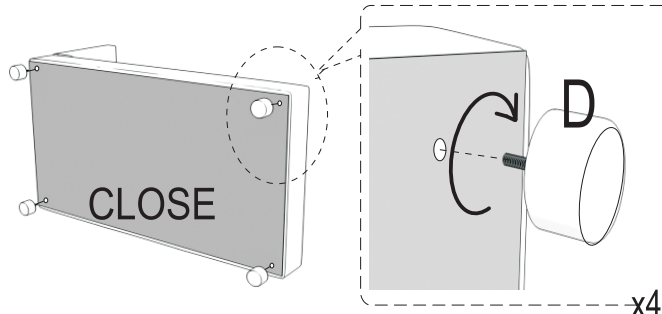
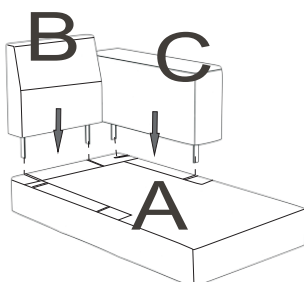

81803-CH

RIGHT

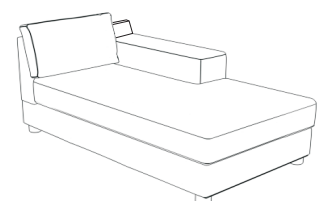

# ASSEMBLY INSTRUCTION

ITEM NO.: 81803-ARM

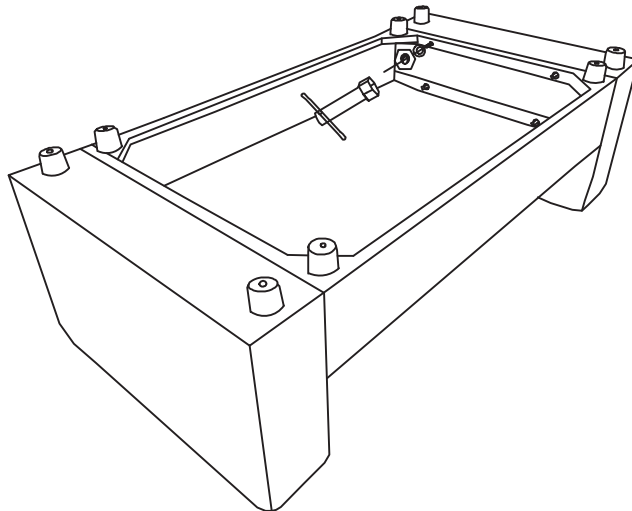
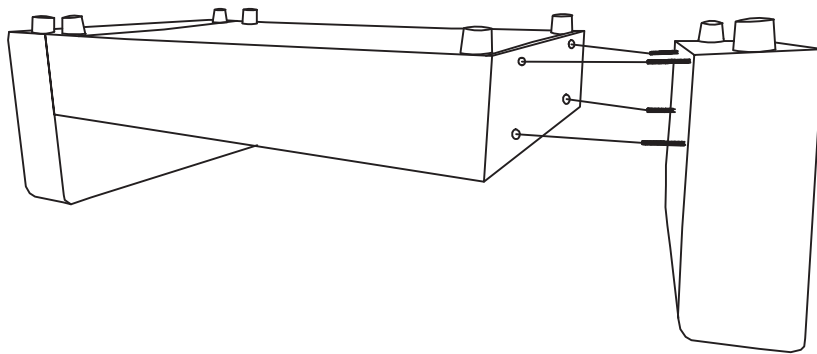
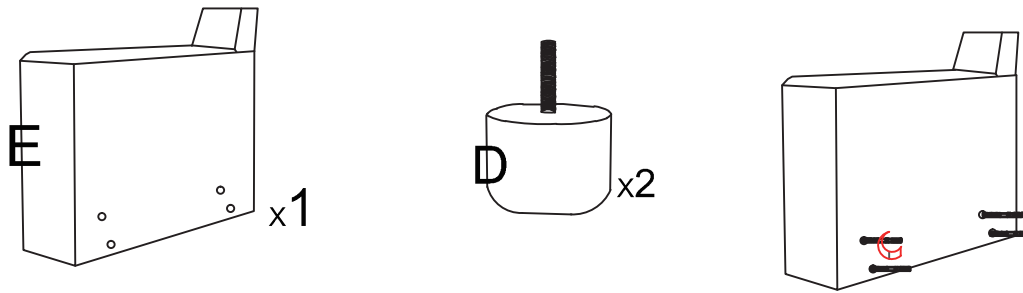

1

x4



2

x4



3

x4

4

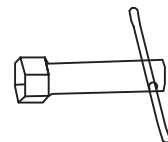

x1