

# ASSEMBLY INSTRUCTION

ITEM NO.: 81803-LS

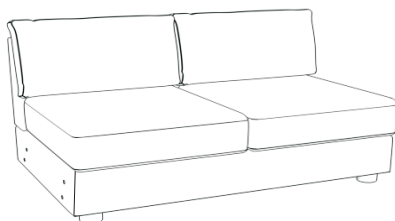

## PARTS LIST

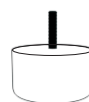
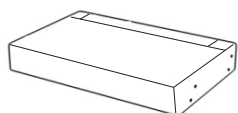

**A**

x1

**B**

x1

**D**

Leg

x4

**5**

x2

Open up Velcro of Non-Woven Fabric cover on the bottom of the seat frame to remove **seat cushions, Back cushions and legs**

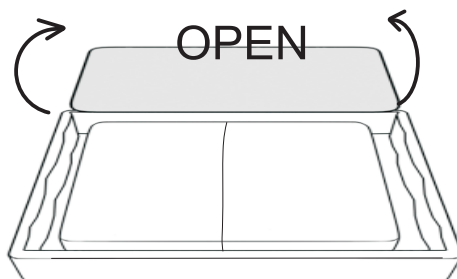

## 2-SEAT ASSEMBLY INSTRUCTION

Step1

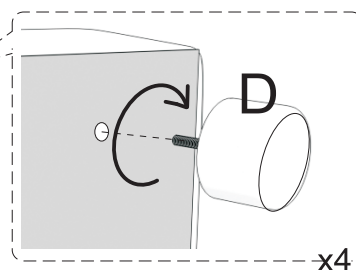
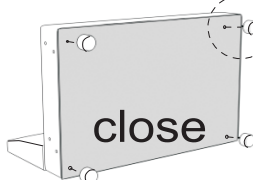
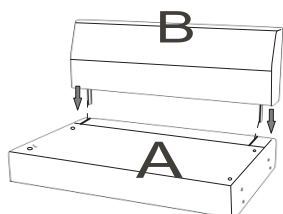

81803-LS

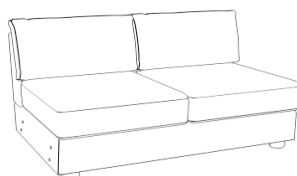

# ASSEMBLY INSTRUCTION

ITEM NO.: 81803-A

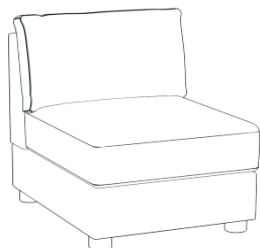

## PARTS LIST

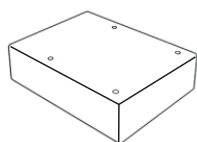

**A**

x1

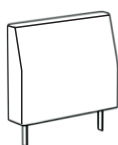

**B**

x1

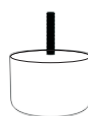

**D**

Leg

x4



**5**

x2

Open up Velcro of Non-Woven Fabric cover on the bottom of the seat frame to remove **seat cushions, Back cushions and legs.**

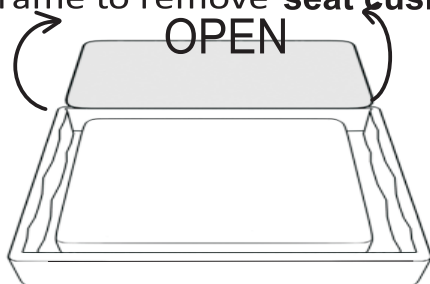

## ASSEMBLY INSTRUCTION

Step1

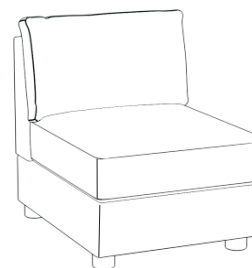
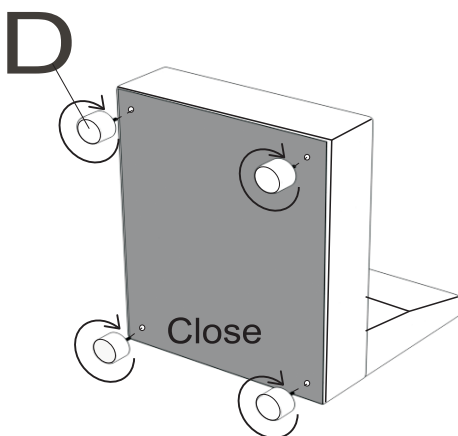
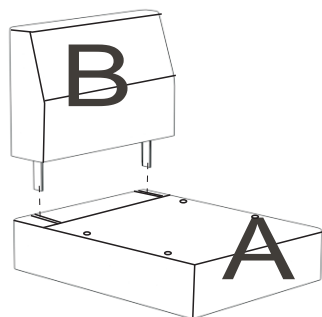



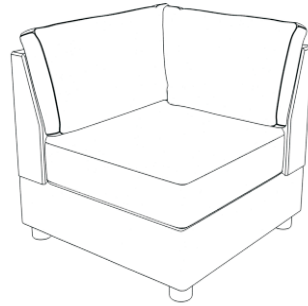

# ASSEMBLY INSTRUCTION

ITEM NO.: 81803-C

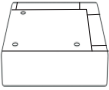

## PARTS LIST

										
<b>A</b>	x1	<b>B</b>	x1	<b>C</b>	x1	<b>D</b>	Leg	x4	<b>5</b>	x2

Open up Velcro of Non-Woven Fabric cover on the bottom of the seat frame to remove **seat cushions, Back cushions and legs.**

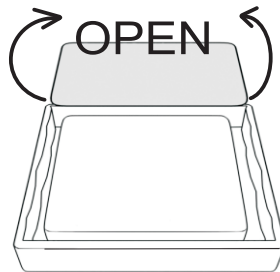

Step1

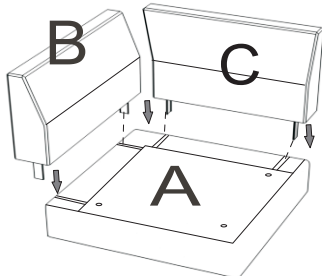

Step2

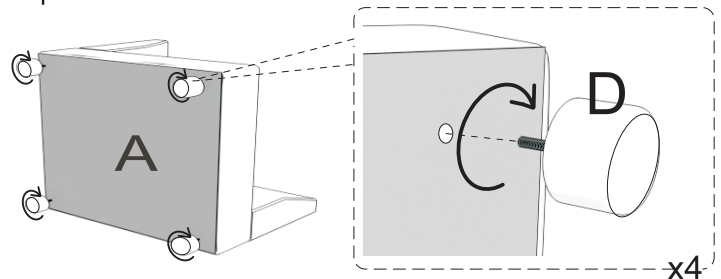

Step3

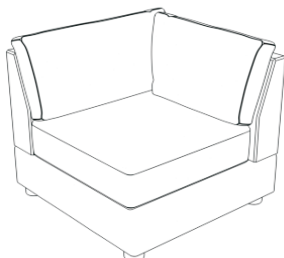

# ASSEMBLY INSTRUCTION

ITEM NO.: 81803-O

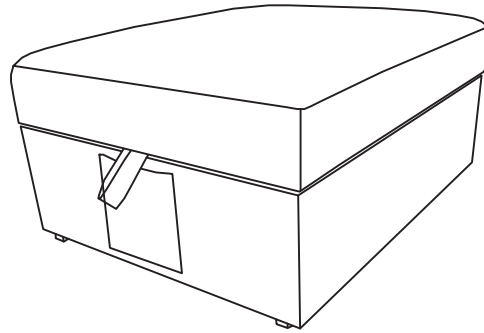

## PARTS LIST

**A**

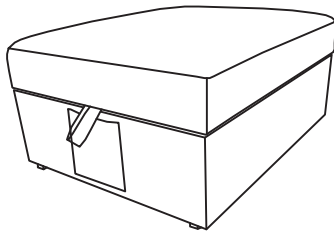

**X1**

**D**

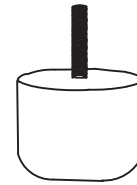

**LEG**

**X4**

Step1

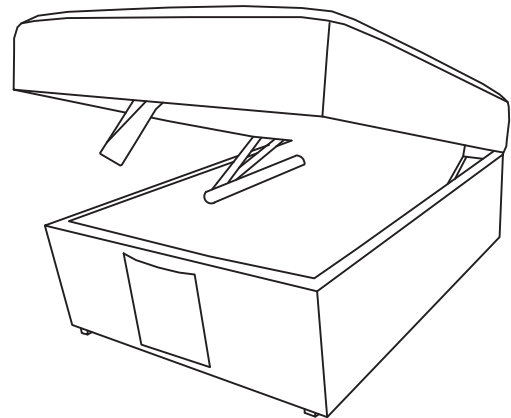
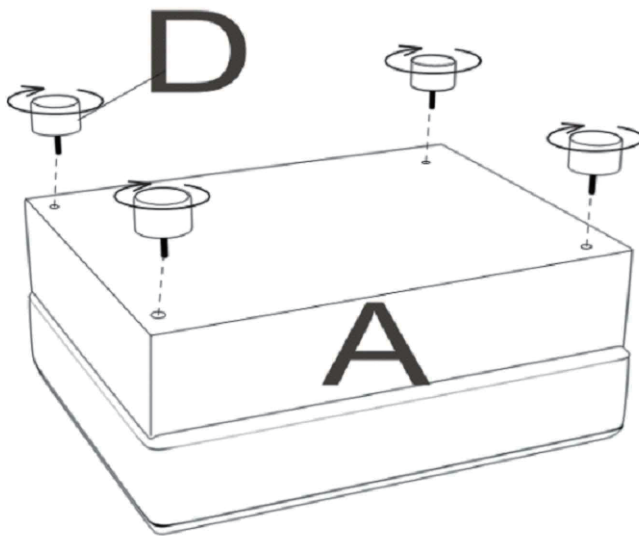

# ASSEMBLY INSTRUCTION

ITEM NO.: 81803-ARM

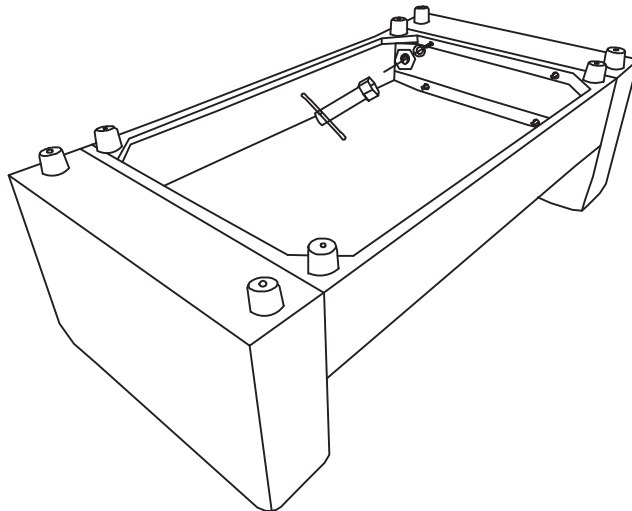
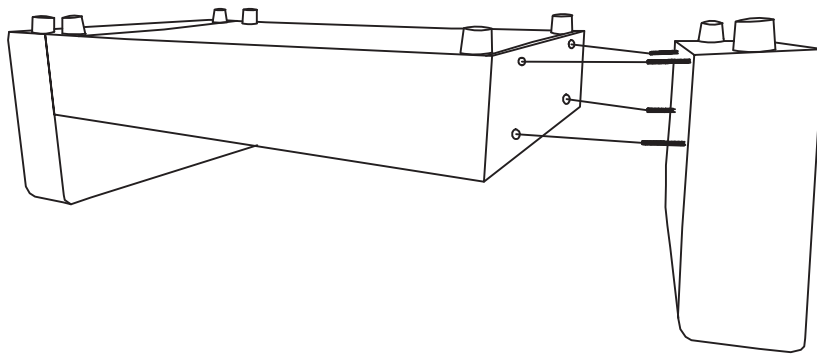
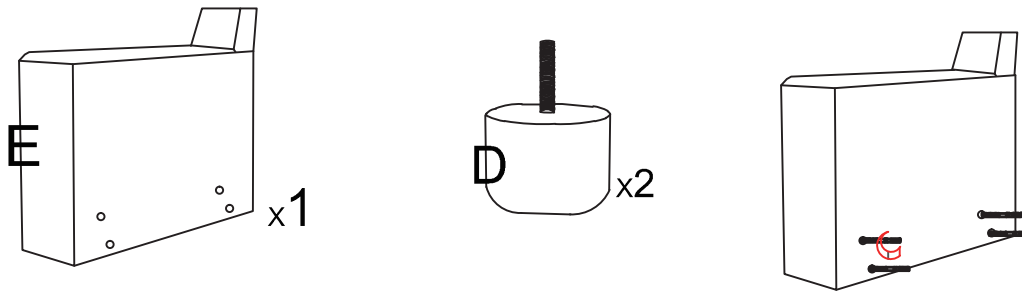

1

x4



2

x4



3

x4

4

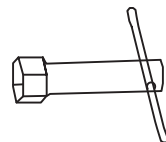

x1