

ASSEMBLY INSTRUCTION

ITEM NO.: 81803-LS

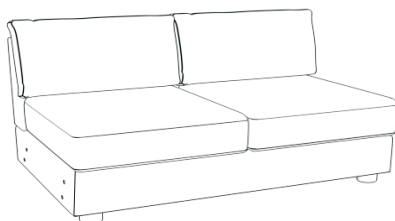

PARTS LIST

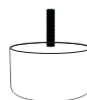
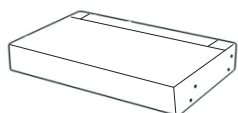

A

x1

B

x1

D

Leg

x4

5

x2

Open up Velcro of Non-Woven Fabric cover on the bottom of the seat frame to remove **seat cushions, Back cushions and legs**

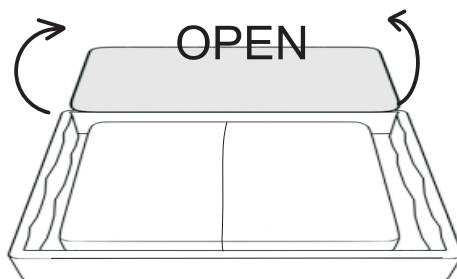

2-SEAT ASSEMBLY INSTRUCTION

Step1

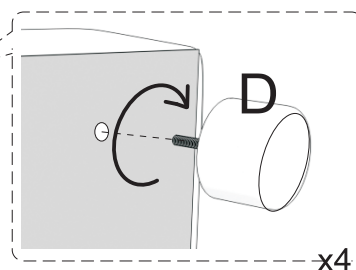
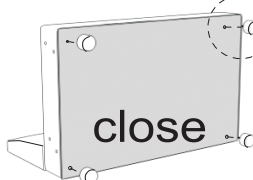
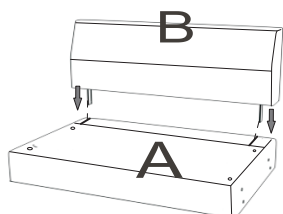

81803-LS

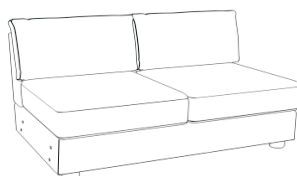

ASSEMBLY INSTRUCTION

ITEM NO.: 81803-ARM

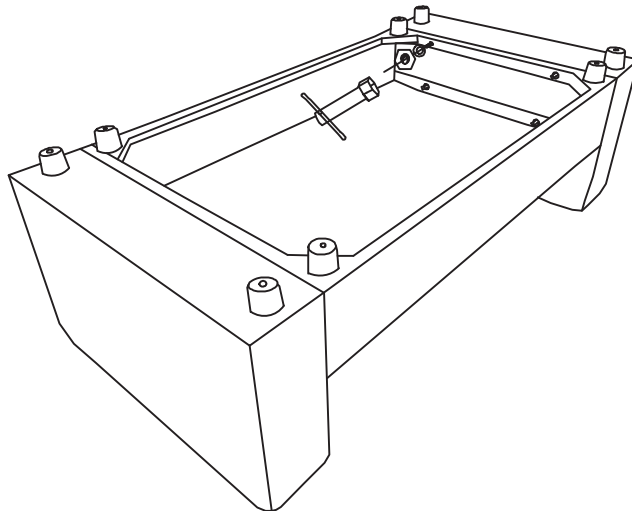
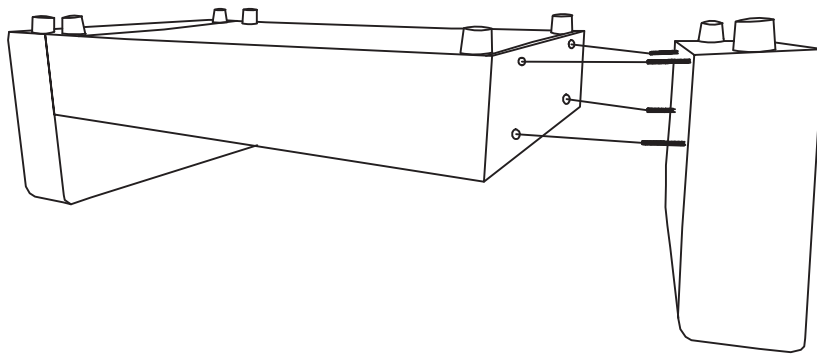
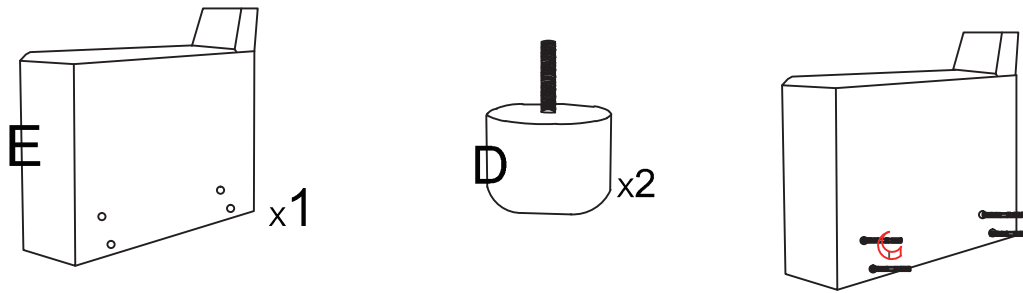

1

x4



2

x4



3

x4

4

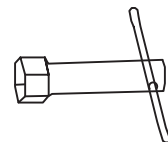

x1

ASSEMBLY INSTRUCTION

ITEM NO.: 81803-A

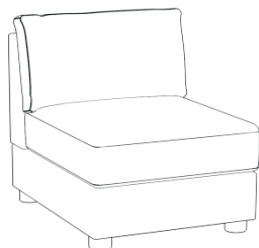

PARTS LIST

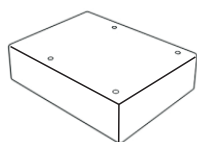

A

x1

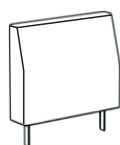

B

x1



D

Leg

x4



5

x2

Open up Velcro of Non-Woven Fabric cover on the bottom of the seat frame to remove **seat cushions, Back cushions and legs.**

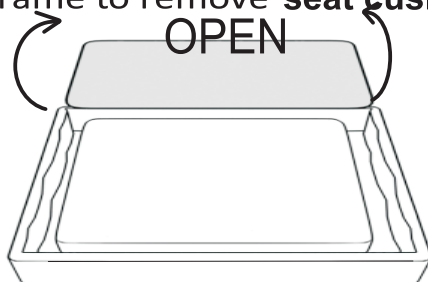

ASSEMBLY INSTRUCTION

Step1

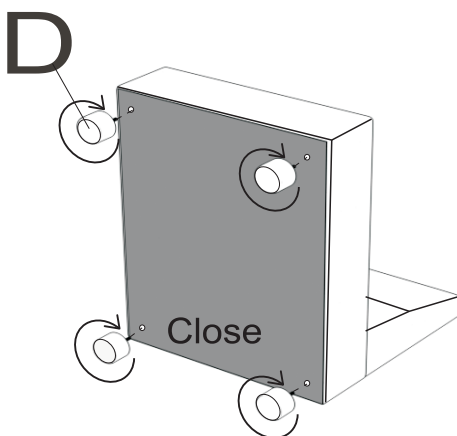
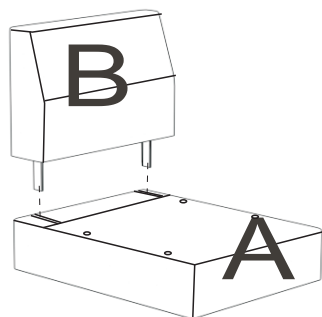



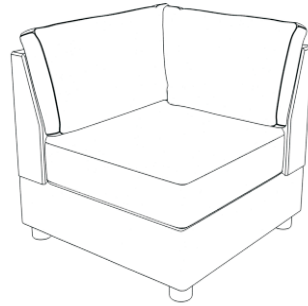

ASSEMBLY INSTRUCTION

ITEM NO.: 81803-C

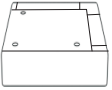

PARTS LIST

										
A	x1	B	x1	C	x1	D	Leg	x4	5	x2

Open up Velcro of Non-Woven Fabric cover on the bottom of the seat frame to remove **seat cushions, Back cushions and legs.**

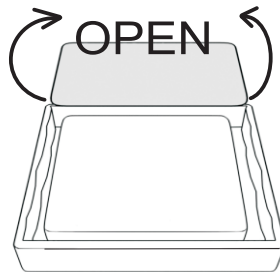

Step1

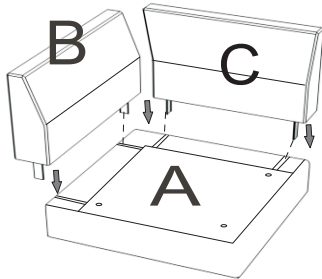

Step2

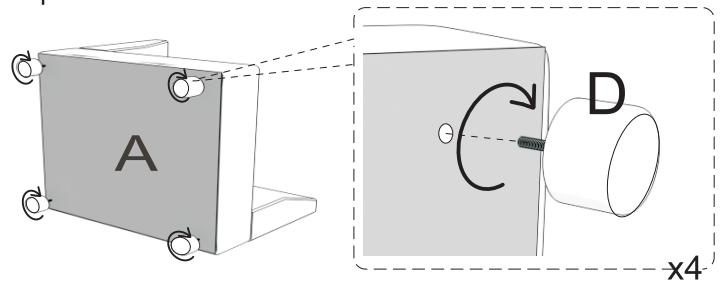

Step3

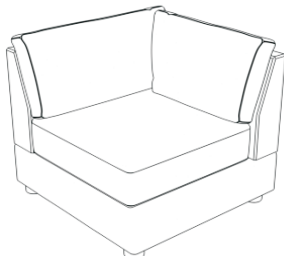

ASSEMBLY INSTRUCTION

ITEM NO.: 81803-O

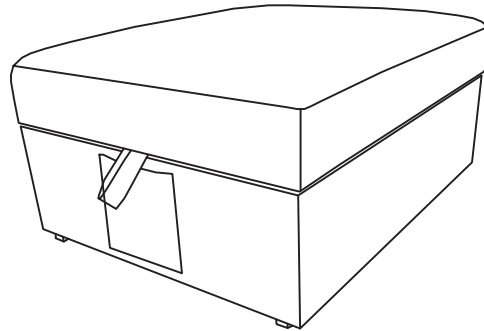

PARTS LIST

A

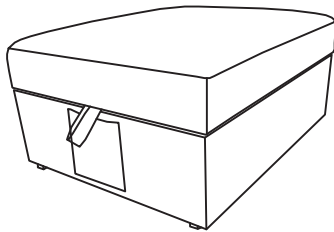

X1

D

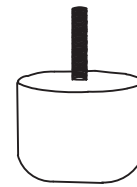

LEG

X4

Step1

