

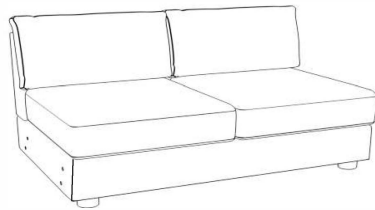

ASSEMBLY INSTRUCTION

ITEM NO.: 81803-LS

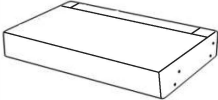
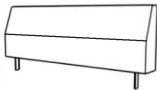

PARTS LIST

			
A x1	B x1	D Leg x4	5 x2

Open up Velcro of Non-Woven Fabric cover on the bottom of the seat frame to remove **seat cushions, Back cushions and legs**

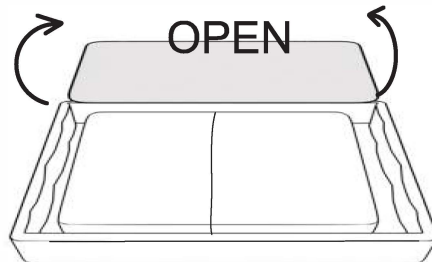

2-SEAT ASSEMBLY INSTRUCTION

Step1

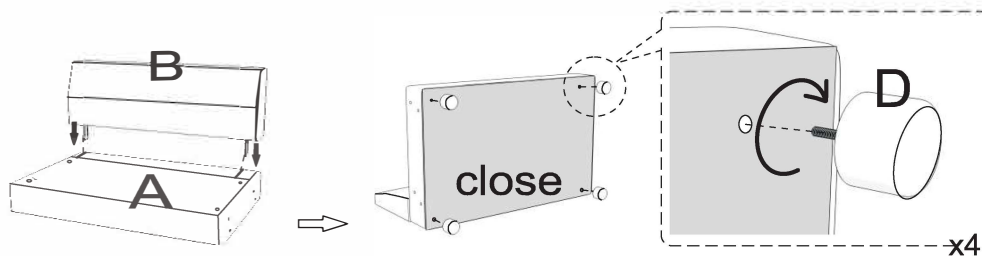

81803-LS

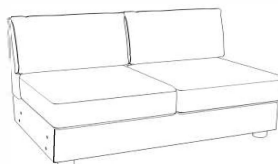

ASSEMBLY INSTRUCTION

ITEM NO.: 81803-ARM

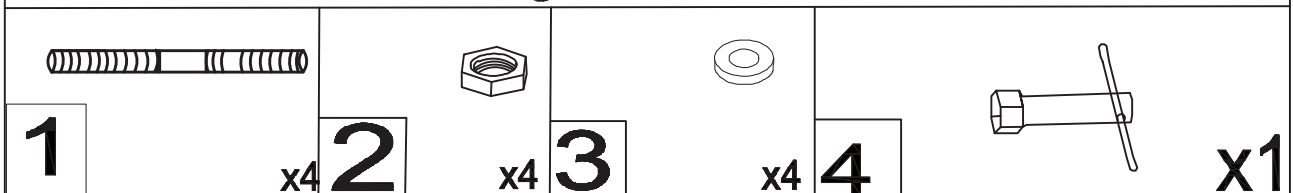
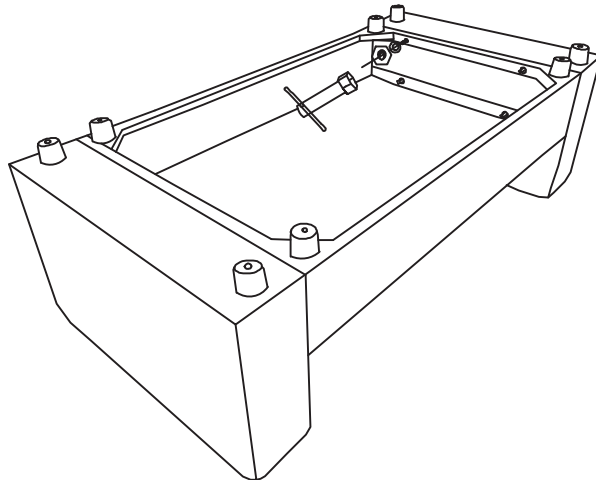
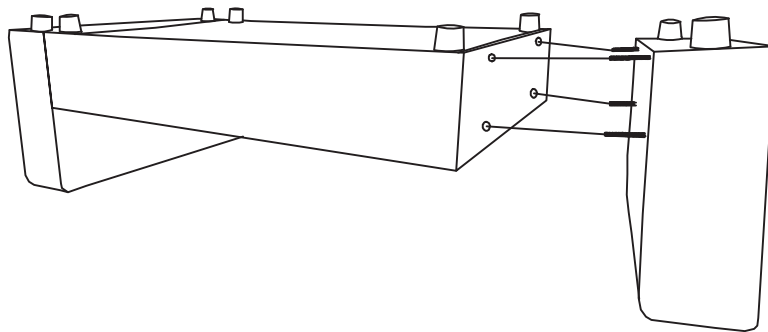
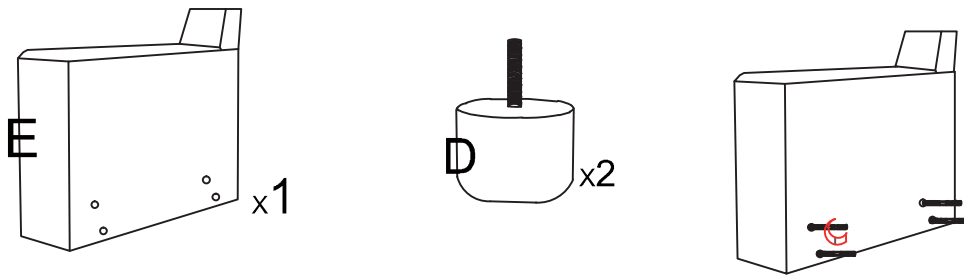

ASSEMBLY INSTRUCTION

ITEM NO.: 81803-A



PARTS LIST



A

x1



B

x1



D

Leg

x4



5

x2

Open up Velcro of Non-Woven Fabric cover on the bottom of the seat frame to remove **seat cushions, Back cushions and legs.**

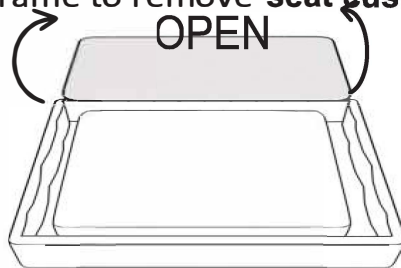

ASSEMBLY INSTRUCTION

Step1

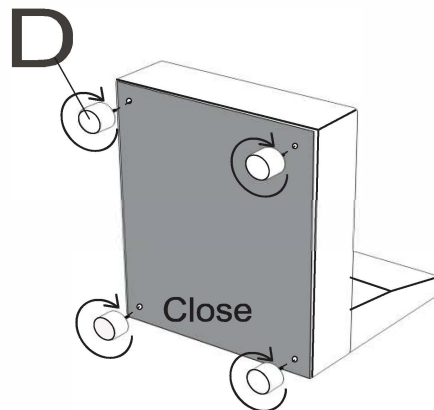
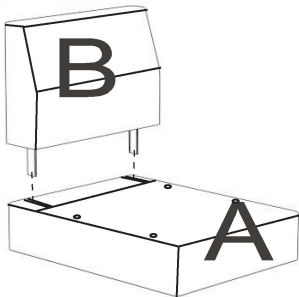





ASSEMBLY INSTRUCTION

ITEM NO.: 81803-C

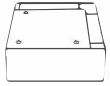

PARTS LIST

									
A	x1	B	x1	C	x1	D Leg	x4	5	x2

Open up Velcro of Non-Woven Fabric cover on the bottom of the seat frame to remove **seat cushions, Back cushions and legs.**

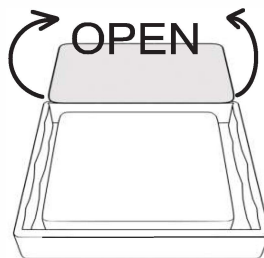

Step1

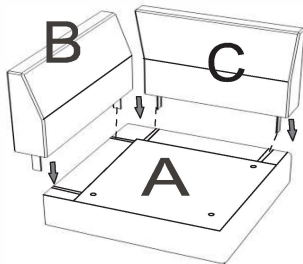

Step2

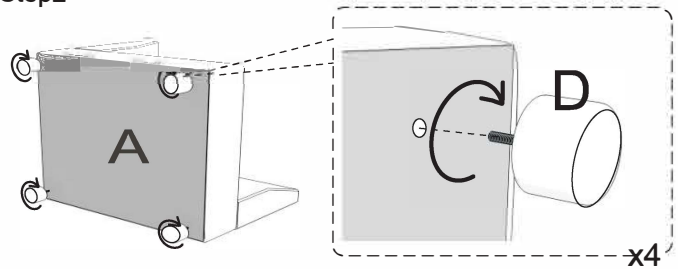

Step3

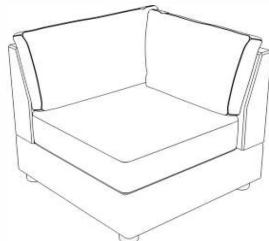

ASSEMBLY INSTRUCTION

ITEM NO.: 81803-O

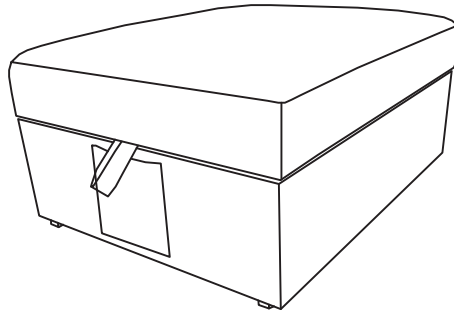

PARTS LIST

A

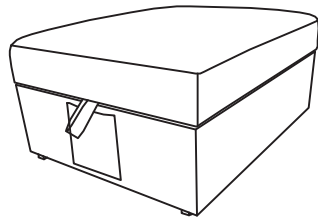

X1

D

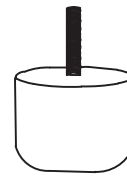

LEG

X4

Step1

