

ASSEMBLY INSTRUCTION

ITEM NO.: 81803-LS

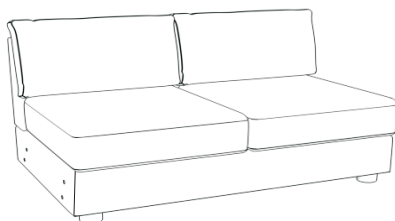

PARTS LIST

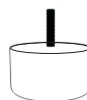
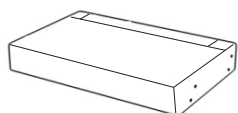

A

x1

B

x1

D

Leg

x4

5

x2

Open up Velcro of Non-Woven Fabric cover on the bottom of the seat frame to remove **seat cushions, Back cushions and legs**

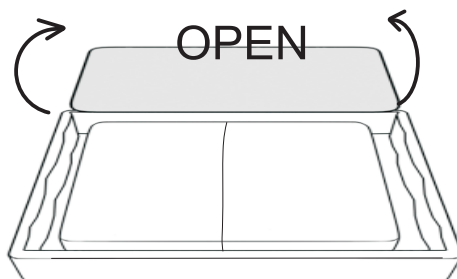

2-SEAT ASSEMBLY INSTRUCTION

Step1

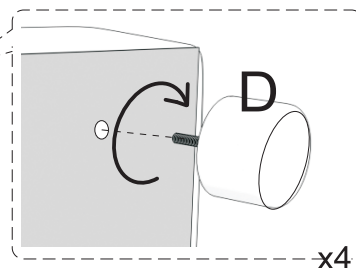
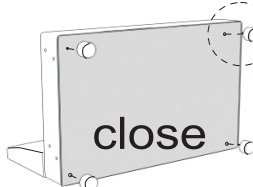
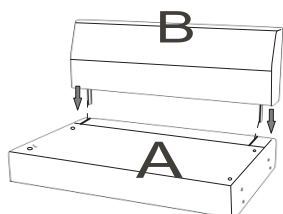

81803-LS

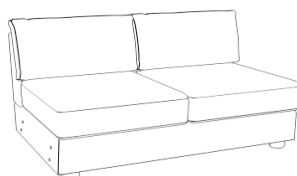



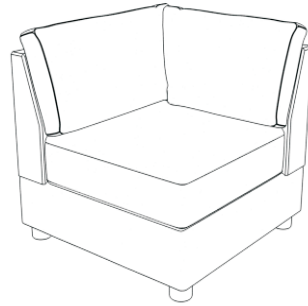

ASSEMBLY INSTRUCTION

ITEM NO.: 81803-C

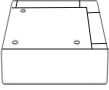

PARTS LIST

										
A	x1	B	x1	C	x1	D	Leg	x4	5	x2

Open up Velcro of Non-Woven Fabric cover on the bottom of the seat frame to remove **seat cushions, Back cushions and legs.**

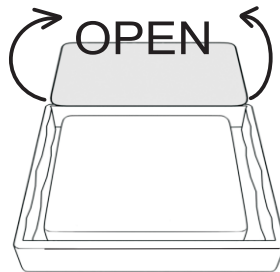

Step1

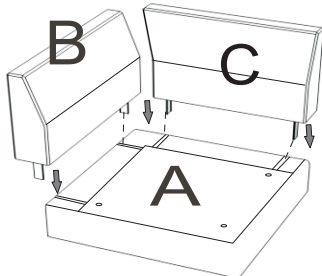

Step2

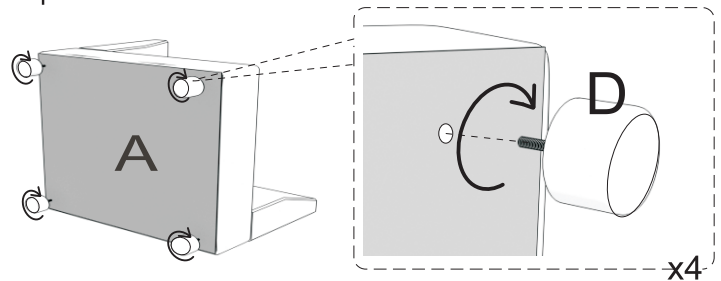

Step3

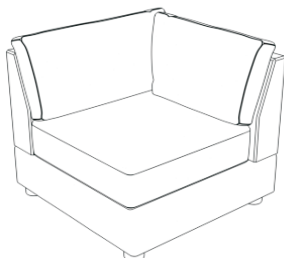

ASSEMBLY INSTRUCTION

ITEM NO.: 81803-CH

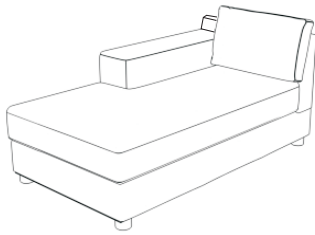

81803-CH

LEFT

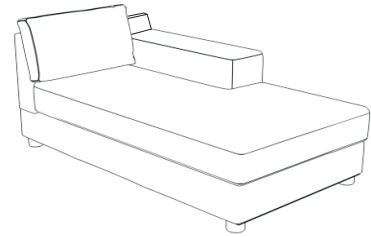

81803-CH

RIGHT

PARTS LIST

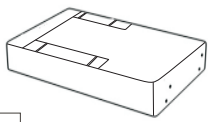

A

x1



B

x1



C

x1



D

Leg

x4

Open up Velcro of Non-Woven Fabric cover on the bottom of the seat frame to remove **seat cushions, back cushions and legs**



LEFT CHAISE ASSEMBLY INSTRUCTION

Step1

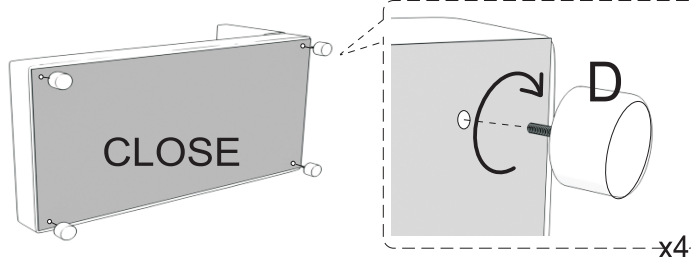
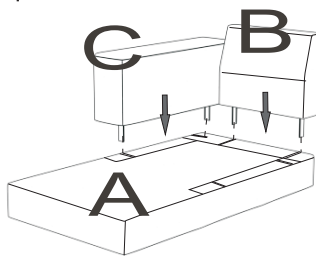

81803-CH

LEFT

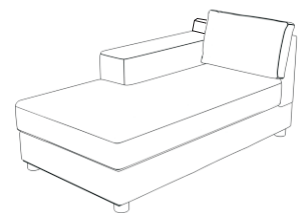

RIGHT CHAISE ASSEMBLY INSTRUCTION

Step1

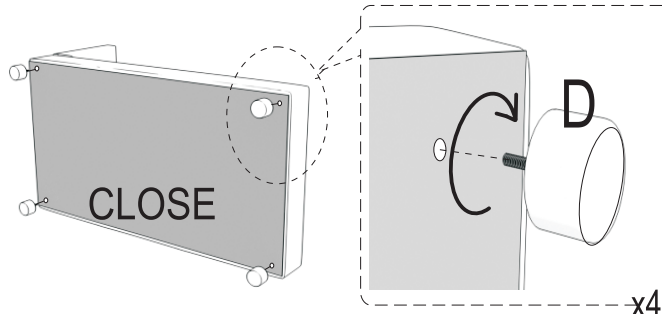
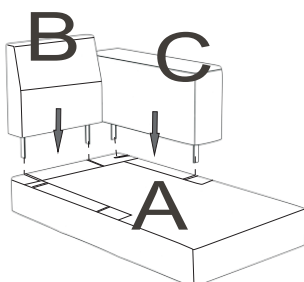

81803-CH

RIGHT

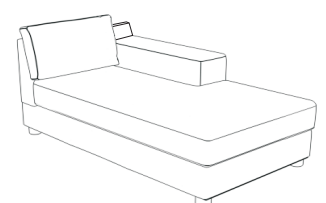

ASSEMBLY INSTRUCTION

ITEM NO.: 81803-ARM

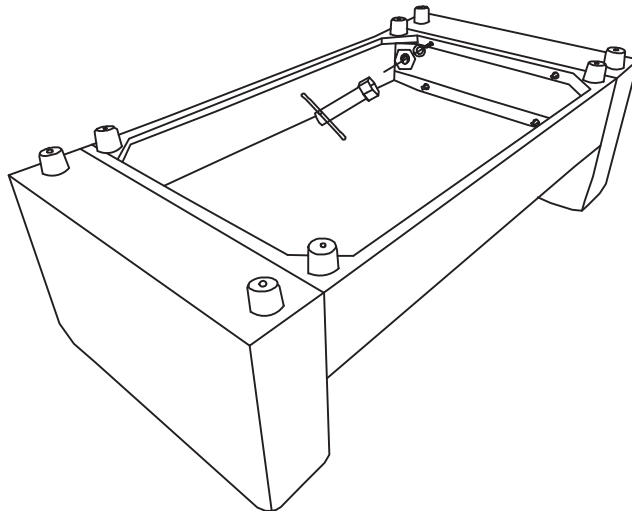
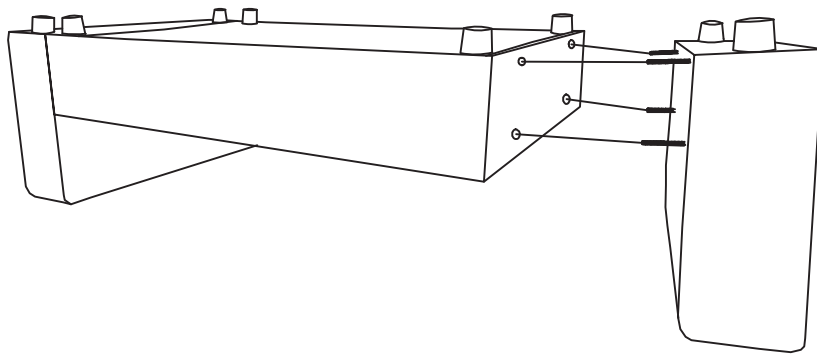
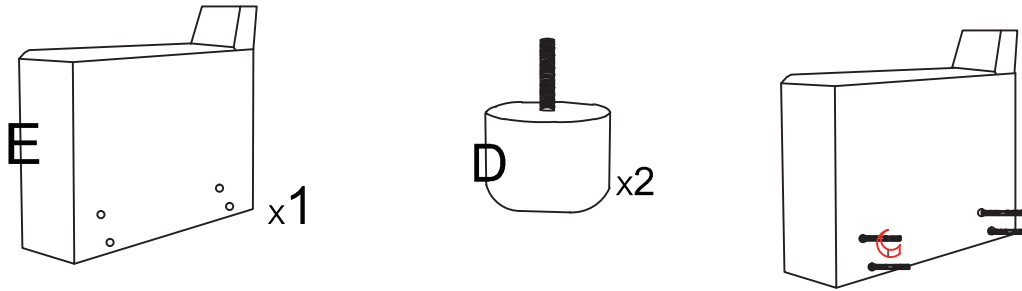

1

x4



2

x4



3

x4

4

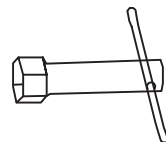

x1