









81801-7 PARTS		Quantity
 81801-LS RIGHT ARM		x1
 81801-A		x2
 81801-C		x1
 81801-O		x2

81801-7 RIGHT 3-SEAT SOFA

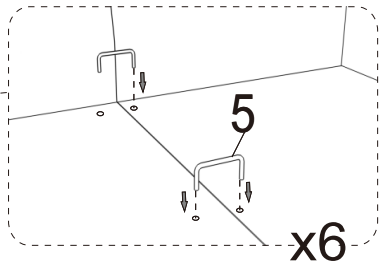
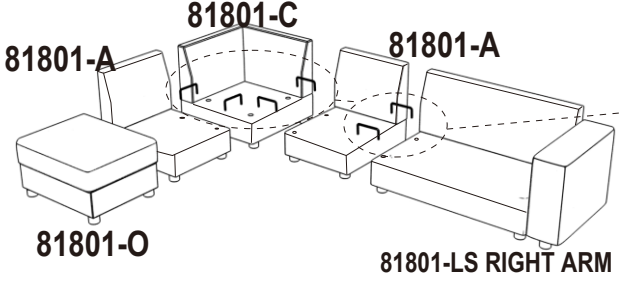

81801-7 PARTS		Quantity
 81801-LS LEFT ARM		x1
 81801-A		x2
 81801-C		x1
 81801-O		x2

81801-7 LEFT 3-SEAT SOFA

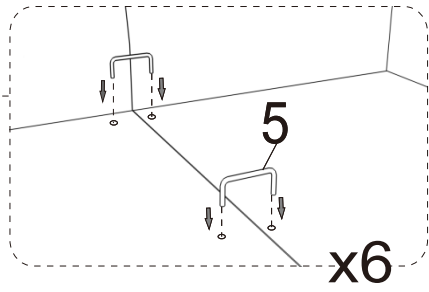
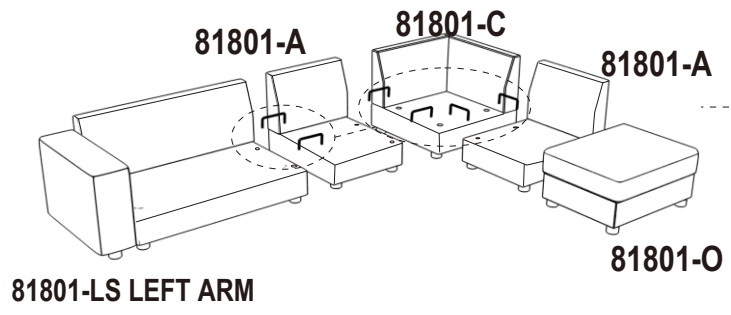

ASSEMBLY INSTRUCTIONS

ITEM NO.: 81801-LS/81802-LS

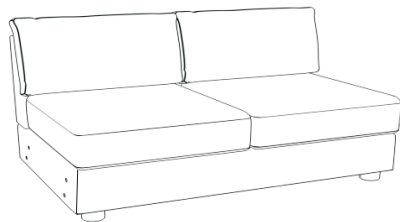

PARTS LIST

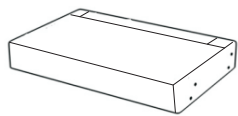

A

x1



B

x1



D Leg

x4



5

x2

Open up Velcro of Non-Woven Fabric cover on the bottom of the seat frame to remove **seat cushions, Back cushions and legs**

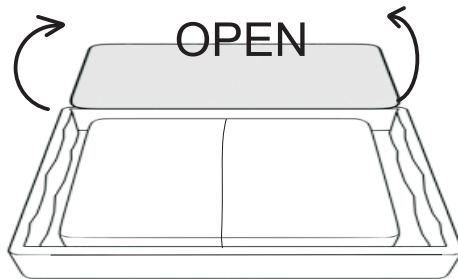

2-SEAT ASSEMBLY INSTRUCTION

Step1

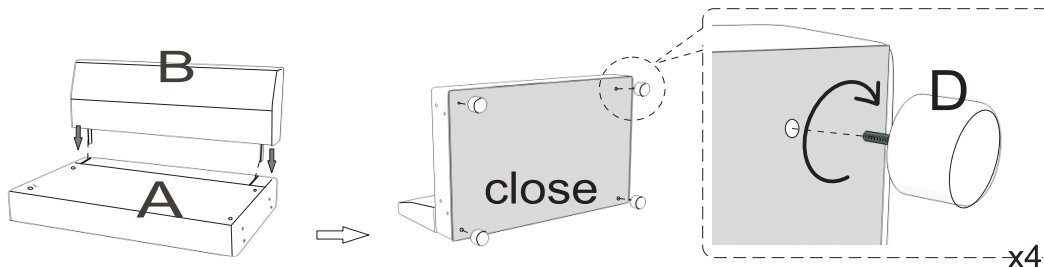

81801-LS/81802-LS

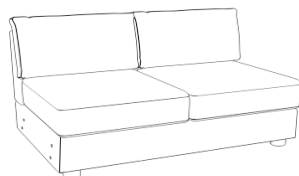

ASSEMBLY INSTRUCTIONS

ITEM NO.: 81801-C/81802-C



PARTS LIST

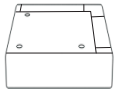

A

x1

B

x1

C

x1

D

Leg

x4

5

x2

Open up Velcro of Non-Woven Fabric cover on the bottom of the seat frame to remove **seat cushions**, **Back cushions** and **legs**.

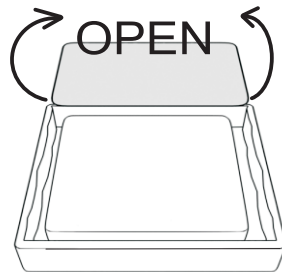

Step1

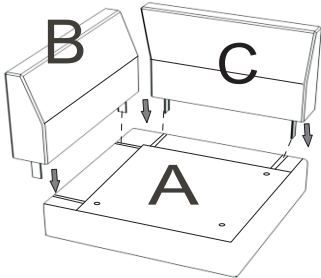

Step2

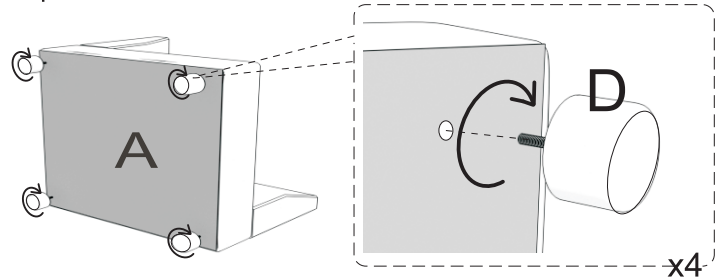

Step3

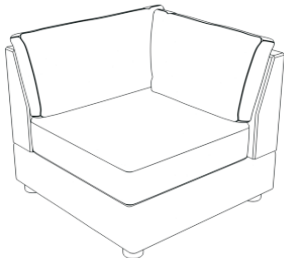

ITEM NO.: 81801-ARM/81802-ARM

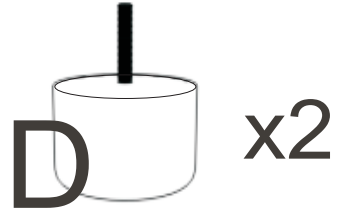
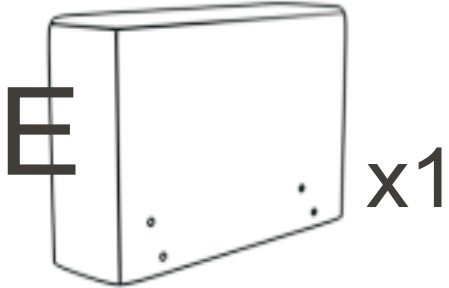

HARDWARE



1

x4



2

x4

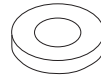

3

x4

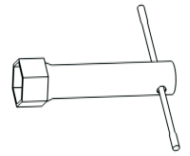

4

x1

ASSEMBLY INSTRUCTIONS

ITEM NO.: 81801-A/81802-A

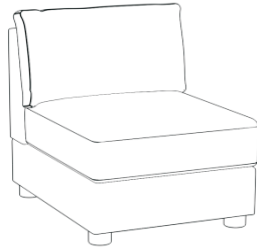

PARTS LIST

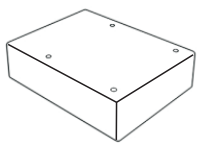

A

x1



B

x1



D

Leg

x4



5

x2

Open up Velcro of Non-Woven Fabric cover on the bottom of the seat frame to remove **seat cushions, Back cushions and legs.**

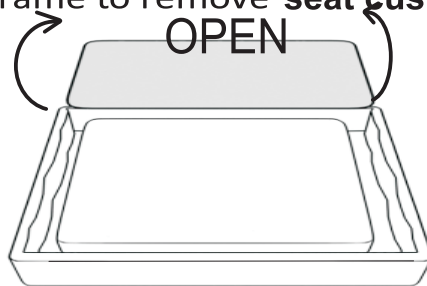

ASSEMBLY INSTRUCTION

Step1

