

ASSEMBLY INSTRUCTIONS

ITEM : 30037 ALOUETTE ROUND DINING TABLE

Please read instructions carefully

Remove all wrapping materials, staples and packing straps from the carton. Refer to Parts List and Hardware List and ensure they are complete before you start assembling. Place all wooden parts on a clean, flat and soft surface (e.g carpet or rug) to prevent parts from being scratched.

CAUTIONS: 1) DO NOT FULLY TIGHTEN BOLTS AND NUTS UNTIL ALL PARTS HAVE BEEN ASSEMBLED.

2) DO NOT OVER-TIGHTEN BOLTS AND NUTS UNTIL ALL PARTS HAVE BEEN ASSEMBLED.

3) KEEP ALL HARDWARE PARTS OUT OF REACH OF CHILDREN.





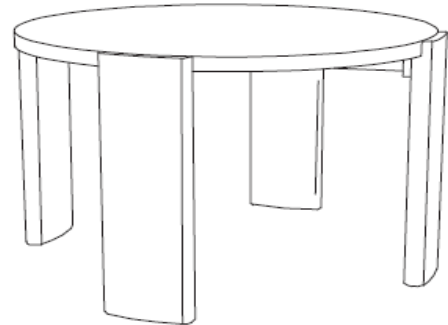

PARTS LIST

NO.	COMPONENT	QTY.
P1	TABLE TOP	1
P2	TABLE LEG	4



COMPLETE ASSEMBLY

HARDWARE LIST

NO.	DESCRIPTION	QTY.
H1	M6X40MM JCBC SCREW 	16
H2	SPRING WASHER 	16
H3	FLAT WASHER 	16
H4	WOOD DOWEL M8 x 30mm 	8
H5	LEGS ADJUSTABLE GLIDE 	8
H6	ALLEN KEY 	1

* MALLET (NOT PROVIDED)

While you prepare the Table Top (P1) by placing it upside-down on a flat, soft & clean surface,

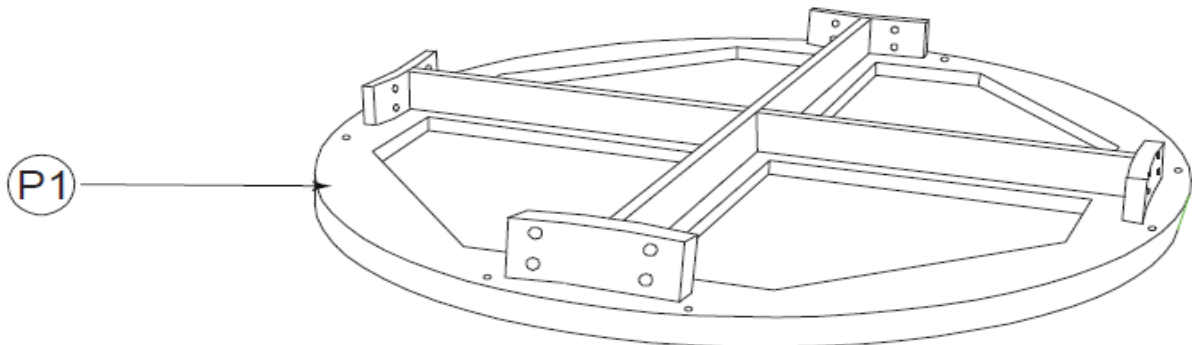

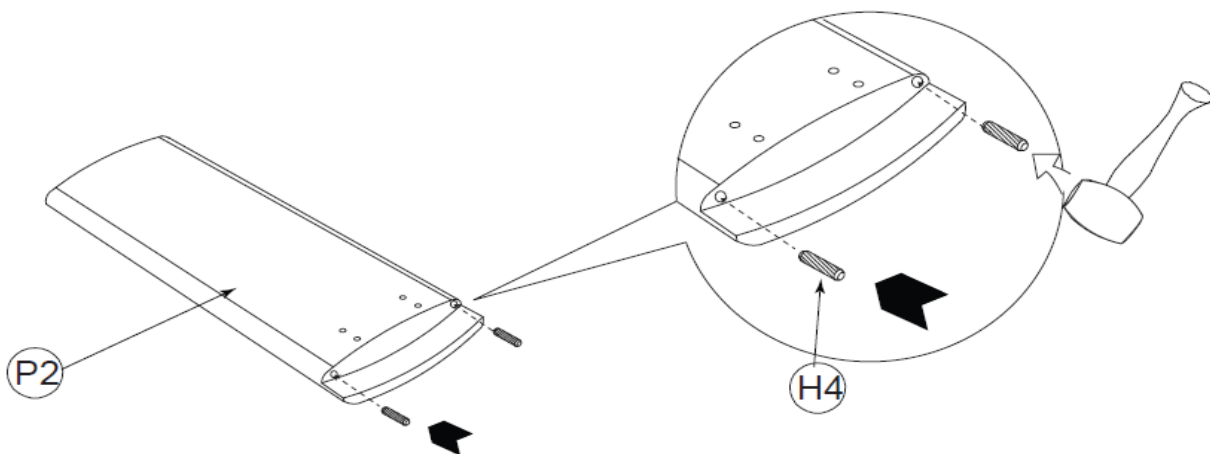

STEP 1

H4 x 8 
M8 x 30mm



Get all the Table leg (P2) to insert the Wooden dowel (H4) into the designated holes at the Legs, until the dowels snug in each hole.

STEP 2

H1 x 16	
H2 x 16	
H3 x 16	

Assemble the Table legs (P2) one by one by attaching them to the connecting blocks in the Table Top, and make sure the locating wooden dowels are snug in the table leg. Then, Align Bolt (H1) fitted with Spring Washer (H2) & Flat Washer (H3) through the holes in the connecting blocks, respectively. Tighten the bolts using the Allen Key (H6).

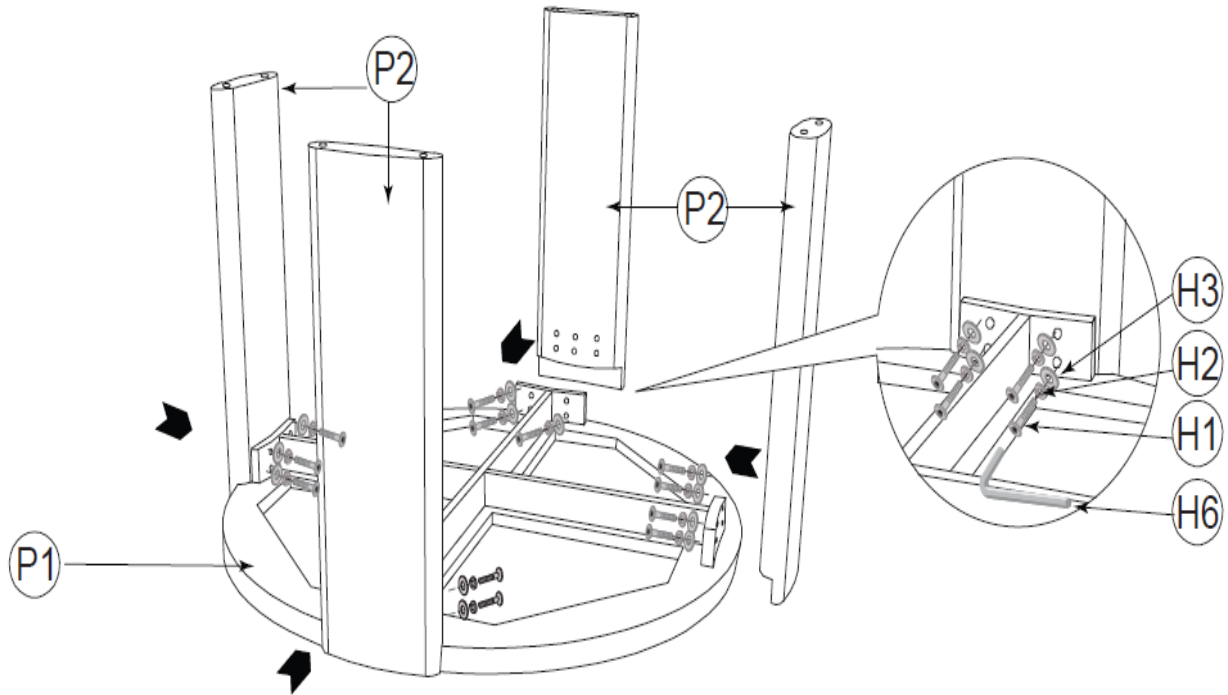

STEP 3

Align the Leg Glide (H5) into nuts in the Leg Base.

H5 x 8	
--------	---

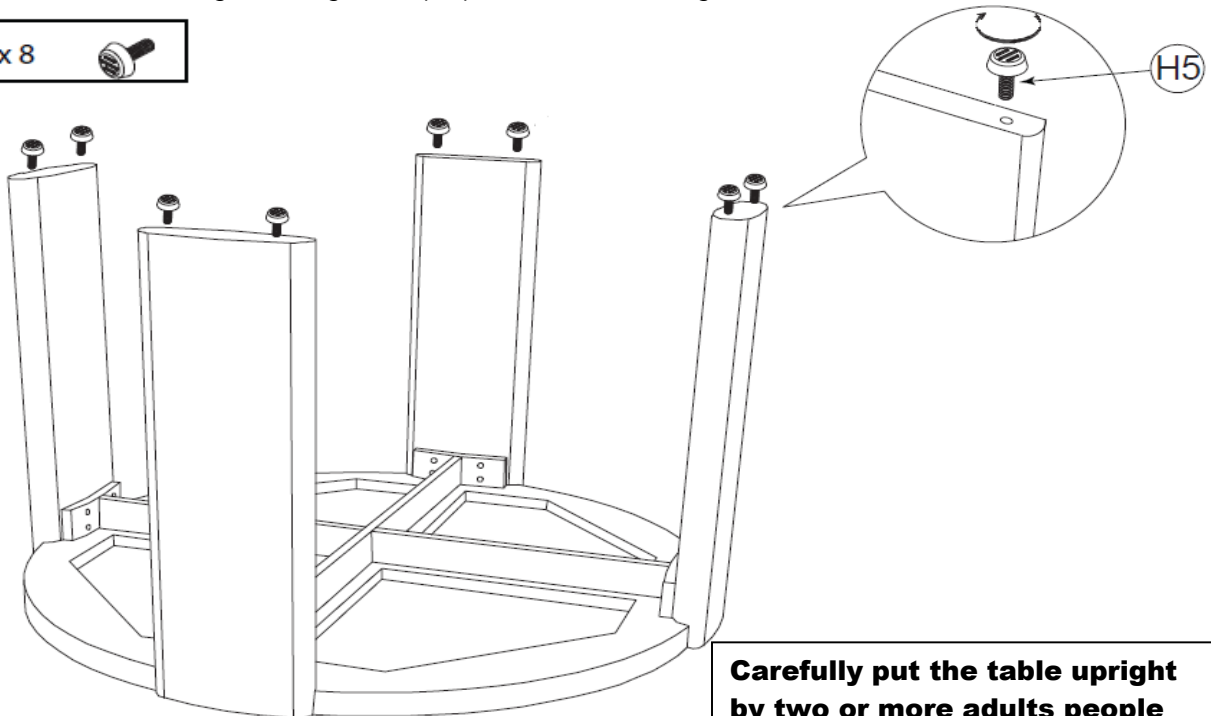

CARE AND MAINTENANCE

SAFETY - To avoid any risk of suffocation to children or animals, dispose off the plastic bags immediately.

CLEANING - Clean with damp cloth and mild detergent. Do not use bleach or abrasive products.

FITTINGS - Tighten bolts and nuts from time to time to ensure all parts of product are securely fitted.