

ASSEMBLY INSTRUCTIONS

1500-103 RECTANGLE COCKTAIL TABLE

LEGACY
CLASSIC | MODERN











Thank you for purchasing this quality product, Before beginning, please check the packing material carefully for small parts which may have come loose inside the carton during shipping. Please do not discard any packing material until all parts have been located. If any part are missing, please contact your dealer for prompt replacement.

Caution: (1) These parts are cumbersome and heavy. This product can best be assembled with the assistance of one or more persons in order to prevent personal injury and to insure parts are not damaged during the assembly process. If dirty, clean finished parts with mild dishwashing liquid and water solution applied on damp cloth. Cloth should not be excessively wet. Polish finish with soft colth and an industry recognized furniture polish

(2)To prevent damage to your floor or carpet, please check the bottom of each piece of furniture for stain residue and rough surfaces and also check for staples or nails left after removing the packaging material. The manufacturer will not be held responsible if preventative step are not taken prior to installation.

(3) During normal use everyday, screws, bolts, nuts and wooden plugs may loosen up. They should be periodically inspected and re-tightened to prevent damage to the furniture and (or) personal property or cause injury. Always check to be sure all hardware on this list and the below mentioned components are attached to the furniture properly and kept tightened.

Part & Hardware List :

PART LIST			QTY	HARDWARE LIST			QTY	HARDWARE LIST			QTY
A	COCKTAIL TABLE BOX		1PC	1	UMBRELLA BOLT		4 PCS	4	LOCK WASHER		18 PCS
B	HANDLE		2PCS	2	ALLEN SHORT BOLT		12 PCS	5	FLAT WASHER		18 PCS
C	SIDE LEG		2PCS	3	ALLEN LONG BOLT		6 PCS	6	ALLEN WRENCH		1 PC
D	SHELF		1PC								

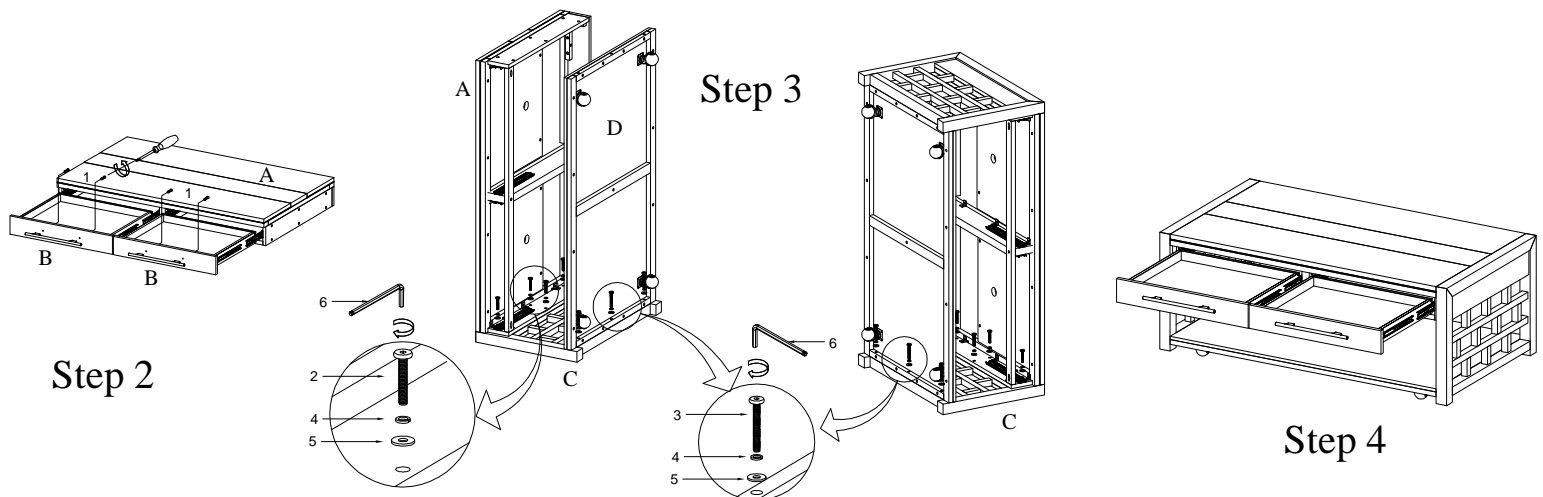

Assembly Procedures :

Step 1 : Lay out all parts and hardware on a clean protective surface to protect the furniture and floor during assembly. Make sure the quantity of each is correct and the feet are free of stains, staples, screw and nails.

Step 2 : Place the cocktail table box (A) on a clean soft surface such as a blanket and ensure the surface is clear of any object that could scratch or damage the cocktail table box, pull out the drawer box from the cocktail table box for makes easy installation. Installing handle (B) to drawer using hardware (1) as shown.

Step 3 : Place side leg (C) on a clean soft surface, assemble the cocktail table box (A), side leg (C) and shelf (D) using hardware (2,3,4,5,6) as shown. Repeat on the other side.

Step 4 : Put back the drawer as before, assembly is complete.